

ALLEGATO B

**Specifiche tecniche per la fornitura
delle Dichiarazioni Precompilate**

Schema **fornituraP73_2017_v1.xsd**

schema location: [fornituraP73_2017_v1.xsd](#)
 attribute form default: **unqualified**
 element form default: **qualified**
 targetNamespace: **urn:www.agenziaentrate.gov.it:specificheTecniche:sco:p73**

Elements Complex types
Fornitura [Esito Richiesta Type](#)
 [Intestazione P73 Type](#)

schema location: [documentoP73_2017_v1.xsd](#)
 attribute form default: **unqualified**
 element form default: **qualified**
 targetNamespace: **urn:www.agenziaentrate.gov.it:specificheTecniche:sco:p73**

Complex types

[Acconti Altri Dati Type](#)
[Acconti Irpef Anno Imposta Type](#)

[Acconti Ritenute Type](#)
[Acconti Compensati Intern Type](#)
[Acquisto Costruzione Abit Locazione](#)
[Addizionali Type](#)
[Altre Detrazioni Type](#)
[Altre Ritenute Type](#)
[Altre Spese Type](#)
[Altri Dati Type](#)
[Altri Oneri Type](#)
[Altri Redditi Ass Lav Type](#)
[Altri Redditi Diversi Detr Type](#)
[Altri Redditi Diversi Type](#)
[Altri Redditi Lavoro Autonomo Type](#)
[Altri Redditi Type](#)
[Altri Redditi Utili Type](#)
[Assegno Coniuge Type](#)
[Bonus Irpef Type](#)
[Casella Acconto Type](#)
[Cedolare Secca Type](#)
[Conguaglio Type](#)
[Contributi Previdenza Complementare Type](#)
[Contributo Solidarieta Type](#)
[Cred Erogazione Cultura Type](#)
[Cred Imp Estero Type](#)
[Crediti F24 Type](#)
[Crediti Imposta Altri Sisma Abruzzo Type](#)
[Crediti Imposta Fabbicati Type](#)
[Crediti Imposta Fondi Pensione Type](#)
[Crediti Imposta Redditi Esteri Type](#)
[Crediti Imposta Type](#)
[Credito Erogazioni Cultura Type](#)
[Credito Erogazioni Scuola Type](#)
[Credito Immobile Sisma Abruzzo Type](#)
[Credito Negoziazione Type](#)
[Credito Stato Type](#)
[Credito Type](#)
[Credito Videosorveglianza Type](#)
[Dati 730 Integrativo Type](#)
[Dati Altre Detrazioni Modulo Type](#)

Simple types

[Anno Anticipazione Fondo Pensione Type](#)
[Anno Patrimonio Edilizio Situazioni Particolari Type](#)
[Anno Recupero Patrimonio Edilizio Type](#)
[Anno Risparmio Energetico Type](#)
[Casella Codice Type](#)
[Casi Particolari Fabbicato Type](#)
[Casi Particolari Risp Ener Type](#)
[Casi Particolari Terreni Type](#)
[Codice Altre Detrazioni Type](#)
[Codice Altre Spese Type](#)
[Codice Altri Oneri Type](#)
[Codice Canone Type](#)
[Codice Evento Eccezionale Type](#)
[Codice Spese Rateizzate Anni Precedenti Type](#)
[Codice Spese Rateizzate Type](#)
[Fabbricato Agev Numero Rigo Type](#)
[Indeterminato Determinato Type](#)
[Mesi Type](#)
[Numero Rata Risparmio Energetico Type](#)
[Numero Rate5o10 Type](#)
[Numero RateDa1A3 Type](#)
[Numero RateDa1A7 Type](#)
[Periodo Spese Ristrutturazione Type](#)
[Rate10 Type](#)
[Rate5 Type](#)
[Rate Risparmio Energetico Type](#)
[Reintegro Totale Parziale Type](#)
[Rideterminazione Rate Type](#)
[Ripart Risparmio Energetico Type](#)
[Serie Registrazione Contratto Type](#)
[Terreni Urbano Type](#)
[Tipo Inquilino Type](#)
[Tipo Intervento Type](#)
[Tipo Reddito Da1a12 Type](#)
[Tipo Reddito Da1a3 Type](#)
[Tipo Reddito Da1a4 Type](#)
[Tipo Reddito Da1a6 Type](#)
[Tipo Reddito Da1a8 Type](#)
[Tipo Reddito Da1a9 Type](#)
[Titolo Terreno Type](#)
[Utilizzo Fabbicato Type](#)

[Dati Altre Detrazioni Type](#)
[Dati Catastali Recupero Patrimonio Edilizio Type](#)
[Dati Catastali Type](#)
[Dati Coniuge Type](#)
[Dati Contabili Type](#)
[Dati Contratto Type](#)
[Dati Familiare Type](#)
[Dati Nascita PF Type](#)
[Dati Primo Figlio Type](#)
[Dati Registrazione Accatastamento Recupero Patrimonio Edilizio Type](#)
[Debito Type](#)
[Deduzioni Modulo Type](#)
[Deduzioni Type](#)
[Detrazione Crediti Type](#)
[Detrazioni Canoni Locazione Type](#)
[Detrazioni Modulo Type](#)
[Detrazioni Type](#)
[Documento P73 Type](#)
[Domanda Accatastamento Type](#)
[Domicilio Fiscale Acconto Type](#)
[Domicilio Fiscale Type](#)
[Eccedenze Oltre Anno Type](#)
[Eccedenze Type](#)
[Elemento Integrativo Type](#)
[Esenzione Add Comunale Type](#)
[Esenzione Bonus Type](#)
[Esito Liquidazione Type](#)
[Fabbricato Agev Type](#)
[Fabbricato Ord Type](#)
[Familiari Type](#)
[Fondo Pensione Dipendenti Pubblici Type](#)
[Frontespizio 730 Type](#)
[Giorni Percentuale Type](#)
[Imposta Lorda Type](#)
[Imposta Netta Type](#)
[Imposte Rimborsate Type](#)
[Incremento Produttività Type](#)
[Inquilini Abitazione Principale Type](#)
[Intervento Recupero Patrimonio Edilizio Type](#)
[Intervento Risparmio Energetico Type](#)
[Iva Acquisto Abitazione Type](#)
[Lavoro Dipendente Type](#)
[Misura Acconti Type](#)
[Modulo Altri Redditi Type](#)
[Modulo Crediti Imposta Type](#)
[Modulo Credito Negoziazione Type](#)

[Modulo Fabbricato Type](#)
[Modulo Familiari Type](#)
[Modulo Lavoro Dip Type](#)
[Modulo Oneri Type](#)
[Modulo PL Type](#)
[Modulo Terreno Type](#)
[N Rate Type](#)
[Oneri Non Abbattuti Type](#)
[Oneri Type](#)
[Opzione Produttivita Type](#)
[Periodo Di Lavoro Type](#)
[Premi Risultato Modulo Type](#)
[Premi Risultato Type](#)
[Primo Modulo Acconti Ritenute Type](#)
[Primo Modulo Crediti Imposta Type](#)
[Primo Modulo Familiari Type](#)
[Primo Modulo Lavoro Dip Type](#)
[Primo Modulo Oneri Type](#)
[Primo Modulo PL Type](#)
[Prospetto Liquidazione Type](#)
[Prospetto Type](#)
[Redditi Capitale Type](#)
[Redditi Eredi Legatari Type](#)
[Redditi Fabbricati Type](#)
[Redditi Lavoro Dip Type](#)
[Redditi Ritenute Spese Type](#)
[Redditi Ritenute Type](#)
[Redditi Tassazione Separata Type](#)
[Redditi Terreni Type](#)
[Reddito Erede Type](#)
[Residuo Credito Compens AnnoImposta Type](#)
[Residuo Credito Compens Type](#)
[Residuo Fabbricati Type](#)
[Restituzione Somme Type](#)
[Riepilogo Redditi Type](#)
[Ritenute Acconti Sospesi Type](#)
[Ritenute Lavoro Dip Type](#)
[Sezione Altri Redd Type](#)
[Sezione Dati Catastali Recupero Patrimonio Edilizio Type](#)
[Sogetto Fiscale 730 Type](#)
[Soglie Esenzione Type](#)
[Spese Arredo Giovani Coppie Type](#)
[Spese Arredo Type](#)
[Spese Leasing Type](#)
[Spese Rateizzate Anni Precedenti Type](#)
[Spese Rateizzate Type](#)

[Tassazione Separata Type](#)[Terreno Type](#)

schema location: [sintetico730_2017.xsd](#)
 attribute form default: **unqualified**
 element form default: **qualified**
 targetNamespace: **urn:www.agenziaentrate.gov.it:specificheTecniche:sco:p73**

Elements	Complex types	Simple types
ElencoFonti	AnagraficaType	DataType
Sintetico730	DatiAnagraficiType	ImportoType
	DettaglioFonteType	
	DettaglioType	
	ElencoFontiType	
	FonteType	

schema location: [typesDati_v4.xsd](#)
 attribute form default: **unqualified**
 element form default: **qualified**
 targetNamespace: **urn:www.agenziaentrate.gov.it:specificheTecniche:common**

Simple types

- [DatoAN_Type](#)
- [DatoCB12_Type](#)
- [DatoCB_Type](#)
- [DatoCF_Type](#)
- [DatoCN_Type](#)
- [DatoCP_Type](#)
- [DatoD6_Type](#)
- [DatoDA_Type](#)
- [DatoDN_Type](#)
- [DatoDT_Type](#)
- [DatoEM_Type](#)
- [DatoGA_Type](#)
- [DatoN1_Type](#)
- [DatoNP_Type](#)
- [DatoNU_Type](#)
- [DatoPC_Type](#)
- [DatoPI_Type](#)
- [DatoQU_Type](#)
- [DatoTL_Type](#)
- [DatoVP_Type](#)

schema location: [fornitura_v4.xsd](#)
 attribute form default: **unqualified**
 element form default: **qualified**
 targetNamespace: **urn:www.agenziaentrate.gov.it:specificheTecniche:common**

Elements	Complex types	Simple types
Documento	Documento_Type	Identificativo_Type

schema location: [datiFiscali_v5.xsd](#)
attribute form default: unqualified
element form default: qualified
targetNamespace: urn:www.agenziaentrate.gov.it:specificheTecniche:sco:common

Complex types

[Dati_Anagrafici_Type](#)
[Dati_Sottoscrittore_Type](#)
[Domicilio_EE_Type](#)
[Domicilio_Fiscale_Type](#)
[Domicilio_Ita_Type](#)
[Firma_Revisione_Type](#)
[Firma_Type](#)
[Frontespizio_Type](#)
[Impegno_A_Trasmettere_Type](#)
[Persone_Fisiche_Type](#)
[Residenza_Anagrafica_Type](#)
[Residenza_Estera_Type](#)
[Soggetti_Diversi_Da_PF_Type](#)
[Soggetti_Non_Residenti_Type](#)
[Soggetto_Fiscale_Type](#)
[Tipo_Dichiarazione_Type](#)
[Visto_Conformita_Type](#)

schema location: [typesProvincie_v4.xsd](#)
attribute form default: unqualified
element form default: qualified
targetNamespace: urn:www.agenziaentrate.gov.it:specificheTecniche:common

Simple types

[Estero](#)
[PE_Type](#)
[PN_Type](#)
[PR_Type](#)
[ProvincieCroate](#)
[ProvincieItaliane](#)
[ProvincieSoppresse](#)

schema location: [typesFiscali_v5.xsd](#)
attribute form default: unqualified
element form default: qualified
targetNamespace: urn:www.agenziaentrate.gov.it:specificheTecniche:sco:common

Simple types

[Casella_Quadro_Type](#)
[Codice_Carica_Type](#)
[Codice_Regionale_Type](#)
[Natura_Giuridica_Type](#)
[Sesso_Type](#)
[Situazione_Type](#)
[Stato_Type](#)

schema location: [typeEventi_v4.xsd](#)
 attribute form default: **unqualified**
 element form default: **qualified**
 targetNamespace: **urn:www.agenziaentrate.gov.it:specificheTecniche:sco:common**

Simple types
[Eventi Ecc Type](#)

element Fornitura

diagram	
namespace	urn:www.agenziaentrate.gov.it:specificheTecniche:sco:p73
children	p73:Intestazione p73:EsitoRichiesta

element Fornitura/Intestazione

diagram	
namespace	urn:www.agenziaentrate.gov.it:specificheTecniche:sco:p73
type	p73:Intestazione_P73_Type
children	p73:CodiceFornitura p73:TotaleDocRichiesti p73:TotaleDocForniti p73:TotaleDocScartati p73:TotaleDocNonReperiti

element **Fornitura/EsitoRichiesta**

diagram	
namespace	urn:www.agenziaentrate.gov.it:specificheTecniche:sco:p73
type	p73:Esito_Richiesta_Type
children	p73:CodiceFiscaleRichiesta p73:AnagraficaContribuente p73:DocumentoP73 p73:Sintetico730 p73:Stato

complexType **Esito_Richiesta_Type**

diagram	
namespace	urn:www.agenziaentrate.gov.it:specificheTecniche:sco:p73
children	p73:CodiceFiscaleRichiesta p73:AnagraficaContribuente p73:DocumentoP73 p73:Sintetico730 p73:Stato

element **Esito_Richiesta_Type/CodiceFiscaleRichiesta**

diagram	
namespace	urn:www.agenziaentrate.gov.it:specificheTecniche:sco:p73

element **Esito_Richiesta_Type/AnagraficaContribuente**

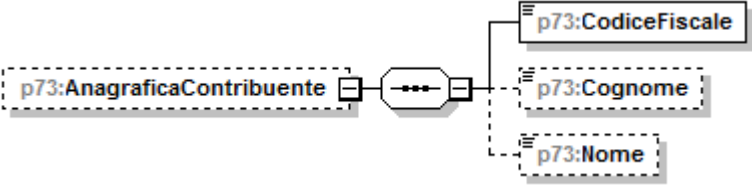
diagram	
namespace	urn:www.agenziaentrate.gov.it:specificheTecniche:sco:p73
children	p73:CodiceFiscale p73:Cognome p73:Nome

element **Esito_Richiesta_Type/AnagraficaContribuente/CodiceFiscale**

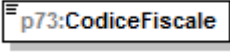
diagram	
namespace	urn:www.agenziaentrate.gov.it:specificheTecniche:sco:p73
type	DatoCF_Type
facets	Kind Value pattern [0-9]{11}[A-Z]{6}[0-9LMNPQRSTU]{2}[A-Z]{1}[0-9LMNPQRSTU]{2}[A-Z]{1}[0-9LMNPQRSTU]{3}[A-Z]{1}

element **Esito_Richiesta_Type/AnagraficaContribuente/Cognome**

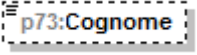
diagram	
namespace	urn:www.agenziaentrate.gov.it:specificheTecniche:sco:p73
type	DatoAN_Type
facets	Kind Value pattern ([0-9A-Z-] \"){1}([0-9A-Z&:] ' \" data-bbox="195 555 725 575"/>

element **Esito_Richiesta_Type/AnagraficaContribuente/Nome**

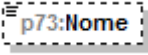
diagram	
namespace	urn:www.agenziaentrate.gov.it:specificheTecniche:sco:p73
type	DatoAN_Type
facets	Kind Value pattern ([0-9A-Z-] \"){1}([0-9A-Z&:] ' \" data-bbox="195 715 725 735"/>

element **Esito_Richiesta_Type/DocumentoP73**

diagram	
namespace	urn:www.agenziaentrate.gov.it:specificheTecniche:sco:p73
type	p73:Documento_P73_Type
children	p73:Frontespizio p73:DatiContabili p73:EsitiContabili

element **Esito_Richiesta_Type/Stato**

diagram					
namespace	urn:www.agenziaentrate.gov.it:specificheTecniche:sco:p73				
type	DatoAN_Type				
facets	<table border="0"> <tr> <td>Kind</td> <td>Value</td> </tr> <tr> <td>pattern</td> <td>(([0-9A-Z-])&quot;){1}([0-9A-Z&amp;:] ' \" _ / ° \" \\(\\) À É Ê Ì Ò Ù Û &quot; \\\" \\ +)*</td> </tr> </table>	Kind	Value	pattern	(([0-9A-Z-])"){1}([0-9A-Z&:] ' \" _ / ° \" \\(\\) À É Ê Ì Ò Ù Û " \\\" \\ +)*
Kind	Value				
pattern	(([0-9A-Z-])"){1}([0-9A-Z&:] ' \" _ / ° \" \\(\\) À É Ê Ì Ò Ù Û " \\\" \\ +)*				

complexType **Intestazione_P73_Type**

diagram	
namespace	urn:www.agenziaentrate.gov.it:specificheTecniche:sco:p73
children	p73:CodiceFornitura p73:TotaleDocRichiesti p73:TotaleDocForniti p73:TotaleDocScartati p73:TotaleDocNonReperiti

element **Intestazione_P73_Type/CodiceFornitura**

diagram	
namespace	urn:www.agenziaentrate.gov.it:specificheTecniche:sco:p73
type	restriction of DatoAN_Type

facets	Kind Value pattern ([0-9A-Z\-_]"){1}([0-9A-Z&:] \" \- \., / ° ^\(\\ \\) À É Ê Ë Ì Ó Ù Ú Û " \\ \\ \\ +)*
--------	---

element Intestazione_P73_Type/TotaleDocRichiesti

diagram	
namespace	urn:www.agenziaentrate.gov.it:specificheTecniche:sco:p73
type	DatoNP_Type
facets	Kind Value pattern [1-9]{1}[0-9]*

element Intestazione_P73_Type/TotaleDocForniti

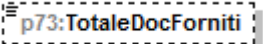
diagram	
namespace	urn:www.agenziaentrate.gov.it:specificheTecniche:sco:p73
type	DatoNP_Type
facets	Kind Value pattern [1-9]{1}[0-9]*

element Intestazione_P73_Type/TotaleDocScartati

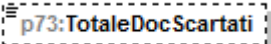
diagram	
namespace	urn:www.agenziaentrate.gov.it:specificheTecniche:sco:p73
type	DatoNP_Type
facets	Kind Value pattern [1-9]{1}[0-9]*

element Intestazione_P73_Type/TotaleDocNonReperiti

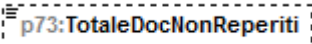
diagram	
namespace	urn:www.agenziaentrate.gov.it:specificheTecniche:sco:p73
type	DatoNP_Type
facets	Kind Value pattern [1-9]{1}[0-9]*

complexType **Acconti_Altri_Dati_Type**

diagram	
namespace	urn:www.agenziaentrate.gov.it:specificheTecniche:sco:p73
children	p73:IncapientiDetrazioneFigli p73:IncapientiDetrazioneLocazione p73:RestituzioneBonusFiscale p73:RestituzioneBonusStraordinario p73:Pignoramento

element **Acconti_Altri_Dati_Type/IncapientiDetrazioneFigli**

diagram					
namespace	urn:www.agenziaentrate.gov.it:specificheTecniche:sco:p73				
type	DatoNP_Type				
facets	<table border="1"> <tr> <td>Kind</td> <td>Value</td> </tr> <tr> <td>pattern</td> <td>[1-9]{1}[0-9]*</td> </tr> </table>	Kind	Value	pattern	[1-9]{1}[0-9]*
Kind	Value				
pattern	[1-9]{1}[0-9]*				

element **Acconti_Altri_Dati_Type/IncapientiDetrazioneLocazione**

diagram					
namespace	urn:www.agenziaentrate.gov.it:specificheTecniche:sco:p73				
type	DatoNP_Type				
facets	<table border="1"> <tr> <td>Kind</td> <td>Value</td> </tr> <tr> <td>pattern</td> <td>[1-9]{1}[0-9]*</td> </tr> </table>	Kind	Value	pattern	[1-9]{1}[0-9]*
Kind	Value				
pattern	[1-9]{1}[0-9]*				

element **Acconti_Altri_Dati_Type/RestituzioneBonusFiscale**

diagram					
namespace	urn:www.agenziaentrate.gov.it:specificheTecniche:sco:p73				
type	DatoNP_Type				
facets	<table border="1"> <tr> <td>Kind</td> <td>Value</td> </tr> <tr> <td>pattern</td> <td>[1-9]{1}[0-9]*</td> </tr> </table>	Kind	Value	pattern	[1-9]{1}[0-9]*
Kind	Value				
pattern	[1-9]{1}[0-9]*				

element Acconti_Altri_Dati_Type/RestituzioneBonusStraordinario

diagram					
namespace	urn:www.agenziaentrate.gov.it:specificheTecniche:sco:p73				
type	DatoNP_Type				
facets	<table border="0"> <tr> <td>Kind</td> <td>Value</td> </tr> <tr> <td>pattern</td> <td>[1-9]{1}[0-9]*</td> </tr> </table>	Kind	Value	pattern	[1-9]{1}[0-9]*
Kind	Value				
pattern	[1-9]{1}[0-9]*				

element Acconti_Altri_Dati_Type/Pignoramento

diagram	
namespace	urn:www.agenziaentrate.gov.it:specificheTecniche:sco:p73
children	p73:TipoRedditoPignoramento p73:RitenutePignoramento

element Acconti_Altri_Dati_Type/Pignoramento/TipoRedditoPignoramento

diagram																	
namespace	urn:www.agenziaentrate.gov.it:specificheTecniche:sco:p73																
type	restriction of DatoN1_Type																
facets	<table border="0"> <tr> <td>Kind</td> <td>Value</td> </tr> <tr> <td>pattern</td> <td>[1-9]</td> </tr> <tr> <td>enumeration</td> <td>1</td> </tr> <tr> <td>enumeration</td> <td>2</td> </tr> <tr> <td>enumeration</td> <td>3</td> </tr> <tr> <td>enumeration</td> <td>4</td> </tr> <tr> <td>enumeration</td> <td>5</td> </tr> <tr> <td>enumeration</td> <td>6</td> </tr> </table>	Kind	Value	pattern	[1-9]	enumeration	1	enumeration	2	enumeration	3	enumeration	4	enumeration	5	enumeration	6
Kind	Value																
pattern	[1-9]																
enumeration	1																
enumeration	2																
enumeration	3																
enumeration	4																
enumeration	5																
enumeration	6																

element Acconti_Altri_Dati_Type/Pignoramento/RitenutePignoramento

diagram					
namespace	urn:www.agenziaentrate.gov.it:specificheTecniche:sco:p73				
type	DatoNP_Type				
facets	<table border="0"> <tr> <td>Kind</td> <td>Value</td> </tr> <tr> <td>pattern</td> <td>[1-9]{1}[0-9]*</td> </tr> </table>	Kind	Value	pattern	[1-9]{1}[0-9]*
Kind	Value				
pattern	[1-9]{1}[0-9]*				

complexType Acconti_Irpef_Anno_Imposta_Type

diagram	
namespace	urn:www.agenziaentrate.gov.it:specificheTecniche:sco:p73
children	p73:PrimaRataAccontolrpef p73:SecondaRataAccontolrpef p73:AccontoAddComunale p73:PrimaRataAccontoCedolare p73:SecondaRataAccontoCedolare

element Acconti_Irpef_Anno_Imposta_Type/PrimaRataAccontolrpef

diagram					
namespace	urn:www.agenziaentrate.gov.it:specificheTecniche:sco:p73				
type	DatoNP_Type				
facets	<table border="1"> <tr> <td>Kind</td> <td>Value</td> </tr> <tr> <td>pattern</td> <td>[1-9]{1}[0-9]*</td> </tr> </table>	Kind	Value	pattern	[1-9]{1}[0-9]*
Kind	Value				
pattern	[1-9]{1}[0-9]*				

element Acconti_Irpef_Anno_Imposta_Type/SecondaRataAccontolrpef

diagram					
namespace	urn:www.agenziaentrate.gov.it:specificheTecniche:sco:p73				
type	DatoNP_Type				
facets	<table border="1"> <tr> <td>Kind</td> <td>Value</td> </tr> <tr> <td>pattern</td> <td>[1-9]{1}[0-9]*</td> </tr> </table>	Kind	Value	pattern	[1-9]{1}[0-9]*
Kind	Value				
pattern	[1-9]{1}[0-9]*				

element Acconti_Irpef_Anno_Imposta_Type/AccontoAddComunale

diagram					
namespace	urn:www.agenziaentrate.gov.it:specificheTecniche:sco:p73				
type	DatoNP_Type				
facets	<table border="1"> <tr> <td>Kind</td> <td>Value</td> </tr> <tr> <td>pattern</td> <td>[1-9]{1}[0-9]*</td> </tr> </table>	Kind	Value	pattern	[1-9]{1}[0-9]*
Kind	Value				
pattern	[1-9]{1}[0-9]*				

element **Acconti_Irpef_Anno_Imposta_Type/PrimaRataAccontoCedolare**

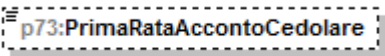
diagram					
namespace	urn:www.agenziaentrate.gov.it:specificheTecniche:sco:p73				
type	DatoNP_Type				
facets	<table border="1"> <tr> <td>Kind</td> <td>Value</td> </tr> <tr> <td>pattern</td> <td>[1-9]{1}[0-9]*</td> </tr> </table>	Kind	Value	pattern	[1-9]{1}[0-9]*
Kind	Value				
pattern	[1-9]{1}[0-9]*				

element **Acconti_Irpef_Anno_Imposta_Type/SecondaRataAccontoCedolare**

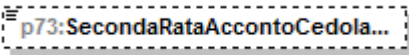
diagram					
namespace	urn:www.agenziaentrate.gov.it:specificheTecniche:sco:p73				
type	DatoNP_Type				
facets	<table border="1"> <tr> <td>Kind</td> <td>Value</td> </tr> <tr> <td>pattern</td> <td>[1-9]{1}[0-9]*</td> </tr> </table>	Kind	Value	pattern	[1-9]{1}[0-9]*
Kind	Value				
pattern	[1-9]{1}[0-9]*				

complexType **Acconti_Ritenute_Type**

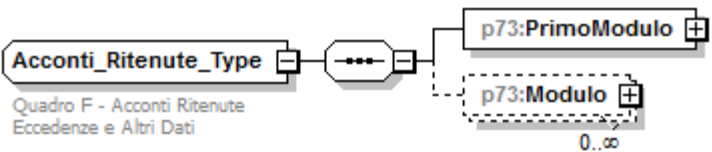
diagram	 <p>Acconti_Ritenute_Type Quadro F - Acconti Ritenute Eccedenze e Altri Dati</p> <p>p73:PrimoModulo p73:Modulo 0..∞</p>
namespace	urn:www.agenziaentrate.gov.it:specificheTecniche:sco:p73
children	p73:PrimoModulo p73:Modulo

element **Acconti_Ritenute_Type/PrimoModulo**

<p>diagram</p>	
<p>namespace</p>	<p>urn:www.agenziaentrate.gov.it:specificheTecniche:sco:p73</p>
<p>type</p>	<p>p73:Primo_Modulo_Acconti_Ritenute_Type</p>
<p>children</p>	<p>p73:Accontilrpef p73:AltreRitenute p73:Eccedenze p73:EccedenzeOltreAnno p73:RitenuteAccontiSospesi p73:MisuraAcconti p73:EsenzioneAddComunale p73:Dati730Integrativo p73:AccontiAltriDati</p>

element **Acconti_Ritenute_Type/Modulo**

<p>diagram</p>	
<p>namespace</p>	<p>urn:www.agenziaentrate.gov.it:specificheTecniche:sco:p73</p>
<p>children</p>	<p>p73:AltreRitenute p73:Pignoramento</p>

element **Acconti_Ritenute_Type/Modulo/AltreRitenute**

diagram	
namespace	urn:www.agenziaentrate.gov.it:specificheTecniche:sco:p73
type	p73:Altre Ritenute Type
children	p73:Codice p73:AltreRitenuteIrpef p73:AddizionaleRegionale p73:AddizionaleComunale p73:AddRegionaleIrpefAttivitaSport p73:AddComunaleIrpefAttivitaSport p73:IrpefLavoriSocialmenteUttili p73:AddRegionaleIrpefLavoriSoc Utili

element **Acconti_Ritenute_Type/Modulo/Pignoramento**

diagram	
namespace	urn:www.agenziaentrate.gov.it:specificheTecniche:sco:p73
children	p73:TipoRedditoPignoramento p73:RitenutePignoramento

element **Acconti_Ritenute_Type/Modulo/Pignoramento/TipoRedditoPignoramento**

diagram																	
namespace	urn:www.agenziaentrate.gov.it:specificheTecniche:sco:p73																
type	restriction of DatoN1_Type																
facets	<table border="1"> <thead> <tr> <th>Kind</th> <th>Value</th> </tr> </thead> <tbody> <tr> <td>pattern</td> <td>[1-9]</td> </tr> <tr> <td>enumeration</td> <td>1</td> </tr> <tr> <td>enumeration</td> <td>2</td> </tr> <tr> <td>enumeration</td> <td>3</td> </tr> <tr> <td>enumeration</td> <td>4</td> </tr> <tr> <td>enumeration</td> <td>5</td> </tr> <tr> <td>enumeration</td> <td>6</td> </tr> </tbody> </table>	Kind	Value	pattern	[1-9]	enumeration	1	enumeration	2	enumeration	3	enumeration	4	enumeration	5	enumeration	6
Kind	Value																
pattern	[1-9]																
enumeration	1																
enumeration	2																
enumeration	3																
enumeration	4																
enumeration	5																
enumeration	6																

element Acconti_Ritenute_Type/Modulo/Pignoramento/RitenutePignoramento

diagram	
namespace	urn:www.agenziaentrate.gov.it:specificheTecniche:sco:p73
type	DatoNP_Type
facets	Kind Value pattern [1-9]{1}[0-9]*

complexType Acoonti_Compensati_Intern_Type

diagram	
namespace	urn:www.agenziaentrate.gov.it:specificheTecniche:sco:p73
children	p73:PrimaRatalrpef p73:AddizionaleComunale p73:PrimaRataCedolare

element Acoonti_Compensati_Intern_Type/PrimaRatalrpef

diagram	
namespace	urn:www.agenziaentrate.gov.it:specificheTecniche:sco:p73
type	DatoNP_Type
facets	Kind Value pattern [1-9]{1}[0-9]*

element Acoonti_Compensati_Intern_Type/AddizionaleComunale

diagram	
namespace	urn:www.agenziaentrate.gov.it:specificheTecniche:sco:p73
type	DatoNP_Type
facets	Kind Value pattern [1-9]{1}[0-9]*

element Acoonti_Compensati_Intern_Type/PrimaRataCedolare

diagram	
namespace	urn:www.agenziaentrate.gov.it:specificheTecniche:sco:p73

type	DatoNP_Type
facets	Kind Value pattern [1-9]{1}[0-9]*

complexType **Acquisto_Costruzione_Abit_Locazione**

diagram	
namespace	urn:www.agenziaentrate.gov.it:specificheTecniche:sco:p73
children	p73:DataStipula p73:Spesa p73:InteressiMutuo

element **Acquisto_Costruzione_Abit_Locazione/DataStipula**

diagram	
namespace	urn:www.agenziaentrate.gov.it:specificheTecniche:sco:p73
type	DatoDT_Type
facets	Kind Value pattern (((([1-9][12][0-9]3[01])(0[13578]10 12)\d{4})) ((([0][1-9][12][0-9]30)(0[469]11)\d{4})) ((([0][1-9]1[0-9]2[0-8])(02)\d{4})) ((29)(02)([02468][048]00)) ((29)(02)([13579][26]00)) ((29)(02)([0-9][0-9][0]48)) ((29)(02)([0-9][0-9][2468][048])) ((29)(02)([0-9][0-9][13579][26]))))

element **Acquisto_Costruzione_Abit_Locazione/Spesa**

diagram	
namespace	urn:www.agenziaentrate.gov.it:specificheTecniche:sco:p73
type	DatoNP_Type
facets	Kind Value pattern [1-9]{1}[0-9]*

element **Acquisto_Costruzione_Abit_Locazione/InteressiMutuo**

diagram	
namespace	urn:www.agenziaentrate.gov.it:specificheTecniche:sco:p73
type	DatoNP_Type
facets	Kind Value pattern [1-9]{1}[0-9]*

complexType **Addizionali_Type**

diagram	
namespace	urn:www.agenziaentrate.gov.it:specificheTecniche:sco:p73
children	p73:Imponibile p73:AddRegDovuta p73:AddRegCertif p73:EccedenzaAddReg p73:AddComDovuta p73:AddComCertif p73:EccedenzaAddCom p73:AccontoAddCom p73:AccontoAddComCertif

element **Addizionali_Type/Imponibile**

diagram					
namespace	urn:www.agenziaentrate.gov.it:specificheTecniche:sco:p73				
type	DatoNP_Type				
facets	<table border="1"> <tr> <td>Kind</td> <td>Value</td> </tr> <tr> <td>pattern</td> <td>[1-9]{1}[0-9]*</td> </tr> </table>	Kind	Value	pattern	[1-9]{1}[0-9]*
Kind	Value				
pattern	[1-9]{1}[0-9]*				

element **Addizionali_Type/AddRegDovuta**

diagram					
namespace	urn:www.agenziaentrate.gov.it:specificheTecniche:sco:p73				
type	DatoNP_Type				
facets	<table border="1"> <tr> <td>Kind</td> <td>Value</td> </tr> <tr> <td>pattern</td> <td>[1-9]{1}[0-9]*</td> </tr> </table>	Kind	Value	pattern	[1-9]{1}[0-9]*
Kind	Value				
pattern	[1-9]{1}[0-9]*				

element **Addizionali_Type/AddRegCertif**

diagram	
namespace	urn:www.agenziaentrate.gov.it:specificheTecniche:sco:p73

type	DatoNP_Type
facets	Kind Value pattern [1-9]{1}[0-9]*

element `Additionali_Type/EccedenzaAddReg`

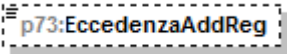
diagram	
namespace	urn:www.agenziaentrate.gov.it:specificheTecniche:sco:p73
type	DatoNU_Type
facets	Kind Value pattern (\-[1-9] [1-9])[0-9]*

element `Additionali_Type/AddComDovuta`

diagram	
namespace	urn:www.agenziaentrate.gov.it:specificheTecniche:sco:p73
type	DatoNP_Type
facets	Kind Value pattern [1-9]{1}[0-9]*

element `Additionali_Type/AddComCertif`

diagram	
namespace	urn:www.agenziaentrate.gov.it:specificheTecniche:sco:p73
type	DatoNP_Type
facets	Kind Value pattern [1-9]{1}[0-9]*

element `Additionali_Type/EccedenzaAddCom`

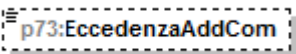
diagram	
namespace	urn:www.agenziaentrate.gov.it:specificheTecniche:sco:p73
type	DatoNU_Type
facets	Kind Value pattern (\-[1-9] [1-9])[0-9]*

element `Additionali_Type/AcontoAddCom`

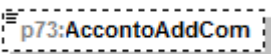
diagram	
namespace	urn:www.agenziaentrate.gov.it:specificheTecniche:sco:p73

type	DatoNP_Type
facets	Kind Value pattern [1-9]{1}[0-9]*

element **Additionali_Type/AcontoAddComCertif**

diagram	
namespace	urn:www.agenziaentrate.gov.it:specificheTecniche:sco:p73
type	DatoNP_Type
facets	Kind Value pattern [1-9]{1}[0-9]*

complexType **Altre_Detrazioni_Type**

diagram	
namespace	urn:www.agenziaentrate.gov.it:specificheTecniche:sco:p73
children	p73:Codice p73:Importo

element **Altre_Detrazioni_Type/Codice**

diagram	
namespace	urn:www.agenziaentrate.gov.it:specificheTecniche:sco:p73
type	p73:Codice Altre_Detrazioni_Type
facets	Kind Value pattern [1-9]{1}[0-9]* enumeration 1 enumeration 2

element **Altre_Detrazioni_Type/Importo**

diagram	
namespace	urn:www.agenziaentrate.gov.it:specificheTecniche:sco:p73
type	DatoNP_Type
facets	Kind Value pattern [1-9]{1}[0-9]*

complexType **Altre_Ritenute_Type**

diagram	
namespace	urn:www.agenziaentrate.gov.it:specificheTecniche:sco:p73
children	p73:Codice p73:AltreRitenuteIrpef p73:AddizionaleRegionale p73:AddizionaleComunale p73:AddRegionaleIrpefAttivitaSport p73:AddComunaleIrpefAttivitaSport p73:IrpefLavoriSocialmenteUtili p73:AddRegionaleIrpefLavoriSoc Utili

element **Altre_Ritenute_Type/Codice**

diagram									
namespace	urn:www.agenziaentrate.gov.it:specificheTecniche:sco:p73								
type	restriction of DatoN1_Type								
facets	<table border="1"> <thead> <tr> <th>Kind</th> <th>Value</th> </tr> </thead> <tbody> <tr> <td>pattern</td> <td>[1-9]</td> </tr> <tr> <td>enumeration</td> <td>1</td> </tr> <tr> <td>enumeration</td> <td>2</td> </tr> </tbody> </table>	Kind	Value	pattern	[1-9]	enumeration	1	enumeration	2
Kind	Value								
pattern	[1-9]								
enumeration	1								
enumeration	2								

element **Altre_Ritenute_Type/AltreRitenuteIrpef**

diagram					
namespace	urn:www.agenziaentrate.gov.it:specificheTecniche:sco:p73				
type	DatoNP_Type				
facets	<table border="1"> <thead> <tr> <th>Kind</th> <th>Value</th> </tr> </thead> <tbody> <tr> <td>pattern</td> <td>[1-9]{1}[0-9]*</td> </tr> </tbody> </table>	Kind	Value	pattern	[1-9]{1}[0-9]*
Kind	Value				
pattern	[1-9]{1}[0-9]*				

element **Altre_Ritenute_Type/AddizionaleRegionale**

diagram	
namespace	urn:www.agenziaentrate.gov.it:specificheTecniche:sco:p73

type	DatoNP_Type
facets	Kind Value pattern [1-9]{1}[0-9]*

element Altre_Ritenute_Type/AddizionaleComunale

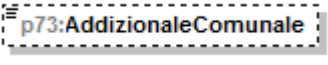
diagram	
namespace	urn:www.agenziaentrate.gov.it:specificheTecniche:sco:p73
type	DatoNP_Type
facets	Kind Value pattern [1-9]{1}[0-9]*

element Altre_Ritenute_Type/AddRegionalelrpefAttivitaSport

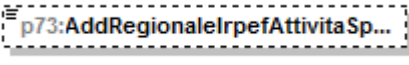
diagram	
namespace	urn:www.agenziaentrate.gov.it:specificheTecniche:sco:p73
type	DatoNP_Type
facets	Kind Value pattern [1-9]{1}[0-9]*

element Altre_Ritenute_Type/AddComunalelrpefAttivitaSport

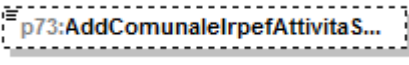
diagram	
namespace	urn:www.agenziaentrate.gov.it:specificheTecniche:sco:p73
type	DatoNP_Type
facets	Kind Value pattern [1-9]{1}[0-9]*

element Altre_Ritenute_Type/lrpefLavoriSocialmenteUtili

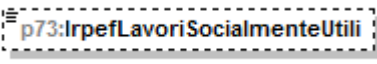
diagram	
namespace	urn:www.agenziaentrate.gov.it:specificheTecniche:sco:p73
type	DatoNP_Type
facets	Kind Value pattern [1-9]{1}[0-9]*

element Altre_Ritenute_Type/AddRegionalelrpefLavoriSoc_Utili

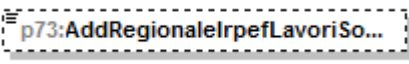
diagram	
namespace	urn:www.agenziaentrate.gov.it:specificheTecniche:sco:p73

type	DatoNP_Type				
facets	<table border="1"> <thead> <tr> <th>Kind</th> <th>Value</th> </tr> </thead> <tbody> <tr> <td>pattern</td> <td>[1-9]{1}[0-9]*</td> </tr> </tbody> </table>	Kind	Value	pattern	[1-9]{1}[0-9]*
Kind	Value				
pattern	[1-9]{1}[0-9]*				

complexType **Altre_Spese_Type**

diagram	<p>The diagram shows a class named 'Altre_Spese_Type' with a dashed-line box around it. Inside this class, there are two elements: 'p73:Codice' and 'p73:Importo', both also enclosed in dashed-line boxes. This indicates that these elements are part of the complex type's structure.</p>
namespace	urn:www.agenziaentrate.gov.it:specificheTecniche:sco:p73
children	p73:Codice p73:Importo

element **Altre_Spese_Type/Codice**

diagram	<p>The diagram shows a single element named 'p73:Codice' enclosed in a dashed-line box, representing its structure as a simple type.</p>																																																																				
namespace	urn:www.agenziaentrate.gov.it:specificheTecniche:sco:p73																																																																				
type	p73:Codice Altre_Spese_Type																																																																				
facets	<table border="1"> <thead> <tr> <th>Kind</th> <th>Value</th> </tr> </thead> <tbody> <tr> <td>pattern</td> <td>[1-9]{1}[0-9]*</td> </tr> <tr><td>enumeration</td><td>8</td></tr> <tr><td>enumeration</td><td>9</td></tr> <tr><td>enumeration</td><td>10</td></tr> <tr><td>enumeration</td><td>11</td></tr> <tr><td>enumeration</td><td>12</td></tr> <tr><td>enumeration</td><td>13</td></tr> <tr><td>enumeration</td><td>14</td></tr> <tr><td>enumeration</td><td>15</td></tr> <tr><td>enumeration</td><td>16</td></tr> <tr><td>enumeration</td><td>17</td></tr> <tr><td>enumeration</td><td>18</td></tr> <tr><td>enumeration</td><td>20</td></tr> <tr><td>enumeration</td><td>21</td></tr> <tr><td>enumeration</td><td>22</td></tr> <tr><td>enumeration</td><td>23</td></tr> <tr><td>enumeration</td><td>24</td></tr> <tr><td>enumeration</td><td>25</td></tr> <tr><td>enumeration</td><td>26</td></tr> <tr><td>enumeration</td><td>27</td></tr> <tr><td>enumeration</td><td>28</td></tr> <tr><td>enumeration</td><td>29</td></tr> <tr><td>enumeration</td><td>30</td></tr> <tr><td>enumeration</td><td>31</td></tr> <tr><td>enumeration</td><td>32</td></tr> <tr><td>enumeration</td><td>33</td></tr> <tr><td>enumeration</td><td>35</td></tr> <tr><td>enumeration</td><td>36</td></tr> <tr><td>enumeration</td><td>38</td></tr> <tr><td>enumeration</td><td>39</td></tr> <tr><td>enumeration</td><td>41</td></tr> <tr><td>enumeration</td><td>42</td></tr> <tr><td>enumeration</td><td>99</td></tr> </tbody> </table>	Kind	Value	pattern	[1-9]{1}[0-9]*	enumeration	8	enumeration	9	enumeration	10	enumeration	11	enumeration	12	enumeration	13	enumeration	14	enumeration	15	enumeration	16	enumeration	17	enumeration	18	enumeration	20	enumeration	21	enumeration	22	enumeration	23	enumeration	24	enumeration	25	enumeration	26	enumeration	27	enumeration	28	enumeration	29	enumeration	30	enumeration	31	enumeration	32	enumeration	33	enumeration	35	enumeration	36	enumeration	38	enumeration	39	enumeration	41	enumeration	42	enumeration	99
Kind	Value																																																																				
pattern	[1-9]{1}[0-9]*																																																																				
enumeration	8																																																																				
enumeration	9																																																																				
enumeration	10																																																																				
enumeration	11																																																																				
enumeration	12																																																																				
enumeration	13																																																																				
enumeration	14																																																																				
enumeration	15																																																																				
enumeration	16																																																																				
enumeration	17																																																																				
enumeration	18																																																																				
enumeration	20																																																																				
enumeration	21																																																																				
enumeration	22																																																																				
enumeration	23																																																																				
enumeration	24																																																																				
enumeration	25																																																																				
enumeration	26																																																																				
enumeration	27																																																																				
enumeration	28																																																																				
enumeration	29																																																																				
enumeration	30																																																																				
enumeration	31																																																																				
enumeration	32																																																																				
enumeration	33																																																																				
enumeration	35																																																																				
enumeration	36																																																																				
enumeration	38																																																																				
enumeration	39																																																																				
enumeration	41																																																																				
enumeration	42																																																																				
enumeration	99																																																																				

element **Altre_Spese_Type/Importo**

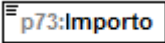
diagram	
namespace	urn:www.agenziaentrate.gov.it:specificheTecniche:sco:p73
type	DatoNP_Type
facets	Kind Value pattern [1-9]{1}[0-9]*

complexType **Altri_Dati_Type**

diagram	
namespace	urn:www.agenziaentrate.gov.it:specificheTecniche:sco:p73
children	p73:ResiduoCreditoErogazioneCultura p73:ResiduoCreditoPrimaCasa p73:ResiduoCreditoOccupazione p73:ResiduoCreditoSisma p73:ResiduoCreditoFondiPensione p73:ResiduoCreditoMediazioni

	p73:TotSpeseSanitarieRateizzate p73:RedditoAgevolazioniFiscali p73:RedditoComplessivoAcconto p73:RigoDifferenzaAcconto p73:AccontiCompensatiIntern p73:RedditiFondariNonImponibili p73:RedditoAbitazionePrincipalePertinenze p73:ResiduoDeduzioneSommeRestituite p73:ResiduoErogazioniScuola p73:ResiduoCreditoNegoziazione p73:ResiduoCreditoVideosorveglianza p73:CreditoErogazioneCultura
--	--

element Altri_Dati_Type/ResiduoCreditoErogazioneCultura

diagram					
namespace	urn:www.agenziaentrate.gov.it:specificheTecniche:sco:p73				
type	DatoNP_Type				
facets	<table border="1"> <tr> <th>Kind</th> <th>Value</th> </tr> <tr> <td>pattern</td> <td>[1-9]{1}[0-9]*</td> </tr> </table>	Kind	Value	pattern	[1-9]{1}[0-9]*
Kind	Value				
pattern	[1-9]{1}[0-9]*				

element Altri_Dati_Type/ResiduoCreditoPrimaCasa

diagram					
namespace	urn:www.agenziaentrate.gov.it:specificheTecniche:sco:p73				
type	DatoNP_Type				
facets	<table border="1"> <tr> <th>Kind</th> <th>Value</th> </tr> <tr> <td>pattern</td> <td>[1-9]{1}[0-9]*</td> </tr> </table>	Kind	Value	pattern	[1-9]{1}[0-9]*
Kind	Value				
pattern	[1-9]{1}[0-9]*				

element Altri_Dati_Type/ResiduoCreditoOccupazione

diagram					
namespace	urn:www.agenziaentrate.gov.it:specificheTecniche:sco:p73				
type	DatoNP_Type				
facets	<table border="1"> <tr> <th>Kind</th> <th>Value</th> </tr> <tr> <td>pattern</td> <td>[1-9]{1}[0-9]*</td> </tr> </table>	Kind	Value	pattern	[1-9]{1}[0-9]*
Kind	Value				
pattern	[1-9]{1}[0-9]*				

element Altri_Dati_Type/ResiduoCreditoSisma

diagram					
namespace	urn:www.agenziaentrate.gov.it:specificheTecniche:sco:p73				
type	DatoNP_Type				
facets	<table border="1"> <tr> <th>Kind</th> <th>Value</th> </tr> <tr> <td>pattern</td> <td>[1-9]{1}[0-9]*</td> </tr> </table>	Kind	Value	pattern	[1-9]{1}[0-9]*
Kind	Value				
pattern	[1-9]{1}[0-9]*				

element Altri_Dati_Type/ResiduoCreditoFondiPensione

diagram	
---------	--

namespace	urn:www.agenziaentrate.gov.it:specificheTecniche:sco:p73
type	DatoNP_Type
facets	Kind Value pattern [1-9]{1}[0-9]*

element Altri_Dati_Type/ResiduoCreditoMediazioni

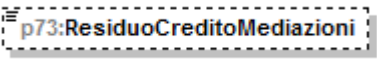
diagram	
namespace	urn:www.agenziaentrate.gov.it:specificheTecniche:sco:p73
type	DatoNP_Type
facets	Kind Value pattern [1-9]{1}[0-9]*

element Altri_Dati_Type/TotSpeseSanitarieRateizzate

diagram	
namespace	urn:www.agenziaentrate.gov.it:specificheTecniche:sco:p73
type	DatoNP_Type
facets	Kind Value pattern [1-9]{1}[0-9]*

element Altri_Dati_Type/RedditoAgevolazioniFiscali

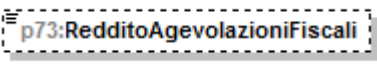
diagram	
namespace	urn:www.agenziaentrate.gov.it:specificheTecniche:sco:p73
type	DatoNP_Type
facets	Kind Value pattern [1-9]{1}[0-9]*

element Altri_Dati_Type/RedditoComplessivoAcconto

diagram	
namespace	urn:www.agenziaentrate.gov.it:specificheTecniche:sco:p73
type	DatoNP_Type
facets	Kind Value pattern [1-9]{1}[0-9]*

element Altri_Dati_Type/RigoDifferenzaAcconto

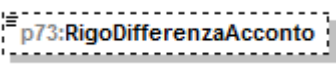
diagram	
---------	---

namespace	urn:www.agenziaentrate.gov.it:specificheTecniche:sco:p73
type	DatoNU_Type
facets	Kind Value pattern $(\-[1-9] [1-9])[0-9]^*$

element **Altri_Dati_Type/AccontiCompensatiIntern**

diagram	
namespace	urn:www.agenziaentrate.gov.it:specificheTecniche:sco:p73
type	p73:Acoonti_Compensati_Intern_Type
children	p73:PrimaRataIrpef p73:AddizionaleComunale p73:PrimaRataCedolare

element **Altri_Dati_Type/RedditiFondariNonImponibili**

diagram	
namespace	urn:www.agenziaentrate.gov.it:specificheTecniche:sco:p73
type	DatoNP_Type
facets	Kind Value pattern $[1-9]\{1\}[0-9]^*$

element **Altri_Dati_Type/RedditoAbitazionePrincipalePertinenze**

diagram	
namespace	urn:www.agenziaentrate.gov.it:specificheTecniche:sco:p73
type	DatoNP_Type
facets	Kind Value pattern $[1-9]\{1\}[0-9]^*$

element **Altri_Dati_Type/ResiduoDeduzioneSommeRestituite**

diagram	
namespace	urn:www.agenziaentrate.gov.it:specificheTecniche:sco:p73
type	DatoNP_Type

facets	Kind pattern	Value [1-9]{1}[0-9]*
--------	-----------------	-------------------------

element Altri_Dati_Type/ResiduoErogazioniScuola

diagram		
namespace	urn:www.agenziaentrate.gov.it:specificheTecniche:sco:p73	
type	DatoNP_Type	
facets	Kind pattern	Value [1-9]{1}[0-9]*

element Altri_Dati_Type/ResiduoCreditoNegoziazione

diagram		
namespace	urn:www.agenziaentrate.gov.it:specificheTecniche:sco:p73	
type	DatoNP_Type	
facets	Kind pattern	Value [1-9]{1}[0-9]*

element Altri_Dati_Type/ResiduoCreditoVideosorveglianza

diagram		
namespace	urn:www.agenziaentrate.gov.it:specificheTecniche:sco:p73	
type	DatoNP_Type	
facets	Kind pattern	Value [1-9]{1}[0-9]*

element Altri_Dati_Type/CreditoErogazioneCultura

diagram		
namespace	urn:www.agenziaentrate.gov.it:specificheTecniche:sco:p73	
type	p73:Cred_Erogazione_Cultura_Type	
children	p73:RataAnnoPrec p73:RataAnno	

complexType Altri_Oneri_Type

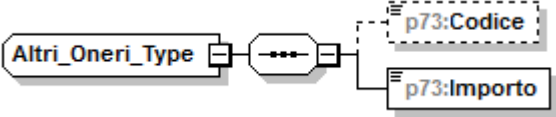
diagram	
namespace	urn:www.agenziaentrate.gov.it:specificheTecniche:sco:p73
children	p73:Codice p73:Importo

element Altri_Oneri_Type/Codice

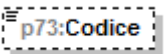
diagram																			
namespace	urn:www.agenziaentrate.gov.it:specificheTecniche:sco:p73																		
type	p73:Codice Altri_Oneri_Type																		
facets	<table border="1"> <thead> <tr> <th>Kind</th> <th>Value</th> </tr> </thead> <tbody> <tr> <td>pattern</td> <td>[1-9]{1}[0-9]*</td> </tr> <tr> <td>enumeration</td> <td>6</td> </tr> <tr> <td>enumeration</td> <td>7</td> </tr> <tr> <td>enumeration</td> <td>8</td> </tr> <tr> <td>enumeration</td> <td>9</td> </tr> <tr> <td>enumeration</td> <td>12</td> </tr> <tr> <td>enumeration</td> <td>13</td> </tr> <tr> <td>enumeration</td> <td>21</td> </tr> </tbody> </table>	Kind	Value	pattern	[1-9]{1}[0-9]*	enumeration	6	enumeration	7	enumeration	8	enumeration	9	enumeration	12	enumeration	13	enumeration	21
Kind	Value																		
pattern	[1-9]{1}[0-9]*																		
enumeration	6																		
enumeration	7																		
enumeration	8																		
enumeration	9																		
enumeration	12																		
enumeration	13																		
enumeration	21																		

element Altri_Oneri_Type/Importo

diagram					
namespace	urn:www.agenziaentrate.gov.it:specificheTecniche:sco:p73				
type	DatoNP_Type				
facets	<table border="1"> <thead> <tr> <th>Kind</th> <th>Value</th> </tr> </thead> <tbody> <tr> <td>pattern</td> <td>[1-9]{1}[0-9]*</td> </tr> </tbody> </table>	Kind	Value	pattern	[1-9]{1}[0-9]*
Kind	Value				
pattern	[1-9]{1}[0-9]*				

complexType Altri_Reddito_Ass_Lav_Type

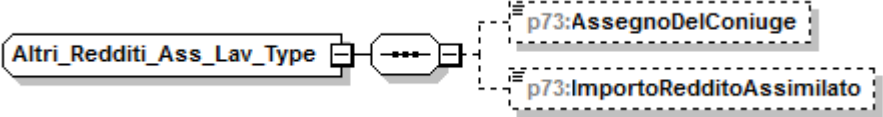
diagram	
namespace	urn:www.agenziaentrate.gov.it:specificheTecniche:sco:p73
children	p73:AssegnoDelConiuge p73:ImportoRedditoAssimilato

element Altri_Reddito_Ass_Lav_Type/AssegnoDelConiuge

diagram	
---------	---

namespace	urn:www.agenziaentrate.gov.it:specificheTecniche:sco:p73
type	DatoCB_Type
facets	Kind Value pattern [01]

element **Altri_Reddito_Ass_Lav_Type/ImportoRedditoAssimilato**

diagram	
namespace	urn:www.agenziaentrate.gov.it:specificheTecniche:sco:p73
type	DatoNP_Type
facets	Kind Value pattern [1-9]{1}[0-9]*

complexType **Altri_Reddito_Diversi_Detr_Type**

diagram	
namespace	urn:www.agenziaentrate.gov.it:specificheTecniche:sco:p73
children	p73:Tipo_Reddito p73:RedditiRitenuteSpese

element **Altri_Reddito_Diversi_Detr_Type/Tipo_Reddito**

diagram	
namespace	urn:www.agenziaentrate.gov.it:specificheTecniche:sco:p73
type	p73:Tipo_Reddito_Da1a4_Type
facets	Kind Value pattern [1-9] enumeration 1 enumeration 2 enumeration 3 enumeration 4

element **Altri_Reddito_Diversi_Detr_Type/RedditiRitenuteSpese**

diagram	
---------	--

namespace	urn:www.agenziaentrate.gov.it:specificheTecniche:sco:p73
type	p73:Redditi Ritenute Spese Type
children	p73:ImportoRedditi p73:ImportoRitenute p73:ImportoSpese

complexType Altri_Redditi_Diversi_Type

diagram	
namespace	urn:www.agenziaentrate.gov.it:specificheTecniche:sco:p73
children	p73:TipoReddito p73:RedditiRitenuteSpese

element Altri_Redditi_Diversi_Type/TipoReddito

diagram																							
namespace	urn:www.agenziaentrate.gov.it:specificheTecniche:sco:p73																						
type	p73:Tipo Reddito Da1a9 Type																						
facets	<table border="1"> <thead> <tr> <th>Kind</th> <th>Value</th> </tr> </thead> <tbody> <tr> <td>pattern</td> <td>[1-9]{1}[0-9]*</td> </tr> <tr> <td>enumeration</td> <td>1</td> </tr> <tr> <td>enumeration</td> <td>2</td> </tr> <tr> <td>enumeration</td> <td>3</td> </tr> <tr> <td>enumeration</td> <td>4</td> </tr> <tr> <td>enumeration</td> <td>5</td> </tr> <tr> <td>enumeration</td> <td>6</td> </tr> <tr> <td>enumeration</td> <td>7</td> </tr> <tr> <td>enumeration</td> <td>8</td> </tr> <tr> <td>enumeration</td> <td>9</td> </tr> </tbody> </table>	Kind	Value	pattern	[1-9]{1}[0-9]*	enumeration	1	enumeration	2	enumeration	3	enumeration	4	enumeration	5	enumeration	6	enumeration	7	enumeration	8	enumeration	9
Kind	Value																						
pattern	[1-9]{1}[0-9]*																						
enumeration	1																						
enumeration	2																						
enumeration	3																						
enumeration	4																						
enumeration	5																						
enumeration	6																						
enumeration	7																						
enumeration	8																						
enumeration	9																						

element Altri_Redditi_Diversi_Type/RedditiRitenuteSpese

diagram	
namespace	urn:www.agenziaentrate.gov.it:specificheTecniche:sco:p73
type	p73:Redditi Ritenute Spese Type
children	p73:ImportoRedditi p73:ImportoRitenute p73:ImportoSpese

complexType Altri_Reddito_Lavoro_Autonomo_Type

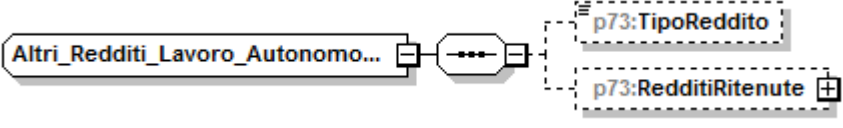
diagram	
namespace	urn:www.agenziaentrate.gov.it:specificheTecniche:sco:p73
children	p73:TipoReddito p73:RedditiRitenute

element Altri_Reddito_Lavoro_Autonomo_Type/TipoReddito

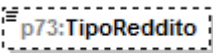
diagram											
namespace	urn:www.agenziaentrate.gov.it:specificheTecniche:sco:p73										
type	p73:Tipo_Reddito_Da1a3_Type										
facets	<table border="1"> <thead> <tr> <th>Kind</th> <th>Value</th> </tr> </thead> <tbody> <tr> <td>pattern</td> <td>[1-9]</td> </tr> <tr> <td>enumeration</td> <td>1</td> </tr> <tr> <td>enumeration</td> <td>2</td> </tr> <tr> <td>enumeration</td> <td>3</td> </tr> </tbody> </table>	Kind	Value	pattern	[1-9]	enumeration	1	enumeration	2	enumeration	3
Kind	Value										
pattern	[1-9]										
enumeration	1										
enumeration	2										
enumeration	3										

element Altri_Reddito_Lavoro_Autonomo_Type/RedditiRitenute

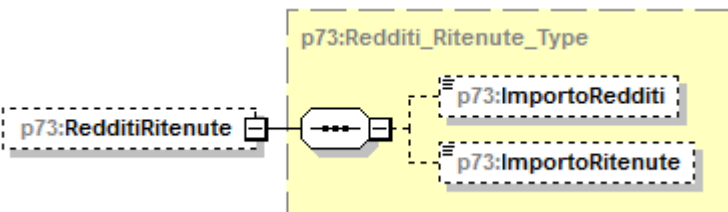
diagram	
namespace	urn:www.agenziaentrate.gov.it:specificheTecniche:sco:p73
type	p73:Redditi_Ritenute_Type
children	p73:ImportoRedditi p73:ImportoRitenute

complexType Altri_Reddito_Type

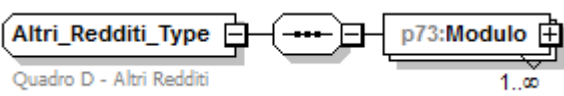
diagram	
namespace	urn:www.agenziaentrate.gov.it:specificheTecniche:sco:p73
children	p73:Modulo

element **Altri_Reddito_Type/Modulo**

diagram	
namespace	urn:www.agenziaentrate.gov.it:specificheTecniche:sco:p73
type	p73:Modulo_Altri_Reddito_Type
children	p73:RedditiDiCapitale p73:RedditiTassazioneSeparata

complexType **Altri_Reddito_Utili_Type**

diagram	
namespace	urn:www.agenziaentrate.gov.it:specificheTecniche:sco:p73
children	p73:Tipo_Reddito p73:RedditiRitenute

element **Altri_Reddito_Utili_Type/Tipo_Reddito**

diagram																					
namespace	urn:www.agenziaentrate.gov.it:specificheTecniche:sco:p73																				
type	p73:Tipo_Reddito_Da1a8_Type																				
facets	<table border="1"> <thead> <tr> <th>Kind</th> <th>Value</th> </tr> </thead> <tbody> <tr> <td>pattern</td> <td>[1-9]{1}[0-9]*</td> </tr> <tr> <td>enumeration</td> <td>1</td> </tr> <tr> <td>enumeration</td> <td>2</td> </tr> <tr> <td>enumeration</td> <td>3</td> </tr> <tr> <td>enumeration</td> <td>4</td> </tr> <tr> <td>enumeration</td> <td>5</td> </tr> <tr> <td>enumeration</td> <td>6</td> </tr> <tr> <td>enumeration</td> <td>7</td> </tr> <tr> <td>enumeration</td> <td>8</td> </tr> </tbody> </table>	Kind	Value	pattern	[1-9]{1}[0-9]*	enumeration	1	enumeration	2	enumeration	3	enumeration	4	enumeration	5	enumeration	6	enumeration	7	enumeration	8
Kind	Value																				
pattern	[1-9]{1}[0-9]*																				
enumeration	1																				
enumeration	2																				
enumeration	3																				
enumeration	4																				
enumeration	5																				
enumeration	6																				
enumeration	7																				
enumeration	8																				

element **Altri_Reddito_Utili_Type/RedditiRitenute**

diagram	
namespace	urn:www.agenziaentrate.gov.it:specificheTecniche:sco:p73

type	p73:Redditi Ritenute Type
children	p73:ImportoRedditi p73:ImportoRitenute

complexType **Assegno_Coniuge_Type**

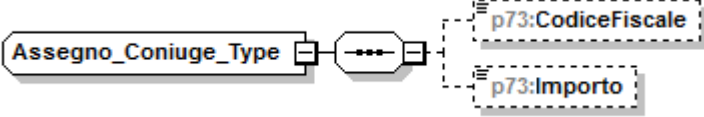
diagram	
namespace	urn:www.agenziaentrate.gov.it:specificheTecniche:sco:p73
children	p73:CodiceFiscale p73:Importo

element **Assegno_Coniuge_Type/CodiceFiscale**

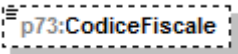
diagram					
namespace	urn:www.agenziaentrate.gov.it:specificheTecniche:sco:p73				
type	DatoCF_Type				
facets	<table border="1"> <thead> <tr> <th>Kind</th> <th>Value</th> </tr> </thead> <tbody> <tr> <td>pattern</td> <td>[0-9]{11}[A-Z]{6}[0-9LMNPQRSTUUV]{2}[A-Z]{1}[0-9LMNPQRSTUUV]{2}[A-Z]{1}[0-9LMNPQRSTUUV]{3}[A-Z]{1}</td> </tr> </tbody> </table>	Kind	Value	pattern	[0-9]{11}[A-Z]{6}[0-9LMNPQRSTUUV]{2}[A-Z]{1}[0-9LMNPQRSTUUV]{2}[A-Z]{1}[0-9LMNPQRSTUUV]{3}[A-Z]{1}
Kind	Value				
pattern	[0-9]{11}[A-Z]{6}[0-9LMNPQRSTUUV]{2}[A-Z]{1}[0-9LMNPQRSTUUV]{2}[A-Z]{1}[0-9LMNPQRSTUUV]{3}[A-Z]{1}				

element **Assegno_Coniuge_Type/Importo**

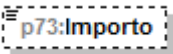
diagram					
namespace	urn:www.agenziaentrate.gov.it:specificheTecniche:sco:p73				
type	DatoNP_Type				
facets	<table border="1"> <thead> <tr> <th>Kind</th> <th>Value</th> </tr> </thead> <tbody> <tr> <td>pattern</td> <td>[1-9]{1}[0-9]*</td> </tr> </tbody> </table>	Kind	Value	pattern	[1-9]{1}[0-9]*
Kind	Value				
pattern	[1-9]{1}[0-9]*				

complexType **Bonus_Irpef_Type**

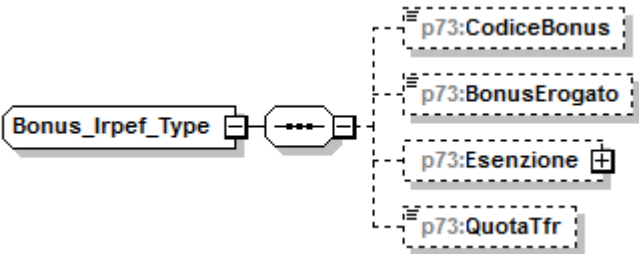
diagram	
namespace	urn:www.agenziaentrate.gov.it:specificheTecniche:sco:p73
children	p73:CodiceBonus p73:BonusErogato p73:Esenzione p73:QuotaTfr

element **Bonus_Irpef_Type/CodiceBonus**

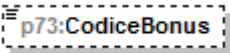
diagram									
namespace	urn:www.agenziaentrate.gov.it:specificheTecniche:sco:p73								
type	restriction of DatoN1_Type								
facets	<table border="1"> <thead> <tr> <th>Kind</th> <th>Value</th> </tr> </thead> <tbody> <tr> <td>pattern</td> <td>[1-9]</td> </tr> <tr> <td>enumeration</td> <td>1</td> </tr> <tr> <td>enumeration</td> <td>2</td> </tr> </tbody> </table>	Kind	Value	pattern	[1-9]	enumeration	1	enumeration	2
Kind	Value								
pattern	[1-9]								
enumeration	1								
enumeration	2								

element **Bonus_Irpef_Type/BonusErogato**

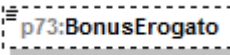
diagram					
namespace	urn:www.agenziaentrate.gov.it:specificheTecniche:sco:p73				
type	DatoNP_Type				
facets	<table border="1"> <thead> <tr> <th>Kind</th> <th>Value</th> </tr> </thead> <tbody> <tr> <td>pattern</td> <td>[1-9]{1}[0-9]*</td> </tr> </tbody> </table>	Kind	Value	pattern	[1-9]{1}[0-9]*
Kind	Value				
pattern	[1-9]{1}[0-9]*				

element **Bonus_Irpef_Type/Esenzione**

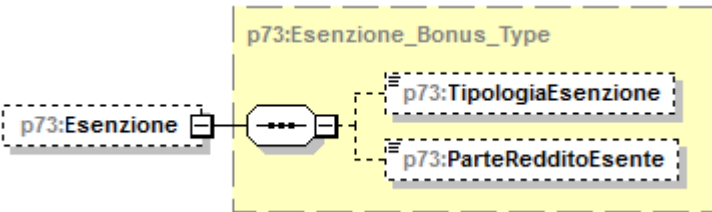
diagram	
namespace	urn:www.agenziaentrate.gov.it:specificheTecniche:sco:p73
type	p73:Esenzione_Bonus_Type
children	p73:TipologiaEsenzione p73:ParteRedditoEsente

element **Bonus_Irpef_Type/QuotaTfr**

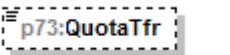
diagram					
namespace	urn:www.agenziaentrate.gov.it:specificheTecniche:sco:p73				
type	DatoNP_Type				
facets	<table border="1"> <thead> <tr> <th>Kind</th> <th>Value</th> </tr> </thead> <tbody> <tr> <td>pattern</td> <td>[1-9]{1}[0-9]*</td> </tr> </tbody> </table>	Kind	Value	pattern	[1-9]{1}[0-9]*
Kind	Value				
pattern	[1-9]{1}[0-9]*				

complexType Casella_Aconto_Type

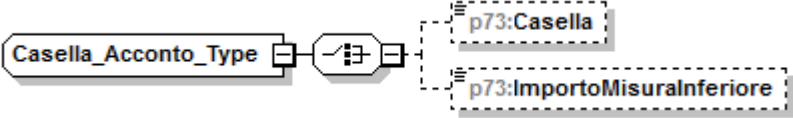
diagram	
namespace	urn:www.agenziaentrate.gov.it:specificheTecniche:sco:p73
children	p73:Casella p73:ImportoMisuralInferiore

element Casella_Aconto_Type/Casella

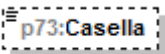
diagram	
namespace	urn:www.agenziaentrate.gov.it:specificheTecniche:sco:p73
type	DatoCB_Type
facets	Kind Value pattern [01]

element Casella_Aconto_Type/ImportoMisuralInferiore

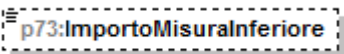
diagram	
namespace	urn:www.agenziaentrate.gov.it:specificheTecniche:sco:p73
type	DatoNP_Type
facets	Kind Value pattern [1-9]{1}[0-9]*

complexType Cedolare_Secca_Type

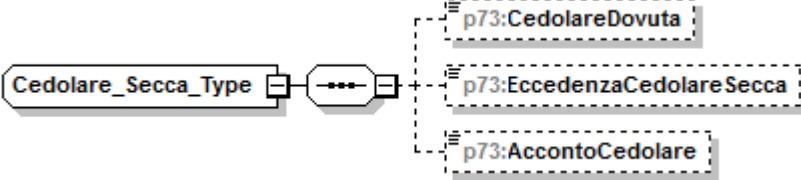
diagram	
namespace	urn:www.agenziaentrate.gov.it:specificheTecniche:sco:p73
children	p73:CedolareDovuta p73:EccedenzaCedolareSecca p73:AccontoCedolare

element Cedolare_Secca_Type/CedolareDovuta

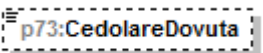
diagram	
namespace	urn:www.agenziaentrate.gov.it:specificheTecniche:sco:p73
type	DatoNP_Type

facets	Kind pattern	Value [1-9]{1}[0-9]*
--------	-----------------	-------------------------

element **Cedolare_Secca_Type/EccedenzaCedolareSecca**

diagram		
namespace	urn:www.agenziaentrate.gov.it:specificheTecniche:sco:p73	
type	DatoNU_Type	
facets	Kind pattern	Value (\-[1-9] [1-9])[0-9]*

element **Cedolare_Secca_Type/AccontoCedolare**

diagram		
namespace	urn:www.agenziaentrate.gov.it:specificheTecniche:sco:p73	
type	DatoNP_Type	
facets	Kind pattern	Value [1-9]{1}[0-9]*

complexType **Conguaglio_Type**

diagram		
namespace	urn:www.agenziaentrate.gov.it:specificheTecniche:sco:p73	
children	p73:NumeroRate p73:ImportoTrattenutoSaldo p73:ImportoTrattenutoAcconto p73:ImportoDaVersareF24Saldo p73:ImportoDaVersareF24Acconto p73:ImportoRimborsato p73:ImportoRimborsatoAgenzia p73:OpzioneInformativa	

element Conguaglio_Type/NumeroRate

diagram																	
namespace	urn:www.agenziaentrate.gov.it:specificheTecniche:sco:p73																
type	restriction of DatoN1_Type																
facets	<table border="1"> <thead> <tr> <th>Kind</th> <th>Value</th> </tr> </thead> <tbody> <tr> <td>pattern</td> <td>[1-9]</td> </tr> <tr> <td>enumeration</td> <td>2</td> </tr> <tr> <td>enumeration</td> <td>3</td> </tr> <tr> <td>enumeration</td> <td>4</td> </tr> <tr> <td>enumeration</td> <td>5</td> </tr> <tr> <td>enumeration</td> <td>6</td> </tr> <tr> <td>enumeration</td> <td>7</td> </tr> </tbody> </table>	Kind	Value	pattern	[1-9]	enumeration	2	enumeration	3	enumeration	4	enumeration	5	enumeration	6	enumeration	7
Kind	Value																
pattern	[1-9]																
enumeration	2																
enumeration	3																
enumeration	4																
enumeration	5																
enumeration	6																
enumeration	7																

element Conguaglio_Type/ImportoTrattenutoSaldo

diagram					
namespace	urn:www.agenziaentrate.gov.it:specificheTecniche:sco:p73				
type	DatoNP_Type				
facets	<table border="1"> <thead> <tr> <th>Kind</th> <th>Value</th> </tr> </thead> <tbody> <tr> <td>pattern</td> <td>[1-9]{1}[0-9]*</td> </tr> </tbody> </table>	Kind	Value	pattern	[1-9]{1}[0-9]*
Kind	Value				
pattern	[1-9]{1}[0-9]*				

element Conguaglio_Type/ImportoTrattenutoAcconto

diagram					
namespace	urn:www.agenziaentrate.gov.it:specificheTecniche:sco:p73				
type	DatoNP_Type				
facets	<table border="1"> <thead> <tr> <th>Kind</th> <th>Value</th> </tr> </thead> <tbody> <tr> <td>pattern</td> <td>[1-9]{1}[0-9]*</td> </tr> </tbody> </table>	Kind	Value	pattern	[1-9]{1}[0-9]*
Kind	Value				
pattern	[1-9]{1}[0-9]*				

element Conguaglio_Type/ImportoDaVersareF24Saldo

diagram					
namespace	urn:www.agenziaentrate.gov.it:specificheTecniche:sco:p73				
type	DatoNP_Type				
facets	<table border="1"> <thead> <tr> <th>Kind</th> <th>Value</th> </tr> </thead> <tbody> <tr> <td>pattern</td> <td>[1-9]{1}[0-9]*</td> </tr> </tbody> </table>	Kind	Value	pattern	[1-9]{1}[0-9]*
Kind	Value				
pattern	[1-9]{1}[0-9]*				

element Conguaglio_Type/ImportoDaVersareF24Acconto

diagram	
namespace	urn:www.agenziaentrate.gov.it:specificheTecniche:sco:p73

type	DatoNP_Type
facets	Kind Value pattern [1-9]{1}[0-9]*

element Conguaglio_Type/ImportoRimborsato

diagram	
namespace	urn:www.agenziaentrate.gov.it:specificheTecniche:sco:p73
type	DatoNP_Type
facets	Kind Value pattern [1-9]{1}[0-9]*

element Conguaglio_Type/ImportoRimborsatoAgenzia

diagram	
namespace	urn:www.agenziaentrate.gov.it:specificheTecniche:sco:p73
type	DatoNP_Type
facets	Kind Value pattern [1-9]{1}[0-9]*

element Conguaglio_Type/OpzioneInformativa

diagram	
namespace	urn:www.agenziaentrate.gov.it:specificheTecniche:sco:p73
type	DatoCB_Type
facets	Kind Value pattern [01]

complexType Contributi_Previdenza_Complementare_Type

diagram	
namespace	urn:www.agenziaentrate.gov.it:specificheTecniche:sco:p73
children	p73:EsclusiDalSostituto p73:NonEsclusiDalSostituto

element Contributi_Previdenza_Complementare_Type/EsclusiDalSostituto

diagram	
---------	--

namespace	urn:www.agenziaentrate.gov.it:specificheTecniche:sco:p73
type	DatoNP_Type
facets	Kind Value pattern [1-9]{1}[0-9]*

element Contributi_Previdenza_Complementare_Type/NonEsclusiDalSostituto

diagram	
namespace	urn:www.agenziaentrate.gov.it:specificheTecniche:sco:p73
type	DatoNP_Type
facets	Kind Value pattern [1-9]{1}[0-9]*

complexType Contributo_Solidarieta_Type

diagram	
namespace	urn:www.agenziaentrate.gov.it:specificheTecniche:sco:p73
children	p73:ImponibileContributo p73:ContributoDovuto p73:ContributoCertificaz

element Contributo_Solidarieta_Type/ImponibileContributo

diagram	
namespace	urn:www.agenziaentrate.gov.it:specificheTecniche:sco:p73
type	DatoNP_Type
facets	Kind Value pattern [1-9]{1}[0-9]*

element Contributo_Solidarieta_Type/ContributoDovuto

diagram	
namespace	urn:www.agenziaentrate.gov.it:specificheTecniche:sco:p73
type	DatoNP_Type
facets	Kind Value pattern [1-9]{1}[0-9]*

element **Contributo_Solidarieta_Type/ContributoCertificaz**

diagram	
namespace	urn:www.agenziaentrate.gov.it:specificheTecniche:sco:p73
type	DatoNP_Type
facets	Kind Value pattern [1-9]{1}[0-9]*

complexType **Cred_Erogazione_Cultura_Type**

diagram	
namespace	urn:www.agenziaentrate.gov.it:specificheTecniche:sco:p73
children	p73:RataAnnoPrec p73:RataAnno

element **Cred_Erogazione_Cultura_Type/RataAnnoPrec**

diagram	
namespace	urn:www.agenziaentrate.gov.it:specificheTecniche:sco:p73
type	DatoNP_Type
facets	Kind Value pattern [1-9]{1}[0-9]*

element **Cred_Erogazione_Cultura_Type/RataAnno**

diagram	
namespace	urn:www.agenziaentrate.gov.it:specificheTecniche:sco:p73
type	DatoNP_Type
facets	Kind Value pattern [1-9]{1}[0-9]*

complexType **Cred_Imp_Estero_Type**

diagram	
namespace	urn:www.agenziaentrate.gov.it:specificheTecniche:sco:p73

children	p73:Anno p73:TotCredito p73:CreditoStato
----------	--

element Cred_Imp_Estero_Type/Anno

diagram	
namespace	urn:www.agenziaentrate.gov.it:specificheTecniche:sco:p73
type	DatoDA Type
facets	Kind Value pattern (18 19 20)[0-9]{2}

element Cred_Imp_Estero_Type/TotCredito

diagram	
namespace	urn:www.agenziaentrate.gov.it:specificheTecniche:sco:p73
type	DatoNP Type
facets	Kind Value pattern [1-9]{1}[0-9]*

element Cred_Imp_Estero_Type/CreditoStato

diagram	
namespace	urn:www.agenziaentrate.gov.it:specificheTecniche:sco:p73
type	p73:Credito_Stato_Type
children	p73:Stato p73:Credito

complexType **Crediti_F24_Type**

<p>diagram</p>	
<p>namespace</p>	<p>urn:www.agenziaentrate.gov.it:specificheTecniche:sco:p73</p>
<p>children</p>	<p>p73:Credlrpef p73:CredlrpefDipNoSostituto p73:CodAddReg p73:CredAddReg p73:CredAddRegDipNoSostituto p73:CodiceAddCom p73:CredAddCom p73:CredAddComDipNoSostituto p73:CredCedolare p73:CredCedolareDipNoSostituto p73:CredTassSeparDipNoSostituto p73:CredImpostaSostDipNoSostituto p73:CredSolidarietaDipNoSostituto p73:Totale p73:TotaleDipNoSostituto</p>

element **Crediti_F24_Type/Credlrpef**

<p>diagram</p>					
<p>namespace</p>	<p>urn:www.agenziaentrate.gov.it:specificheTecniche:sco:p73</p>				
<p>type</p>	<p>DatoNP_Type</p>				
<p>facets</p>	<table border="1"> <tr> <td>Kind</td> <td>Value</td> </tr> <tr> <td>pattern</td> <td>[1-9]{1}[0-9]*</td> </tr> </table>	Kind	Value	pattern	[1-9]{1}[0-9]*
Kind	Value				
pattern	[1-9]{1}[0-9]*				

element Crediti_F24_Type/CredIrpefDipNoSostituto

diagram					
namespace	urn:www.agenziaentrate.gov.it:specificheTecniche:sco:p73				
type	DatoNP_Type				
facets	<table border="1"> <tr> <th>Kind</th> <th>Value</th> </tr> <tr> <td>pattern</td> <td>[1-9]{1}[0-9]*</td> </tr> </table>	Kind	Value	pattern	[1-9]{1}[0-9]*
Kind	Value				
pattern	[1-9]{1}[0-9]*				

element Crediti_F24_Type/CodAddReg

diagram																																															
namespace	urn:www.agenziaentrate.gov.it:specificheTecniche:sco:p73																																														
type	Codice_Regione_Type																																														
facets	<table border="1"> <tr> <th>Kind</th> <th>Value</th> </tr> <tr> <td>pattern</td> <td>([0-9A-Z\-\-] &quot;){1}([0-9A-Z&amp;:] '\-\. , / \^\(\ \)\ À È É ì ò Ù Û &quot; \ \ /+)*</td> </tr> <tr> <td>enumeration</td> <td>1</td> </tr> <tr> <td>enumeration</td> <td>2</td> </tr> <tr> <td>enumeration</td> <td>3</td> </tr> <tr> <td>enumeration</td> <td>4</td> </tr> <tr> <td>enumeration</td> <td>5</td> </tr> <tr> <td>enumeration</td> <td>6</td> </tr> <tr> <td>enumeration</td> <td>7</td> </tr> <tr> <td>enumeration</td> <td>8</td> </tr> <tr> <td>enumeration</td> <td>9</td> </tr> <tr> <td>enumeration</td> <td>10</td> </tr> <tr> <td>enumeration</td> <td>11</td> </tr> <tr> <td>enumeration</td> <td>12</td> </tr> <tr> <td>enumeration</td> <td>13</td> </tr> <tr> <td>enumeration</td> <td>14</td> </tr> <tr> <td>enumeration</td> <td>15</td> </tr> <tr> <td>enumeration</td> <td>16</td> </tr> <tr> <td>enumeration</td> <td>17</td> </tr> <tr> <td>enumeration</td> <td>18</td> </tr> <tr> <td>enumeration</td> <td>19</td> </tr> <tr> <td>enumeration</td> <td>20</td> </tr> <tr> <td>enumeration</td> <td>21</td> </tr> </table>	Kind	Value	pattern	([0-9A-Z\-\-] "){1}([0-9A-Z&:] '\-\. , / \^\(\ \)\ À È É ì ò Ù Û " \ \ /+)*	enumeration	1	enumeration	2	enumeration	3	enumeration	4	enumeration	5	enumeration	6	enumeration	7	enumeration	8	enumeration	9	enumeration	10	enumeration	11	enumeration	12	enumeration	13	enumeration	14	enumeration	15	enumeration	16	enumeration	17	enumeration	18	enumeration	19	enumeration	20	enumeration	21
Kind	Value																																														
pattern	([0-9A-Z\-\-] "){1}([0-9A-Z&:] '\-\. , / \^\(\ \)\ À È É ì ò Ù Û " \ \ /+)*																																														
enumeration	1																																														
enumeration	2																																														
enumeration	3																																														
enumeration	4																																														
enumeration	5																																														
enumeration	6																																														
enumeration	7																																														
enumeration	8																																														
enumeration	9																																														
enumeration	10																																														
enumeration	11																																														
enumeration	12																																														
enumeration	13																																														
enumeration	14																																														
enumeration	15																																														
enumeration	16																																														
enumeration	17																																														
enumeration	18																																														
enumeration	19																																														
enumeration	20																																														
enumeration	21																																														

element Crediti_F24_Type/CredAddReg

diagram					
namespace	urn:www.agenziaentrate.gov.it:specificheTecniche:sco:p73				
type	DatoNP_Type				
facets	<table border="1"> <tr> <th>Kind</th> <th>Value</th> </tr> <tr> <td>pattern</td> <td>[1-9]{1}[0-9]*</td> </tr> </table>	Kind	Value	pattern	[1-9]{1}[0-9]*
Kind	Value				
pattern	[1-9]{1}[0-9]*				

element Crediti_F24_Type/CredAddRegDipNoSostituto

diagram	
namespace	urn:www.agenziaentrate.gov.it:specificheTecniche:sco:p73

type	DatoNP_Type
facets	Kind Value pattern [1-9]{1}[0-9]*

element Crediti_F24_Type/CodiceAddCom

diagram	
namespace	urn:www.agenziaentrate.gov.it:specificheTecniche:sco:p73
type	DatoAN_Type
facets	Kind Value pattern (([0-9A-Z\-\]"){1}([0-9A-Z&:] \- \., / \^\(\ \)\ À É È Ì Ò Ù Û " \ \\ / +)*

element Crediti_F24_Type/CredAddCom

diagram	
namespace	urn:www.agenziaentrate.gov.it:specificheTecniche:sco:p73
type	DatoNP_Type
facets	Kind Value pattern [1-9]{1}[0-9]*

element Crediti_F24_Type/CredAddComDipNoSostituto

diagram	
namespace	urn:www.agenziaentrate.gov.it:specificheTecniche:sco:p73
type	DatoNP_Type
facets	Kind Value pattern [1-9]{1}[0-9]*

element Crediti_F24_Type/CredCedolare

diagram	
namespace	urn:www.agenziaentrate.gov.it:specificheTecniche:sco:p73
type	DatoNP_Type
facets	Kind Value pattern [1-9]{1}[0-9]*

element Crediti_F24_Type/CredCedolareDipNoSostituto

diagram	
namespace	urn:www.agenziaentrate.gov.it:specificheTecniche:sco:p73

type	DatoNP_Type
facets	Kind Value pattern [1-9]{1}[0-9]*

element Crediti_F24_Type/CredTassSeparDipNoSostituto

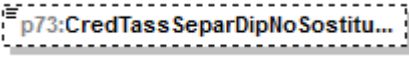
diagram	
namespace	urn:www.agenziaentrate.gov.it:specificheTecniche:sco:p73
type	DatoNP_Type
facets	Kind Value pattern [1-9]{1}[0-9]*

element Crediti_F24_Type/CredImpostaSostDipNoSostituto

diagram	
namespace	urn:www.agenziaentrate.gov.it:specificheTecniche:sco:p73
type	DatoNP_Type
facets	Kind Value pattern [1-9]{1}[0-9]*

element Crediti_F24_Type/CredSolidarietaDipNoSostituto

diagram	
namespace	urn:www.agenziaentrate.gov.it:specificheTecniche:sco:p73
type	DatoNP_Type
facets	Kind Value pattern [1-9]{1}[0-9]*

element Crediti_F24_Type/Totale

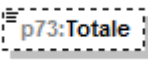
diagram	
namespace	urn:www.agenziaentrate.gov.it:specificheTecniche:sco:p73
type	DatoNP_Type
facets	Kind Value pattern [1-9]{1}[0-9]*

element Crediti_F24_Type/TotaleDipNoSostituto

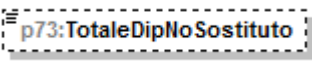
diagram	
namespace	urn:www.agenziaentrate.gov.it:specificheTecniche:sco:p73

type	DatoNP_Type
facets	Kind Value pattern [1-9]{1}[0-9]*

complexType Crediti_Imposta_Altri_Sisma_Abruzzo_Type

diagram	
namespace	urn:www.agenziaentrate.gov.it:specificheTecniche:sco:p73
children	p73:Impresa_Professione p73:CreditoImmobileSismaAbruzzo p73:Rateazione

element Crediti_Imposta_Altri_Sisma_Abruzzo_Type/Impresa_Professione

diagram	
namespace	urn:www.agenziaentrate.gov.it:specificheTecniche:sco:p73
type	DatoCB_Type
facets	Kind Value pattern [01]

element Crediti_Imposta_Altri_Sisma_Abruzzo_Type/CreditoImmobileSismaAbruzzo

diagram	
namespace	urn:www.agenziaentrate.gov.it:specificheTecniche:sco:p73
type	p73:Credito_Immobil..._Type
children	p73:CodiceFiscale p73:NumeroRata p73:TotaleCredito

element Crediti_Imposta_Altri_Sisma_Abruzzo_Type/Rateazione

diagram	
namespace	urn:www.agenziaentrate.gov.it:specificheTecniche:sco:p73
type	p73:Numero_Rate5o10_Type

facets	Kind	Value
	pattern	[1-9]{1}[0-9]*
	enumeration	5
	enumeration	10

complexType Crediti_Imposta_Fabbicati_Type

diagram	
namespace	urn:www.agenziaentrate.gov.it:specificheTecniche:sco:p73
children	p73:ResiduoFabbicati p73:CanoniLocazioneNonPercepiti

element Crediti_Imposta_Fabbicati_Type/ResiduoFabbicati

diagram	
namespace	urn:www.agenziaentrate.gov.it:specificheTecniche:sco:p73
type	p73:Residuo_Fabbicati_Type
children	p73:ResiduoPrecedenteDichiarazione p73:CreditoAnno p73:DiCuiCompensatoF24

element Crediti_Imposta_Fabbicati_Type/CanoniLocazioneNonPercepiti

diagram					
namespace	urn:www.agenziaentrate.gov.it:specificheTecniche:sco:p73				
type	DatoNP_Type				
facets	<table border="1"> <tr> <td>Kind</td> <td>Value</td> </tr> <tr> <td>pattern</td> <td>[1-9]{1}[0-9]*</td> </tr> </table>	Kind	Value	pattern	[1-9]{1}[0-9]*
Kind	Value				
pattern	[1-9]{1}[0-9]*				

complexType **Crediti_Imposta_Fondi_Pensione_Type**

diagram	
namespace	urn:www.agenziaentrate.gov.it:specificheTecniche:sco:p73
children	p73:AnnoAnticipazione p73:Reintegro p73:SommaReintegrata p73:CreditoAnno

element **Crediti_Imposta_Fondi_Pensione_Type/AnnoAnticipazione**

diagram																									
namespace	urn:www.agenziaentrate.gov.it:specificheTecniche:sco:p73																								
type	p73:Anno_Anticipazione_Fondo_Pensione_Type																								
facets	<table border="1"> <thead> <tr> <th>Kind</th> <th>Value</th> </tr> </thead> <tbody> <tr> <td>pattern</td> <td>[1-9]{1}[0-9]*</td> </tr> <tr> <td>enumeration</td> <td>2007</td> </tr> <tr> <td>enumeration</td> <td>2008</td> </tr> <tr> <td>enumeration</td> <td>2009</td> </tr> <tr> <td>enumeration</td> <td>2010</td> </tr> <tr> <td>enumeration</td> <td>2011</td> </tr> <tr> <td>enumeration</td> <td>2012</td> </tr> <tr> <td>enumeration</td> <td>2013</td> </tr> <tr> <td>enumeration</td> <td>2014</td> </tr> <tr> <td>enumeration</td> <td>2015</td> </tr> <tr> <td>enumeration</td> <td>2016</td> </tr> </tbody> </table>	Kind	Value	pattern	[1-9]{1}[0-9]*	enumeration	2007	enumeration	2008	enumeration	2009	enumeration	2010	enumeration	2011	enumeration	2012	enumeration	2013	enumeration	2014	enumeration	2015	enumeration	2016
Kind	Value																								
pattern	[1-9]{1}[0-9]*																								
enumeration	2007																								
enumeration	2008																								
enumeration	2009																								
enumeration	2010																								
enumeration	2011																								
enumeration	2012																								
enumeration	2013																								
enumeration	2014																								
enumeration	2015																								
enumeration	2016																								

element **Crediti_Imposta_Fondi_Pensione_Type/Reintegro**

diagram									
namespace	urn:www.agenziaentrate.gov.it:specificheTecniche:sco:p73								
type	p73:Reintegro_Totale_Parziale_Type								
facets	<table border="1"> <thead> <tr> <th>Kind</th> <th>Value</th> </tr> </thead> <tbody> <tr> <td>pattern</td> <td>[1-9]</td> </tr> <tr> <td>enumeration</td> <td>1</td> </tr> <tr> <td>enumeration</td> <td>2</td> </tr> </tbody> </table>	Kind	Value	pattern	[1-9]	enumeration	1	enumeration	2
Kind	Value								
pattern	[1-9]								
enumeration	1								
enumeration	2								

element **Crediti_Imposta_Fondi_Pensione_Type/SommaReintegrata**

diagram	
namespace	urn:www.agenziaentrate.gov.it:specificheTecniche:sco:p73
type	DatoNP_Type

facets	Kind pattern	Value [1-9]{1}[0-9]*
--------	-----------------	-------------------------

element **Crediti_Imposta_Fondi_Pensione_Type/CreditoAnno**

diagram		
namespace	urn:www.agenziaentrate.gov.it:specificheTecniche:sco:p73	
type	DatoNP_Type	
facets	Kind pattern	Value [1-9]{1}[0-9]*

complexType **Crediti_Imposta_Reddito_Esteri_Type**

diagram		
namespace	urn:www.agenziaentrate.gov.it:specificheTecniche:sco:p73	
children	p73:StatoEstero p73:Anno p73:RedditoEstero p73:ImpostaEstera p73:RedditoComplessivo p73:Imposta_Lorda p73:ImpostaNetta p73:CreditoDichiarazioniPrecedenti p73:DiCuiStatoEstero	

element **Crediti_Imposta_Reddito_Esteri_Type/StatoEstero**

diagram		
namespace	urn:www.agenziaentrate.gov.it:specificheTecniche:sco:p73	
type	DatoAN_Type	
facets	Kind pattern	Value ([0-9A-Z-] \"){1}([0-9A-Z&:] ' \" \- \., / ° ^\(\\ \\) À È É Ì Ò Ù Û " \\ \\ +)*

element **Crediti_Imposta_Redditi_Esteri_Type/Anno**

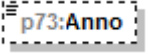
diagram	
namespace	urn:www.agenziaentrate.gov.it:specificheTecniche:sco:p73
type	restriction of DatoDA_Type
facets	Kind Value pattern (18 19 20){0-9}{2}

element **Crediti_Imposta_Redditi_Esteri_Type/RedditoEstero**

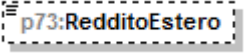
diagram	
namespace	urn:www.agenziaentrate.gov.it:specificheTecniche:sco:p73
type	DatoNP_Type
facets	Kind Value pattern [1-9]{1}[0-9]*

element **Crediti_Imposta_Redditi_Esteri_Type/ImpostaEstera**

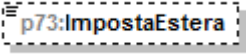
diagram	
namespace	urn:www.agenziaentrate.gov.it:specificheTecniche:sco:p73
type	DatoNP_Type
facets	Kind Value pattern [1-9]{1}[0-9]*

element **Crediti_Imposta_Redditi_Esteri_Type/RedditoComplessivo**

diagram	
namespace	urn:www.agenziaentrate.gov.it:specificheTecniche:sco:p73
type	DatoNP_Type
facets	Kind Value pattern [1-9]{1}[0-9]*

element **Crediti_Imposta_Redditi_Esteri_Type/Imposta_Lorda**

diagram	
namespace	urn:www.agenziaentrate.gov.it:specificheTecniche:sco:p73
type	DatoNP_Type
facets	Kind Value pattern [1-9]{1}[0-9]*

element Crediti_Imposta_Redditi_Esteri_Type/ImpostaNetta

diagram					
namespace	urn:www.agenziaentrate.gov.it:specificheTecniche:sco:p73				
type	DatoNP_Type				
facets	<table border="1"> <tr> <td>Kind</td> <td>Value</td> </tr> <tr> <td>pattern</td> <td>[1-9]{1}[0-9]*</td> </tr> </table>	Kind	Value	pattern	[1-9]{1}[0-9]*
Kind	Value				
pattern	[1-9]{1}[0-9]*				

element Crediti_Imposta_Redditi_Esteri_Type/CreditoDichiarazioniPrecedenti

diagram					
namespace	urn:www.agenziaentrate.gov.it:specificheTecniche:sco:p73				
type	DatoNP_Type				
facets	<table border="1"> <tr> <td>Kind</td> <td>Value</td> </tr> <tr> <td>pattern</td> <td>[1-9]{1}[0-9]*</td> </tr> </table>	Kind	Value	pattern	[1-9]{1}[0-9]*
Kind	Value				
pattern	[1-9]{1}[0-9]*				

element Crediti_Imposta_Redditi_Esteri_Type/DiCuiStatoEstero

diagram					
namespace	urn:www.agenziaentrate.gov.it:specificheTecniche:sco:p73				
type	DatoNP_Type				
facets	<table border="1"> <tr> <td>Kind</td> <td>Value</td> </tr> <tr> <td>pattern</td> <td>[1-9]{1}[0-9]*</td> </tr> </table>	Kind	Value	pattern	[1-9]{1}[0-9]*
Kind	Value				
pattern	[1-9]{1}[0-9]*				

complexType Crediti_Imposta_Type

diagram	
namespace	urn:www.agenziaentrate.gov.it:specificheTecniche:sco:p73
children	p73:PrimoModulo p73:Modulo

element **Crediti_Imposta_Type/PrimoModulo**

<p>diagram</p>	
<p>namespace</p>	<p>urn:www.agenziaentrate.gov.it:specificheTecniche:sco:p73</p>
<p>type</p>	<p>p73:Primo_Modulo_Crediti_Imposta_Type</p>
<p>children</p>	<p>p73:CreditoImpostaFabbricati p73:CreditoImpostaFondiPensione p73:CreditoImpostaRedditiEsteri p73:CreditoPrimaCasaSismaAbruzzo p73:CreditoAltriSismaAbruzzo p73:CreditoIncrementoOccupazione p73:CreditoImpostaMediazioni p73:CreditoErogazioniCultura p73:CreditoNegoziazione p73:CreditoErogazioniScuola p73:CreditoVideosorveglianza</p>

element **Crediti_Imposta_Type/Modulo**

<p>diagram</p>	
<p>namespace</p>	<p>urn:www.agenziaentrate.gov.it:specificheTecniche:sco:p73</p>

type	p73:Modulo_Crediti_Imposta_Type
children	p73:CreditoImpostaFondiPensione p73:CreditoImpostaRedditiEsteri p73:CreditoPrimaCasaSismaAbruzzo p73:CreditoAltriSismaAbruzzo p73:CreditoNegoziazione

complexType **Credito_Erogazioni_Cultura_Type**

diagram	
namespace	urn:www.agenziaentrate.gov.it:specificheTecniche:sco:p73
children	p73:SpesaAnno p73:ResiduoAnnoPrec p73:RataAnnoPrec p73:RataDueAnniPrec

element **Credito_Erogazioni_Cultura_Type/SpesaAnno**

diagram					
namespace	urn:www.agenziaentrate.gov.it:specificheTecniche:sco:p73				
type	DatoNP_Type				
facets	<table border="1"> <tr> <td>Kind</td> <td>Value</td> </tr> <tr> <td>pattern</td> <td>[1-9]{1}[0-9]*</td> </tr> </table>	Kind	Value	pattern	[1-9]{1}[0-9]*
Kind	Value				
pattern	[1-9]{1}[0-9]*				

element **Credito_Erogazioni_Cultura_Type/ResiduoAnnoPrec**

diagram					
namespace	urn:www.agenziaentrate.gov.it:specificheTecniche:sco:p73				
type	DatoNP_Type				
facets	<table border="1"> <tr> <td>Kind</td> <td>Value</td> </tr> <tr> <td>pattern</td> <td>[1-9]{1}[0-9]*</td> </tr> </table>	Kind	Value	pattern	[1-9]{1}[0-9]*
Kind	Value				
pattern	[1-9]{1}[0-9]*				

element **Credito_Erogazioni_Cultura_Type/RataAnnoPrec**

diagram					
namespace	urn:www.agenziaentrate.gov.it:specificheTecniche:sco:p73				
type	DatoNP_Type				
facets	<table border="1"> <tr> <td>Kind</td> <td>Value</td> </tr> <tr> <td>pattern</td> <td>[1-9]{1}[0-9]*</td> </tr> </table>	Kind	Value	pattern	[1-9]{1}[0-9]*
Kind	Value				
pattern	[1-9]{1}[0-9]*				

element Credito_Erogazioni_Cultura_Type/RataDueAnniPrec

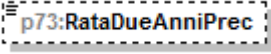
diagram	
namespace	urn:www.agenziaentrate.gov.it:specificheTecniche:sco:p73
type	DatoNP_Type
facets	Kind Value pattern [1-9]{1}[0-9]*

complexType Credito_Erogazioni_Scuola_Type

diagram	
namespace	urn:www.agenziaentrate.gov.it:specificheTecniche:sco:p73
children	p73:SpesaAnno

element Credito_Erogazioni_Scuola_Type/SpesaAnno

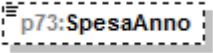
diagram	
namespace	urn:www.agenziaentrate.gov.it:specificheTecniche:sco:p73
type	DatoNP_Type
facets	Kind Value pattern [1-9]{1}[0-9]*

complexType Credito_Immobile_Sisma_Abruzzo_Type

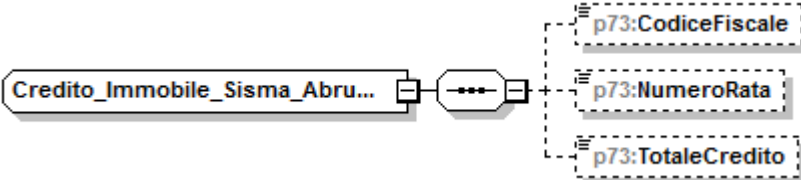
diagram	
namespace	urn:www.agenziaentrate.gov.it:specificheTecniche:sco:p73
children	p73:CodiceFiscale p73:NumeroRata p73:TotaleCredito

element Credito_Immobile_Sisma_Abruzzo_Type/CodiceFiscale

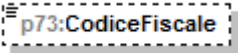
diagram	
namespace	urn:www.agenziaentrate.gov.it:specificheTecniche:sco:p73
type	DatoCF_Type
facets	Kind Value pattern [0-9]{11}[A-Z]{6}[0-9LMNPQRSTUUV]{2}[A-Z]{1}[0-9LMNPQRSTUUV]{2}[A-Z]{1}[0-9LMNPQRSTUUV]{3}[A-Z]{1}

element **Credito_Immibile_Sisma_Abruzzo_Type/NumeroRata**

diagram																					
namespace	urn:www.agenziaentrate.gov.it:specificheTecniche:sco:p73																				
type	restriction of DatoNP_Type																				
facets	<table border="1"> <thead> <tr> <th>Kind</th> <th>Value</th> </tr> </thead> <tbody> <tr> <td>pattern</td> <td>[1-9]{1}[0-9]*</td> </tr> <tr> <td>enumeration</td> <td>1</td> </tr> <tr> <td>enumeration</td> <td>2</td> </tr> <tr> <td>enumeration</td> <td>3</td> </tr> <tr> <td>enumeration</td> <td>4</td> </tr> <tr> <td>enumeration</td> <td>5</td> </tr> <tr> <td>enumeration</td> <td>6</td> </tr> <tr> <td>enumeration</td> <td>7</td> </tr> <tr> <td>enumeration</td> <td>8</td> </tr> </tbody> </table>	Kind	Value	pattern	[1-9]{1}[0-9]*	enumeration	1	enumeration	2	enumeration	3	enumeration	4	enumeration	5	enumeration	6	enumeration	7	enumeration	8
Kind	Value																				
pattern	[1-9]{1}[0-9]*																				
enumeration	1																				
enumeration	2																				
enumeration	3																				
enumeration	4																				
enumeration	5																				
enumeration	6																				
enumeration	7																				
enumeration	8																				

element **Credito_Immibile_Sisma_Abruzzo_Type/TotaleCredito**

diagram					
namespace	urn:www.agenziaentrate.gov.it:specificheTecniche:sco:p73				
type	DatoNP_Type				
facets	<table border="1"> <thead> <tr> <th>Kind</th> <th>Value</th> </tr> </thead> <tbody> <tr> <td>pattern</td> <td>[1-9]{1}[0-9]*</td> </tr> </tbody> </table>	Kind	Value	pattern	[1-9]{1}[0-9]*
Kind	Value				
pattern	[1-9]{1}[0-9]*				

complexType **Credito_Negoziatore_Type**

diagram	
namespace	urn:www.agenziaentrate.gov.it:specificheTecniche:sco:p73
children	p73:CreditoSpettante p73:ResiduoAnnoPrec p73:DiCuiCompensatoF24

element **Credito_Negoziatore_Type/CreditoSpettante**

diagram					
namespace	urn:www.agenziaentrate.gov.it:specificheTecniche:sco:p73				
type	DatoNP_Type				
facets	<table border="1"> <thead> <tr> <th>Kind</th> <th>Value</th> </tr> </thead> <tbody> <tr> <td>pattern</td> <td>[1-9]{1}[0-9]*</td> </tr> </tbody> </table>	Kind	Value	pattern	[1-9]{1}[0-9]*
Kind	Value				
pattern	[1-9]{1}[0-9]*				

element Credito_Negoziazione_Type/ResiduoAnnoPrec

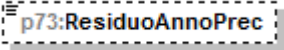
diagram	
namespace	urn:www.agenziaentrate.gov.it:specificheTecniche:sco:p73
type	DatoNP_Type
facets	Kind Value pattern [1-9]{1}[0-9]*

element Credito_Negoziazione_Type/DiCuiCompensatoF24

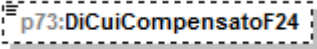
diagram	
namespace	urn:www.agenziaentrate.gov.it:specificheTecniche:sco:p73
type	DatoNP_Type
facets	Kind Value pattern [1-9]{1}[0-9]*

complexType Credito_Stato_Type

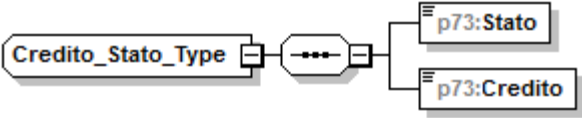
diagram	
namespace	urn:www.agenziaentrate.gov.it:specificheTecniche:sco:p73
children	p73:Stato p73:Credito

element Credito_Stato_Type/Stato

diagram	
namespace	urn:www.agenziaentrate.gov.it:specificheTecniche:sco:p73
type	DatoAN_Type
facets	Kind Value pattern ([0-9A-Z\-\"]{1} ([0-9A-Z&:] [\-\.\, /°\^\(\)\!@ É È Ì Ò Ù Û " \ \ /+)*

element Credito_Stato_Type/Credito

diagram	
namespace	urn:www.agenziaentrate.gov.it:specificheTecniche:sco:p73
type	DatoNP_Type
facets	Kind Value pattern [1-9]{1}[0-9]*

complexType Credito_Type

diagram	
namespace	urn:www.agenziaentrate.gov.it:specificheTecniche:sco:p73
children	p73:NonRimborsabile p73:Credito p73:CreditoF24 p73:CreditoRimborso

element Credito_Type/NonRimborsabile

diagram					
namespace	urn:www.agenziaentrate.gov.it:specificheTecniche:sco:p73				
type	DatoNP_Type				
facets	<table border="1"> <tr> <th>Kind</th> <th>Value</th> </tr> <tr> <td>pattern</td> <td>[1-9]{1}[0-9]*</td> </tr> </table>	Kind	Value	pattern	[1-9]{1}[0-9]*
Kind	Value				
pattern	[1-9]{1}[0-9]*				

element Credito_Type/Credito

diagram					
namespace	urn:www.agenziaentrate.gov.it:specificheTecniche:sco:p73				
type	DatoNP_Type				
facets	<table border="1"> <tr> <th>Kind</th> <th>Value</th> </tr> <tr> <td>pattern</td> <td>[1-9]{1}[0-9]*</td> </tr> </table>	Kind	Value	pattern	[1-9]{1}[0-9]*
Kind	Value				
pattern	[1-9]{1}[0-9]*				

element Credito_Type/CreditoF24

diagram					
namespace	urn:www.agenziaentrate.gov.it:specificheTecniche:sco:p73				
type	DatoNP_Type				
facets	<table border="1"> <tr> <th>Kind</th> <th>Value</th> </tr> <tr> <td>pattern</td> <td>[1-9]{1}[0-9]*</td> </tr> </table>	Kind	Value	pattern	[1-9]{1}[0-9]*
Kind	Value				
pattern	[1-9]{1}[0-9]*				

element Credito_Type/CreditoRimborso

diagram	
---------	--

namespace	urn:www.agenziaentrate.gov.it:specificheTecniche:sco:p73
type	DatoNP_Type
facets	Kind Value pattern [1-9]{1}[0-9]*

complexType Credito_Videosorveglianza_Type

diagram	
namespace	urn:www.agenziaentrate.gov.it:specificheTecniche:sco:p73
children	p73:CreditoSpettante p73:DiCuiCompensatoF24

element Credito_Videosorveglianza_Type/CreditoSpettante

diagram	
namespace	urn:www.agenziaentrate.gov.it:specificheTecniche:sco:p73
type	DatoNP_Type
facets	Kind Value pattern [1-9]{1}[0-9]*

element Credito_Videosorveglianza_Type/DiCuiCompensatoF24

diagram	
namespace	urn:www.agenziaentrate.gov.it:specificheTecniche:sco:p73
type	DatoNP_Type
facets	Kind Value pattern [1-9]{1}[0-9]*

complexType Dati_730_Integrativo_Type

diagram	
namespace	urn:www.agenziaentrate.gov.it:specificheTecniche:sco:p73
children	p73:Rimborso p73:Credito

element **Dati_730_Integrativo_Type/Rimborso**

diagram	
namespace	urn:www.agenziaentrate.gov.it:specificheTecniche:sco:p73
type	p73:Elemento_Integrativo_Type
children	p73:Irpef p73:AddizionaleRegionaleIrpef p73:AddComunaleIrpef p73:CedolareSecca

element **Dati_730_Integrativo_Type/Credito**

diagram	
namespace	urn:www.agenziaentrate.gov.it:specificheTecniche:sco:p73
type	p73:Elemento_Integrativo_Type
children	p73:Irpef p73:AddizionaleRegionaleIrpef p73:AddComunaleIrpef p73:CedolareSecca

complexType **Dati_Altre_Detrazioni_Modulo_Type**

diagram	
namespace	urn:www.agenziaentrate.gov.it:specificheTecniche:sco:p73
children	p73:AltreDetrazioni

element Dati_Altre_Detrazioni_Modulo_Type/AltreDetrazioni

diagram	
namespace	urn:www.agenziaentrate.gov.it:specificheTecniche:sco:p73
type	p73:Altre_Detrazioni_Type
children	p73:Codice p73:Importo

complexType Dati_Altre_Detrazioni_Type

diagram	
namespace	urn:www.agenziaentrate.gov.it:specificheTecniche:sco:p73
children	p73:SpeseCaniGuida p73:AffittoTerreniAgricoliGiovani p73:AltreDetrazioni

element Dati_Altre_Detrazioni_Type/SpeseCaniGuida

diagram					
namespace	urn:www.agenziaentrate.gov.it:specificheTecniche:sco:p73				
type	DatoCB_Type				
facets	<table border="1"> <thead> <tr> <th>Kind</th> <th>Value</th> </tr> </thead> <tbody> <tr> <td>pattern</td> <td>[01]</td> </tr> </tbody> </table>	Kind	Value	pattern	[01]
Kind	Value				
pattern	[01]				

element Dati_Altre_Detrazioni_Type/AffittoTerreniAgricoliGiovani

diagram					
namespace	urn:www.agenziaentrate.gov.it:specificheTecniche:sco:p73				
type	DatoNP_Type				
facets	<table border="1"> <thead> <tr> <th>Kind</th> <th>Value</th> </tr> </thead> <tbody> <tr> <td>pattern</td> <td>[1-9]{1}[0-9]*</td> </tr> </tbody> </table>	Kind	Value	pattern	[1-9]{1}[0-9]*
Kind	Value				
pattern	[1-9]{1}[0-9]*				

element Dati_Altre_Detrazioni_Type/AltreDetrazioni

diagram	
namespace	urn:www.agenziaentrate.gov.it:specificheTecniche:sco:p73
type	p73:Altre_Detrazioni_Type
children	p73:Codice p73:Importo

complexType Dati_Catastali_Recupero_Patrimonio_Edilizio_Type

diagram	
namespace	urn:www.agenziaentrate.gov.it:specificheTecniche:sco:p73
children	p73:NOrdImmibile p73:Condominio p73:DatiCatastali

element Dati_Catastali_Recupero_Patrimonio_Edilizio_Type/NOrdImmibile

diagram					
namespace	urn:www.agenziaentrate.gov.it:specificheTecniche:sco:p73				
type	DatoNP_Type				
facets	<table border="1"> <thead> <tr> <th>Kind</th> <th>Value</th> </tr> </thead> <tbody> <tr> <td>pattern</td> <td>[1-9]{1}[0-9]*</td> </tr> </tbody> </table>	Kind	Value	pattern	[1-9]{1}[0-9]*
Kind	Value				
pattern	[1-9]{1}[0-9]*				

element Dati_Catastali_Recupero_Patrimonio_Edilizio_Type/Condominio

diagram					
namespace	urn:www.agenziaentrate.gov.it:specificheTecniche:sco:p73				
type	DatoCB_Type				
facets	<table border="1"> <thead> <tr> <th>Kind</th> <th>Value</th> </tr> </thead> <tbody> <tr> <td>pattern</td> <td>[01]</td> </tr> </tbody> </table>	Kind	Value	pattern	[01]
Kind	Value				
pattern	[01]				

element **Dati_Catastali_Recupero_Patrimonio_Edilizio_Type/DatiCatastali**

diagram	
namespace	urn:www.agenziaentrate.gov.it:specificheTecniche:sco:p73
type	p73:Dati_Catastali_Type
children	p73:CodiceComune p73:TerreniUrbano p73:SezioneUrbanaComuneCatastale p73:Foglio p73:Particella p73:Subalterno

complexType **Dati_Catastali_Type**

diagram	
namespace	urn:www.agenziaentrate.gov.it:specificheTecniche:sco:p73
children	p73:CodiceComune p73:TerreniUrbano p73:SezioneUrbanaComuneCatastale p73:Foglio p73:Particella p73:Subalterno

element **Dati_Catastali_Type/CodiceComune**

diagram					
namespace	urn:www.agenziaentrate.gov.it:specificheTecniche:sco:p73				
type	DatoAN_Type				
facets	<table border="0"> <tr> <td>Kind</td> <td>Value</td> </tr> <tr> <td>pattern</td> <td>(([0-9A-Z-] \&quot;){1}([0-9A-Z&amp;] '\ - \., /°\^\(\)\ À É È Ì Ò Ù Û &quot; \ \\ \ +)*</td> </tr> </table>	Kind	Value	pattern	(([0-9A-Z-] \"){1}([0-9A-Z&] '\ - \., /°\^\(\)\ À É È Ì Ò Ù Û " \ \\ \ +)*
Kind	Value				
pattern	(([0-9A-Z-] \"){1}([0-9A-Z&] '\ - \., /°\^\(\)\ À É È Ì Ò Ù Û " \ \\ \ +)*				

element Dati_Catastali_Type/TerreniUrbano

diagram									
namespace	urn:www.agenziaentrate.gov.it:specificheTecniche:sco:p73								
type	p73:Terreni Urbano Type								
facets	<table border="0"> <tr> <td>Kind</td> <td>Value</td> </tr> <tr> <td>pattern</td> <td>(([0-9A-Z\-\]]&quot;){1}([0-9A-Z&amp;]] \- \., / ° °\°\(\)\ À È É Ì Ò Ù Û &quot; \ \\ \ +)*</td> </tr> <tr> <td>enumeration</td> <td>T</td> </tr> <tr> <td>enumeration</td> <td>U</td> </tr> </table>	Kind	Value	pattern	(([0-9A-Z\-\]]"){1}([0-9A-Z&]] \- \., / ° °\°\(\)\ À È É Ì Ò Ù Û " \ \\ \ +)*	enumeration	T	enumeration	U
Kind	Value								
pattern	(([0-9A-Z\-\]]"){1}([0-9A-Z&]] \- \., / ° °\°\(\)\ À È É Ì Ò Ù Û " \ \\ \ +)*								
enumeration	T								
enumeration	U								

element Dati_Catastali_Type/SezioneUrbanaComuneCatastale

diagram					
namespace	urn:www.agenziaentrate.gov.it:specificheTecniche:sco:p73				
type	DatoAN Type				
facets	<table border="0"> <tr> <td>Kind</td> <td>Value</td> </tr> <tr> <td>pattern</td> <td>(([0-9A-Z\-\]]&quot;){1}([0-9A-Z&amp;]] \- \., / ° °\°\(\)\ À È É Ì Ò Ù Û &quot; \ \\ \ +)*</td> </tr> </table>	Kind	Value	pattern	(([0-9A-Z\-\]]"){1}([0-9A-Z&]] \- \., / ° °\°\(\)\ À È É Ì Ò Ù Û " \ \\ \ +)*
Kind	Value				
pattern	(([0-9A-Z\-\]]"){1}([0-9A-Z&]] \- \., / ° °\°\(\)\ À È É Ì Ò Ù Û " \ \\ \ +)*				

element Dati_Catastali_Type/Foglio

diagram					
namespace	urn:www.agenziaentrate.gov.it:specificheTecniche:sco:p73				
type	DatoAN Type				
facets	<table border="0"> <tr> <td>Kind</td> <td>Value</td> </tr> <tr> <td>pattern</td> <td>(([0-9A-Z\-\]]&quot;){1}([0-9A-Z&amp;]] \- \., / ° °\°\(\)\ À È É Ì Ò Ù Û &quot; \ \\ \ +)*</td> </tr> </table>	Kind	Value	pattern	(([0-9A-Z\-\]]"){1}([0-9A-Z&]] \- \., / ° °\°\(\)\ À È É Ì Ò Ù Û " \ \\ \ +)*
Kind	Value				
pattern	(([0-9A-Z\-\]]"){1}([0-9A-Z&]] \- \., / ° °\°\(\)\ À È É Ì Ò Ù Û " \ \\ \ +)*				

element Dati_Catastali_Type/Particella

diagram	
namespace	urn:www.agenziaentrate.gov.it:specificheTecniche:sco:p73
children	p73:Numeratore p73:Denominatore

element Dati_Catastali_Type/Particella/Numeratore

diagram	
namespace	urn:www.agenziaentrate.gov.it:specificheTecniche:sco:p73

type	DatoAN_Type
facets	Kind Value pattern ([0-9A-Z\-_]{1}{[0-9A-Z&:] \-\ \.\ / \^\(\ \)\ À É È Ì Ò Ù Û " \ \ \ +)*

element Dati_Catastali_Type/Particella/Denominatore

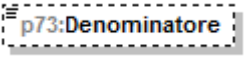
diagram	
namespace	urn:www.agenziaentrate.gov.it:specificheTecniche:sco:p73
type	DatoAN_Type
facets	Kind Value pattern ([0-9A-Z\-_]{1}{[0-9A-Z&:] \-\ \.\ / \^\(\ \)\ À É È Ì Ò Ù Û " \ \ \ +)*

element Dati_Catastali_Type/Subalterno

diagram	
namespace	urn:www.agenziaentrate.gov.it:specificheTecniche:sco:p73
type	DatoAN_Type
facets	Kind Value pattern ([0-9A-Z\-_]{1}{[0-9A-Z&:] \-\ \.\ / \^\(\ \)\ À É È Ì Ò Ù Û " \ \ \ +)*

complexType Dati_Coniuge_Type

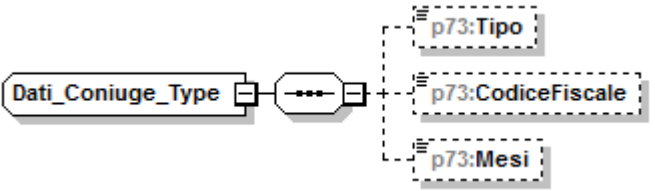
diagram	
namespace	urn:www.agenziaentrate.gov.it:specificheTecniche:sco:p73
children	p73:Tipo p73:CodiceFiscale p73:Mesi

element Dati_Coniuge_Type/Tipo

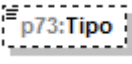
diagram	
namespace	urn:www.agenziaentrate.gov.it:specificheTecniche:sco:p73
type	DatoCB_Type
facets	Kind Value pattern [01]

element **Dati_Coniuge_Type/CodiceFiscale**

diagram					
namespace	urn:www.agenziaentrate.gov.it:specificheTecniche:sco:p73				
type	DatoCF_Type				
facets	<table border="1"> <thead> <tr> <th>Kind</th> <th>Value</th> </tr> </thead> <tbody> <tr> <td>pattern</td> <td>[0-9]{11}[A-Z]{6}[0-9LMNPQRSTU]{2}[A-Z]{1}[0-9LMNPQRSTU]{2}[A-Z]{1}[0-9LMNPQRSTU]{3}[A-Z]{1}</td> </tr> </tbody> </table>	Kind	Value	pattern	[0-9]{11}[A-Z]{6}[0-9LMNPQRSTU]{2}[A-Z]{1}[0-9LMNPQRSTU]{2}[A-Z]{1}[0-9LMNPQRSTU]{3}[A-Z]{1}
Kind	Value				
pattern	[0-9]{11}[A-Z]{6}[0-9LMNPQRSTU]{2}[A-Z]{1}[0-9LMNPQRSTU]{2}[A-Z]{1}[0-9LMNPQRSTU]{3}[A-Z]{1}				

element **Dati_Coniuge_Type/Mesi**

diagram																													
namespace	urn:www.agenziaentrate.gov.it:specificheTecniche:sco:p73																												
type	p73:Mesi_Type																												
facets	<table border="1"> <thead> <tr> <th>Kind</th> <th>Value</th> </tr> </thead> <tbody> <tr> <td>pattern</td> <td>[1-9]{1}[0-9]*</td> </tr> <tr> <td>enumeration</td> <td>1</td> </tr> <tr> <td>enumeration</td> <td>2</td> </tr> <tr> <td>enumeration</td> <td>3</td> </tr> <tr> <td>enumeration</td> <td>4</td> </tr> <tr> <td>enumeration</td> <td>5</td> </tr> <tr> <td>enumeration</td> <td>6</td> </tr> <tr> <td>enumeration</td> <td>7</td> </tr> <tr> <td>enumeration</td> <td>8</td> </tr> <tr> <td>enumeration</td> <td>9</td> </tr> <tr> <td>enumeration</td> <td>10</td> </tr> <tr> <td>enumeration</td> <td>11</td> </tr> <tr> <td>enumeration</td> <td>12</td> </tr> </tbody> </table>	Kind	Value	pattern	[1-9]{1}[0-9]*	enumeration	1	enumeration	2	enumeration	3	enumeration	4	enumeration	5	enumeration	6	enumeration	7	enumeration	8	enumeration	9	enumeration	10	enumeration	11	enumeration	12
Kind	Value																												
pattern	[1-9]{1}[0-9]*																												
enumeration	1																												
enumeration	2																												
enumeration	3																												
enumeration	4																												
enumeration	5																												
enumeration	6																												
enumeration	7																												
enumeration	8																												
enumeration	9																												
enumeration	10																												
enumeration	11																												
enumeration	12																												

complexType **Dati_Contabili_Type**

diagram	
namespace	urn:www.agenziaentrate.gov.it:specificheTecniche:sco:p73

children	p73:Familiari p73:QuadroA p73:QuadroB p73:QuadroC p73:QuadroD p73:QuadroE p73:QuadroF p73:QuadroG p73:ProspettoLiquidazione
----------	--

element Dati_Contabili_Type/Familiari

diagram	
namespace	urn:www.agenziaentrate.gov.it:specificheTecniche:sco:p73
type	p73:Familiari_Type
children	p73:PrimoModulo p73:Modulo

element Dati_Contabili_Type/QuadroA

diagram	
namespace	urn:www.agenziaentrate.gov.it:specificheTecniche:sco:p73
type	p73:Redditi_Terreni_Type
children	p73:Modulo

element Dati_Contabili_Type/QuadroB

diagram	
namespace	urn:www.agenziaentrate.gov.it:specificheTecniche:sco:p73
type	p73:Redditi_Fabbricati_Type
children	p73:Modulo

element **Dati_Contabili_Type/QuadroC**

diagram	
namespace	urn:www.agenziaentrate.gov.it:specificheTecniche:sco:p73
type	p73:Redditi_Lavoro_Dip_Type
children	p73:PrimoModulo p73:Modulo

element **Dati_Contabili_Type/QuadroD**

diagram	
namespace	urn:www.agenziaentrate.gov.it:specificheTecniche:sco:p73
type	extension of p73:Altri_Redditi_Type
children	p73:Modulo

element **Dati_Contabili_Type/QuadroE**

diagram	
namespace	urn:www.agenziaentrate.gov.it:specificheTecniche:sco:p73
type	p73:Oneri_Type
children	p73:PrimoModulo p73:Modulo

element Dati_Contabili_Type/QuadroF

diagram	
namespace	urn:www.agenziaentrate.gov.it:specificheTecniche:sco:p73
type	p73:Acconti_Ritenute_Type
children	p73:PrimoModulo p73:Modulo

element Dati_Contabili_Type/QuadroG

diagram	
namespace	urn:www.agenziaentrate.gov.it:specificheTecniche:sco:p73
type	p73:Crediti_Imposta_Type
children	p73:PrimoModulo p73:Modulo

element Dati_Contabili_Type/ProspettoLiquidazione

diagram	
namespace	urn:www.agenziaentrate.gov.it:specificheTecniche:sco:p73
type	p73:Prospetto_Liquidazione_Type
children	p73:PrimoModulo p73:Modulo

complexType Dati_Contratto_Type

diagram	
namespace	urn:www.agenziaentrate.gov.it:specificheTecniche:sco:p73
children	p73:DataRegContratto p73:SerieContratto p73:NumeroContratto p73:Sottonumero p73:CodiceUfficio p73:IdentificativoContratto

element Dati_Contratto_Type/DataRegContratto

diagram					
namespace	urn:www.agenziaentrate.gov.it:specificheTecniche:sco:p73				
type	DatoDT_Type				
facets	<table border="1"> <thead> <tr> <th>Kind</th> <th>Value</th> </tr> </thead> <tbody> <tr> <td>pattern</td> <td>((([0-9]{1,2} [12][0-9] 3[01])(0[13578] 10 12)\d{4}) ((([0-9]{1,2} [12][0-9] 30)(0[469] 11)\d{4}) ((0[1-9] 1[0-9] 2[0-8])(02\d{4}) ((29)(02)([02468][048]00)) ((29)(02)([13579][26]00)) ((29)(02)([0-9][0-9][0-9][48]) ((29)(02)([0-9][0-9][2468][048]) ((29)(02)([0-9][0-9][13579][26]))))</td> </tr> </tbody> </table>	Kind	Value	pattern	((([0-9]{1,2} [12][0-9] 3[01])(0[13578] 10 12)\d{4}) ((([0-9]{1,2} [12][0-9] 30)(0[469] 11)\d{4}) ((0[1-9] 1[0-9] 2[0-8])(02\d{4}) ((29)(02)([02468][048]00)) ((29)(02)([13579][26]00)) ((29)(02)([0-9][0-9][0-9][48]) ((29)(02)([0-9][0-9][2468][048]) ((29)(02)([0-9][0-9][13579][26]))))
Kind	Value				
pattern	((([0-9]{1,2} [12][0-9] 3[01])(0[13578] 10 12)\d{4}) ((([0-9]{1,2} [12][0-9] 30)(0[469] 11)\d{4}) ((0[1-9] 1[0-9] 2[0-8])(02\d{4}) ((29)(02)([02468][048]00)) ((29)(02)([13579][26]00)) ((29)(02)([0-9][0-9][0-9][48]) ((29)(02)([0-9][0-9][2468][048]) ((29)(02)([0-9][0-9][13579][26]))))				

element Dati_Contratto_Type/SerieContratto

diagram															
namespace	urn:www.agenziaentrate.gov.it:specificheTecniche:sco:p73														
type	p73:Serie_Registrazione_Contratto_Type														
facets	<table border="1"> <thead> <tr> <th>Kind</th> <th>Value</th> </tr> </thead> <tbody> <tr> <td>pattern</td> <td>([0-9A-Z-])&quot;{1}([0-9A-Z&amp;:] [-\., /°\^\\(\) À É Ê Ï Ò Ù Û &quot; \n \\+)*</td> </tr> <tr> <td>enumeration</td> <td>3</td> </tr> <tr> <td>enumeration</td> <td>3A</td> </tr> <tr> <td>enumeration</td> <td>3B</td> </tr> <tr> <td>enumeration</td> <td>3P</td> </tr> <tr> <td>enumeration</td> <td>3T</td> </tr> </tbody> </table>	Kind	Value	pattern	([0-9A-Z-])"{1}([0-9A-Z&:] [-\., /°\^\\(\) À É Ê Ï Ò Ù Û " \n \\+)*	enumeration	3	enumeration	3A	enumeration	3B	enumeration	3P	enumeration	3T
Kind	Value														
pattern	([0-9A-Z-])"{1}([0-9A-Z&:] [-\., /°\^\\(\) À É Ê Ï Ò Ù Û " \n \\+)*														
enumeration	3														
enumeration	3A														
enumeration	3B														
enumeration	3P														
enumeration	3T														

element Dati_Contratto_Type/NumeroContratto

diagram	
namespace	urn:www.agenziaentrate.gov.it:specificheTecniche:sco:p73
type	DatoAN_Type

facets	Kind Value pattern (([0-9A-Z\-\]]"){1}([0-9A-Z&:] ' \"- \. , / ° '^\(\\ \\) À É Ê Ì Ò Ù Û " \\ \\ \\ +)*
--------	--

element Dati_Contratto_Type/Sottonumero

diagram	
namespace	urn:www.agenziaentrate.gov.it:specificheTecniche:sco:p73
type	DatoAN_Type
facets	Kind Value pattern (([0-9A-Z\-\]]"){1}([0-9A-Z&:] ' \"- \. , / ° '^\(\\ \\) À É Ê Ì Ò Ù Û " \\ \\ \\ +)*

element Dati_Contratto_Type/CodiceUfficio

diagram	
namespace	urn:www.agenziaentrate.gov.it:specificheTecniche:sco:p73
type	restriction of DatoAN_Type
facets	Kind Value pattern (([0-9A-Z\-\]]"){1}([0-9A-Z&:] ' \"- \. , / ° '^\(\\ \\) À É Ê Ì Ò Ù Û " \\ \\ \\ +)*

element Dati_Contratto_Type/IdentificativoContratto

diagram	
namespace	urn:www.agenziaentrate.gov.it:specificheTecniche:sco:p73
type	DatoAN_Type
facets	Kind Value pattern (([0-9A-Z\-\]]"){1}([0-9A-Z&:] ' \"- \. , / ° '^\(\\ \\) À É Ê Ì Ò Ù Û " \\ \\ \\ +)*

complexType Dati_Familiare_Type

diagram	
namespace	urn:www.agenziaentrate.gov.it:specificheTecniche:sco:p73
children	p73:CodiceFiscale p73:Mesi p73:MesiMinore p73:PercDetraz p73:PercDetrazCon p73:Affidamento

element Dati_Familiare_Type/CodiceFiscale

diagram	
namespace	urn:www.agenziaentrate.gov.it:specificheTecniche:sco:p73
type	DatoCF_Type
facets	Kind Value pattern [0-9]{11}[A-Z]{6}[0-9LMNPQRSTUVWXYZ]{2}[A-Z]{1}[0-9LMNPQRSTUVWXYZ]{2}[A-Z]{1}[0-9LMNPQRSTUVWXYZ]{3}[A-Z]{1}

element Dati_Familiare_Type/Mesi

diagram	
namespace	urn:www.agenziaentrate.gov.it:specificheTecniche:sco:p73
type	DatoNP_Type
facets	Kind Value pattern [1-9]{1}[0-9]*

element Dati_Familiare_Type/MesiMinore

diagram	
namespace	urn:www.agenziaentrate.gov.it:specificheTecniche:sco:p73
type	DatoNP_Type
facets	Kind Value pattern [1-9]{1}[0-9]*

element Dati_Familiare_Type/PercDetraz

diagram	
namespace	urn:www.agenziaentrate.gov.it:specificheTecniche:sco:p73
type	DatoPC_Type
facets	Kind Value pattern [0-9]?[0-9](, d{1,3})? 100,(0{1,3})?

element Dati_Familiare_Type/PercDetrazCon

diagram	
namespace	urn:www.agenziaentrate.gov.it:specificheTecniche:sco:p73
type	DatoAN_Type
facets	Kind Value pattern ([0-9A-Z-] \"){1}([0-9A-Z&] ' \" _ / ° \"\\(\\) À É È Ì Ò Ù Ú " \\N \\+)*

element Dati_Familiare_Type/Affidamento

diagram	
namespace	urn:www.agenziaentrate.gov.it:specificheTecniche:sco:p73
type	DatoCB_Type
facets	Kind Value pattern [01]

complexType Dati_Nascita_PF_Type

diagram	
namespace	urn:www.agenziaentrate.gov.it:specificheTecniche:sco:p73
children	p73:Sesso p73:DataNascita p73:ComuneNascita p73:ProvinciaNascita

element Dati_Nascita_PF_Type/Sesso

diagram	
namespace	urn:www.agenziaentrate.gov.it:specificheTecniche:sco:p73
type	Sesso_Type
facets	Kind Value pattern ([0-9A-Z-] \"){1}([0-9A-Z&] ' \-\. , /° √\(\)\ À È É Ì Ò Ù Û \" \N\ +)* enumeration M enumeration F

element Dati_Nascita_PF_Type/DataNascita

diagram	
namespace	urn:www.agenziaentrate.gov.it:specificheTecniche:sco:p73
type	DatoDT_Type
facets	Kind Value pattern (((0[1-9][12][0-9][301])(0[13578][1012](\d{4}))) ((0[1-9][12][0-9][30](0[469][11](\d{4}))) ((0[1-9][1[0-9]]2[0-8])(02(\d{4}))) ((29)(02)([02468][048]00))) ((29)(02)([13579][26]00))) ((29)(02)([0-9][0-9][0][48])) ((29)(02)([0-9][0-9][2468][048])) ((29)(02)([0-9][0-9][13579][26]))))

element Dati_Nascita_PF_Type/ComuneNascita

diagram	
namespace	urn:www.agenziaentrate.gov.it:specificheTecniche:sco:p73
type	DatoAN_Type
facets	Kind Value pattern (([0-9A-Z-] "){1}([0-9A-Z&] ' \"- \\. / ° \\^\\(\\ \\)\\À È É Ì Ò Ù Û "; \\ \\ \\ +)*

element Dati_Nascita_PF_Type/ProvinciaNascita

diagram	
namespace	urn:www.agenziaentrate.gov.it:specificheTecniche:sco:p73
type	PN_Type

complexType Dati_Primo_Figlio_Type

diagram	
namespace	urn:www.agenziaentrate.gov.it:specificheTecniche:sco:p73
children	p73:Tipo p73:CodiceFiscale p73:Mesi p73:MesiMinore p73:PercDetraz p73:Affidamento

element Dati_Primo_Figlio_Type/Tipo

diagram	
namespace	urn:www.agenziaentrate.gov.it:specificheTecniche:sco:p73
type	restriction of DatoAN_Type
facets	Kind Value pattern (([0-9A-Z-] "){1}([0-9A-Z&] ' \"- \\. / ° \\^\\(\\ \\)\\À È É Ì Ò Ù Û "; \\ \\ \\ +)* enumeration F enumeration D

element Dati_Primo_Figlio_Type/CodiceFiscale

diagram					
namespace	urn:www.agenziaentrate.gov.it:specificheTecniche:sco:p73				
type	DatoCF_Type				
facets	<table border="1"> <thead> <tr> <th>Kind</th> <th>Value</th> </tr> </thead> <tbody> <tr> <td>pattern</td> <td>[0-9]{11}[A-Z]{6}[0-9LMNPQRSTU]{2}[A-Z]{1}[0-9LMNPQRSTU]{2}[A-Z]{1}[0-9LMNPQRSTU]{3}[A-Z]{1}</td> </tr> </tbody> </table>	Kind	Value	pattern	[0-9]{11}[A-Z]{6}[0-9LMNPQRSTU]{2}[A-Z]{1}[0-9LMNPQRSTU]{2}[A-Z]{1}[0-9LMNPQRSTU]{3}[A-Z]{1}
Kind	Value				
pattern	[0-9]{11}[A-Z]{6}[0-9LMNPQRSTU]{2}[A-Z]{1}[0-9LMNPQRSTU]{2}[A-Z]{1}[0-9LMNPQRSTU]{3}[A-Z]{1}				

element Dati_Primo_Figlio_Type/Mesi

diagram																													
namespace	urn:www.agenziaentrate.gov.it:specificheTecniche:sco:p73																												
type	p73:Mesi_Type																												
facets	<table border="1"> <thead> <tr> <th>Kind</th> <th>Value</th> </tr> </thead> <tbody> <tr> <td>pattern</td> <td>[1-9]{1}[0-9]*</td> </tr> <tr> <td>enumeration</td> <td>1</td> </tr> <tr> <td>enumeration</td> <td>2</td> </tr> <tr> <td>enumeration</td> <td>3</td> </tr> <tr> <td>enumeration</td> <td>4</td> </tr> <tr> <td>enumeration</td> <td>5</td> </tr> <tr> <td>enumeration</td> <td>6</td> </tr> <tr> <td>enumeration</td> <td>7</td> </tr> <tr> <td>enumeration</td> <td>8</td> </tr> <tr> <td>enumeration</td> <td>9</td> </tr> <tr> <td>enumeration</td> <td>10</td> </tr> <tr> <td>enumeration</td> <td>11</td> </tr> <tr> <td>enumeration</td> <td>12</td> </tr> </tbody> </table>	Kind	Value	pattern	[1-9]{1}[0-9]*	enumeration	1	enumeration	2	enumeration	3	enumeration	4	enumeration	5	enumeration	6	enumeration	7	enumeration	8	enumeration	9	enumeration	10	enumeration	11	enumeration	12
Kind	Value																												
pattern	[1-9]{1}[0-9]*																												
enumeration	1																												
enumeration	2																												
enumeration	3																												
enumeration	4																												
enumeration	5																												
enumeration	6																												
enumeration	7																												
enumeration	8																												
enumeration	9																												
enumeration	10																												
enumeration	11																												
enumeration	12																												

element Dati_Primo_Figlio_Type/MesiMinore

diagram																													
namespace	urn:www.agenziaentrate.gov.it:specificheTecniche:sco:p73																												
type	p73:Mesi_Type																												
facets	<table border="1"> <thead> <tr> <th>Kind</th> <th>Value</th> </tr> </thead> <tbody> <tr> <td>pattern</td> <td>[1-9]{1}[0-9]*</td> </tr> <tr> <td>enumeration</td> <td>1</td> </tr> <tr> <td>enumeration</td> <td>2</td> </tr> <tr> <td>enumeration</td> <td>3</td> </tr> <tr> <td>enumeration</td> <td>4</td> </tr> <tr> <td>enumeration</td> <td>5</td> </tr> <tr> <td>enumeration</td> <td>6</td> </tr> <tr> <td>enumeration</td> <td>7</td> </tr> <tr> <td>enumeration</td> <td>8</td> </tr> <tr> <td>enumeration</td> <td>9</td> </tr> <tr> <td>enumeration</td> <td>10</td> </tr> <tr> <td>enumeration</td> <td>11</td> </tr> <tr> <td>enumeration</td> <td>12</td> </tr> </tbody> </table>	Kind	Value	pattern	[1-9]{1}[0-9]*	enumeration	1	enumeration	2	enumeration	3	enumeration	4	enumeration	5	enumeration	6	enumeration	7	enumeration	8	enumeration	9	enumeration	10	enumeration	11	enumeration	12
Kind	Value																												
pattern	[1-9]{1}[0-9]*																												
enumeration	1																												
enumeration	2																												
enumeration	3																												
enumeration	4																												
enumeration	5																												
enumeration	6																												
enumeration	7																												
enumeration	8																												
enumeration	9																												
enumeration	10																												
enumeration	11																												
enumeration	12																												

element Dati_Primo_Figlio_Type/PercDetraz

diagram					
namespace	urn:www.agenziaentrate.gov.it:specificheTecniche:sco:p73				
type	DatoPC_Type				
facets	<table border="1"> <tr> <th>Kind</th> <th>Value</th> </tr> <tr> <td>pattern</td> <td>[0-9]?[0-9](, d{1,3})? 100,0{1,3}?</td> </tr> </table>	Kind	Value	pattern	[0-9]?[0-9](, d{1,3})? 100,0{1,3}?
Kind	Value				
pattern	[0-9]?[0-9](, d{1,3})? 100,0{1,3}?				

element Dati_Primo_Figlio_Type/Affidamento

diagram					
namespace	urn:www.agenziaentrate.gov.it:specificheTecniche:sco:p73				
type	DatoCB_Type				
facets	<table border="1"> <tr> <th>Kind</th> <th>Value</th> </tr> <tr> <td>pattern</td> <td>[01]</td> </tr> </table>	Kind	Value	pattern	[01]
Kind	Value				
pattern	[01]				

complexType Dati_Registrazione_Accatamento_Recupero_Patrimonio_Edilizio_Type

diagram	
namespace	urn:www.agenziaentrate.gov.it:specificheTecniche:sco:p73
children	p73:NOrdImmibile p73:Condominio p73:EstremiRegistrazioneContratto p73:DomandaAccatamento

element Dati_Registrazione_Accatamento_Recupero_Patrimonio_Edilizio_Type/NOrdImmibile

diagram					
namespace	urn:www.agenziaentrate.gov.it:specificheTecniche:sco:p73				
type	DatoNP_Type				
facets	<table border="1"> <tr> <th>Kind</th> <th>Value</th> </tr> <tr> <td>pattern</td> <td>[1-9]{1}[0-9]*</td> </tr> </table>	Kind	Value	pattern	[1-9]{1}[0-9]*
Kind	Value				
pattern	[1-9]{1}[0-9]*				

element Dati_Registrazione_Accatamento_Recupero_Patrimonio_Edilizio_Type/Condominio

diagram	
namespace	urn:www.agenziaentrate.gov.it:specificheTecniche:sco:p73

type	DatoCB_Type	
facets	Kind	Value
	pattern	[01]

element

Dati_Registrazione_Accatamento_Recupero_Patrimonio_Edilizio_Type/EstremiRegistrazioneContratto

diagram		
namespace	urn:www.agenziaentrate.gov.it:specificheTecniche:sco:p73	
type	p73:Dati_Contratto_Type	
children	p73:DataRegContratto p73:SerieContratto p73:NumeroContratto p73:Sottonumero p73:CodiceUfficio p73:IdentificativoContratto	

element

Dati_Registrazione_Accatamento_Recupero_Patrimonio_Edilizio_Type/DomandaAccatamento

diagram		
namespace	urn:www.agenziaentrate.gov.it:specificheTecniche:sco:p73	
type	p73:Domanda_Accatamento_Type	
children	p73:Data p73:Numero p73:ProvinciaUfficio	

complexType Debito_Type

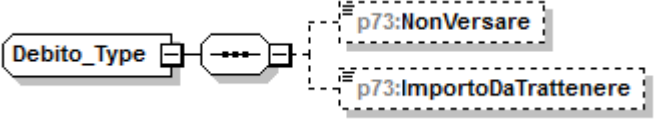
diagram	
namespace	urn:www.agenziaentrate.gov.it:specificheTecniche:sco:p73
children	p73:NonVersare p73:ImportoDaTrattenere

element Debito_Type/NonVersare

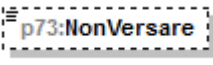
diagram					
namespace	urn:www.agenziaentrate.gov.it:specificheTecniche:sco:p73				
type	DatoNP_Type				
facets	<table border="1"> <tr> <th>Kind</th> <th>Value</th> </tr> <tr> <td>pattern</td> <td>[1-9]{1}[0-9]*</td> </tr> </table>	Kind	Value	pattern	[1-9]{1}[0-9]*
Kind	Value				
pattern	[1-9]{1}[0-9]*				

element Debito_Type/ImportoDaTrattenere

diagram					
namespace	urn:www.agenziaentrate.gov.it:specificheTecniche:sco:p73				
type	DatoNP_Type				
facets	<table border="1"> <tr> <th>Kind</th> <th>Value</th> </tr> <tr> <td>pattern</td> <td>[1-9]{1}[0-9]*</td> </tr> </table>	Kind	Value	pattern	[1-9]{1}[0-9]*
Kind	Value				
pattern	[1-9]{1}[0-9]*				

complexType Deduzioni_Modulo_Type

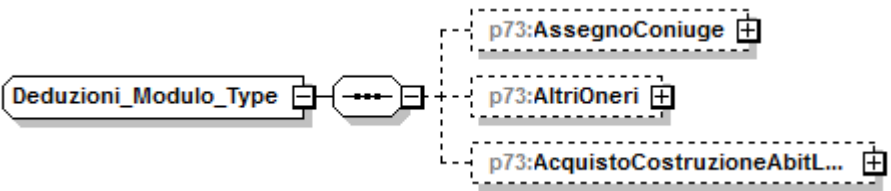
diagram	
namespace	urn:www.agenziaentrate.gov.it:specificheTecniche:sco:p73
children	p73:AssegnoConiuge p73:AltriOneri p73:AcquistoCostruzioneAbitLocazione

element **Deduzioni_Modulo_Type/AssegnoConiuge**

diagram	
namespace	urn:www.agenziaentrate.gov.it:specificheTecniche:sco:p73
type	p73:Assegno_Coniuge_Type
children	p73:CodiceFiscale p73:Importo

element **Deduzioni_Modulo_Type/AltriOneri**

diagram	
namespace	urn:www.agenziaentrate.gov.it:specificheTecniche:sco:p73
type	p73:Altri_Oneri_Type
children	p73:Codice p73:Importo

element **Deduzioni_Modulo_Type/AcquistoCostruzioneAbitLocazione**

diagram	
namespace	urn:www.agenziaentrate.gov.it:specificheTecniche:sco:p73
type	p73:Acquisto_Costruzione_Abit_Locazione
children	p73:DataStipula p73:Spesa p73:InteressiMutuo

complexType **Deduzioni_Type**

<p>diagram</p>	
<p>namespace</p>	<p>urn:www.agenziaentrate.gov.it:specificheTecniche:sco:p73</p>
<p>children</p>	<p>p73:ContributiPrevAss p73:AssegnoConiuge p73:ContributiColf p73:ErogazioniIstituzioniReligiose p73:SpesePortatoriHandicap p73:AltriOneri p73:DeducibilitaOrdinaria p73:LavoratoriPrimaOccupazione p73:FondiInSquilibrioFinanziario p73:FamiliariACarico p73:FondoPensioneDipendentiPubblici p73:AcquistoCostruzioneAbitLCoazione p73:RestituzioneSomme</p>

element **Deduzioni_Type/ContributiPrevAss**

<p>diagram</p>					
<p>namespace</p>	<p>urn:www.agenziaentrate.gov.it:specificheTecniche:sco:p73</p>				
<p>type</p>	<p>DatoNP_Type</p>				
<p>facets</p>	<table border="1"> <thead> <tr> <th>Kind</th> <th>Value</th> </tr> </thead> <tbody> <tr> <td>pattern</td> <td>[1-9]{1}[0-9]*</td> </tr> </tbody> </table>	Kind	Value	pattern	[1-9]{1}[0-9]*
Kind	Value				
pattern	[1-9]{1}[0-9]*				

element Deduzioni_Type/AssegnoConiuge

diagram	
namespace	urn:www.agenziaentrate.gov.it:specificheTecniche:sco:p73
type	p73:Assegno_Coniuge_Type
children	p73:CodiceFiscale p73:Importo

element Deduzioni_Type/ContributiColf

diagram					
namespace	urn:www.agenziaentrate.gov.it:specificheTecniche:sco:p73				
type	DatoNP_Type				
facets	<table border="0"> <tr> <td>Kind</td> <td>Value</td> </tr> <tr> <td>pattern</td> <td>[1-9]{1}[0-9]*</td> </tr> </table>	Kind	Value	pattern	[1-9]{1}[0-9]*
Kind	Value				
pattern	[1-9]{1}[0-9]*				

element Deduzioni_Type/ErogazioniIstituzioniReligiose

diagram					
namespace	urn:www.agenziaentrate.gov.it:specificheTecniche:sco:p73				
type	DatoNP_Type				
facets	<table border="0"> <tr> <td>Kind</td> <td>Value</td> </tr> <tr> <td>pattern</td> <td>[1-9]{1}[0-9]*</td> </tr> </table>	Kind	Value	pattern	[1-9]{1}[0-9]*
Kind	Value				
pattern	[1-9]{1}[0-9]*				

element Deduzioni_Type/SpesePortatoriHandicap

diagram					
namespace	urn:www.agenziaentrate.gov.it:specificheTecniche:sco:p73				
type	DatoNP_Type				
facets	<table border="0"> <tr> <td>Kind</td> <td>Value</td> </tr> <tr> <td>pattern</td> <td>[1-9]{1}[0-9]*</td> </tr> </table>	Kind	Value	pattern	[1-9]{1}[0-9]*
Kind	Value				
pattern	[1-9]{1}[0-9]*				

element **Deduzioni_Type/AltriOneri**

diagram	<p>The diagram shows a dashed box labeled 'p73:AltriOneri' connected to a central octagonal connector. This connector is linked to a larger dashed box labeled 'p73:Altri_Oneri_Type'. Inside this box are two smaller dashed boxes: 'p73:Codice' and 'p73:Importo'.</p>
namespace	urn:www.agenziaentrate.gov.it:specificheTecniche:sco:p73
type	p73:Altri_Oneri_Type
children	p73:Codice p73:Importo

element **Deduzioni_Type/DeducibilitaOrdinaria**

diagram	<p>The diagram shows a dashed box labeled 'p73:DeducibilitaOrdinaria' connected to a central octagonal connector. This connector is linked to a larger dashed box labeled 'p73:Contributi_Previdenza_Complementare_Type'. Inside this box are two smaller dashed boxes: 'p73:EsclusiDalSostituto' and 'p73:NonEsclusiDalSostituto'.</p>
namespace	urn:www.agenziaentrate.gov.it:specificheTecniche:sco:p73
type	p73:Contributi_Previdenza_Complementare_Type
children	p73:EsclusiDalSostituto p73:NonEsclusiDalSostituto

element **Deduzioni_Type/LavoratoriPrimaOccupazione**

diagram	<p>The diagram shows a dashed box labeled 'p73:LavoratoriPrimaOccupazione' connected to a central octagonal connector. This connector is linked to a larger dashed box labeled 'p73:Contributi_Previdenza_Complementare_Type'. Inside this box are two smaller dashed boxes: 'p73:EsclusiDalSostituto' and 'p73:NonEsclusiDalSostituto'.</p>
namespace	urn:www.agenziaentrate.gov.it:specificheTecniche:sco:p73
type	p73:Contributi_Previdenza_Complementare_Type
children	p73:EsclusiDalSostituto p73:NonEsclusiDalSostituto

element **Deduzioni_Type/FondiInSquilibrioFinanziario**

diagram	<p>The diagram shows a class <code>p73:FondiInSquilibrioFinanziario</code> (dashed box) associated with a class <code>p73:Contributi_Previdenza_Complementare_Type</code> (solid box). The association is bidirectional. Inside <code>p73:Contributi_Previdenza_Complementare_Type</code>, there are two subclasses: <code>p73:EsclusiDalSostituto</code> and <code>p73:NonEsclusiDalSostituto</code>, both shown in dashed boxes.</p>
namespace	urn:www.agenziaentrate.gov.it:specificheTecniche:sco:p73
type	p73:Contributi_Previdenza_Complementare_Type
children	p73:EsclusiDalSostituto p73:NonEsclusiDalSostituto

element **Deduzioni_Type/FamiliariACarico**

diagram	<p>The diagram shows a class <code>p73:FamiliariACarico</code> (dashed box) associated with a class <code>p73:Contributi_Previdenza_Complementare_Type</code> (solid box). The association is bidirectional. Inside <code>p73:Contributi_Previdenza_Complementare_Type</code>, there are two subclasses: <code>p73:EsclusiDalSostituto</code> and <code>p73:NonEsclusiDalSostituto</code>, both shown in dashed boxes.</p>
namespace	urn:www.agenziaentrate.gov.it:specificheTecniche:sco:p73
type	p73:Contributi_Previdenza_Complementare_Type
children	p73:EsclusiDalSostituto p73:NonEsclusiDalSostituto

element **Deduzioni_Type/FondoPensioneDipendentiPubblici**

diagram	<p>The diagram shows a class <code>p73:FondoPensioneDipendenti...</code> (dashed box) associated with a class <code>p73:Fondo_Pensione_Dipendenti_Pubblici_Type</code> (solid box). The association is bidirectional. Inside <code>p73:Fondo_Pensione_Dipendenti_Pubblici_Type</code>, there are two subclasses: <code>p73:Contributi</code> and <code>p73:QuotaTFR</code>, both shown in dashed boxes.</p>
namespace	urn:www.agenziaentrate.gov.it:specificheTecniche:sco:p73
type	p73:Fondo_Pensione_Dipendenti_Pubblici_Type
children	p73:Contributi p73:QuotaTFR

element **Deduzioni_Type/AcquistoCostruzioneAbitLocazione**

diagram	
namespace	urn:www.agenziaentrate.gov.it:specificheTecniche:sco:p73
type	p73:Acquisto_Costruzione_Abit_Locazione
children	p73:DataStipula p73:Spesa p73:InteressiMutuo

element **Deduzioni_Type/RestituzioneSomme**

diagram	
namespace	urn:www.agenziaentrate.gov.it:specificheTecniche:sco:p73
type	p73:Restituzione_Somme_Type
children	p73:SommeRestituite p73:ResiduoPrecedenteDic

complexType **Detrazione_Crediti_Type**

<p>diagram</p>	
<p>namespace</p>	<p>urn:www.agenziaentrate.gov.it:specificheTecniche:sco:p73</p>
<p>children</p>	<p>p73:DetrazioneConiuge p73:DetrazioneFigli p73:UlterioreDetrazioneFigli p73:DetrazioneFamiliari p73:DetrazioneLavDip p73:DetrazionePens p73:DetrazioneAltriRedditi p73:DetrazioneOneri p73:DetrazioneRistrutturazione p73:DetrazioniArredolmmobili p73:DetrazioneRisparmioEnergetico p73:DetrazioneArredoGiovaniCoppie p73:DetrazionelvaAcquistoAbitaz p73:DetrazioneLocEAgricoliGiovani p73:AltreDetrazioni p73:CreditoPrimaCasa p73:CreditoOccupazione p73:CreditoFondiPensione p73:CreditoMediazioni p73:CreditoNegoziazione p73:TotaleDetrazioniCrediti</p>

element Detrazione_Crediti_Type/DetrazioneConiuge

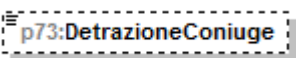
diagram					
namespace	urn:www.agenziaentrate.gov.it:specificheTecniche:sco:p73				
type	DatoNP_Type				
facets	<table border="1"> <tr> <td>Kind</td> <td>Value</td> </tr> <tr> <td>pattern</td> <td>[1-9]{1}[0-9]*</td> </tr> </table>	Kind	Value	pattern	[1-9]{1}[0-9]*
Kind	Value				
pattern	[1-9]{1}[0-9]*				

element Detrazione_Crediti_Type/DetrazioneFigli

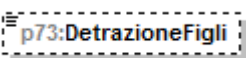
diagram					
namespace	urn:www.agenziaentrate.gov.it:specificheTecniche:sco:p73				
type	DatoNP_Type				
facets	<table border="1"> <tr> <td>Kind</td> <td>Value</td> </tr> <tr> <td>pattern</td> <td>[1-9]{1}[0-9]*</td> </tr> </table>	Kind	Value	pattern	[1-9]{1}[0-9]*
Kind	Value				
pattern	[1-9]{1}[0-9]*				

element Detrazione_Crediti_Type/UlterioreDetrazioneFigli

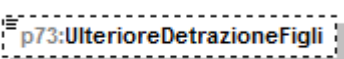
diagram					
namespace	urn:www.agenziaentrate.gov.it:specificheTecniche:sco:p73				
type	DatoNP_Type				
facets	<table border="1"> <tr> <td>Kind</td> <td>Value</td> </tr> <tr> <td>pattern</td> <td>[1-9]{1}[0-9]*</td> </tr> </table>	Kind	Value	pattern	[1-9]{1}[0-9]*
Kind	Value				
pattern	[1-9]{1}[0-9]*				

element Detrazione_Crediti_Type/DetrazioneFamiliari

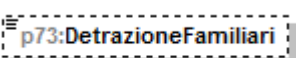
diagram					
namespace	urn:www.agenziaentrate.gov.it:specificheTecniche:sco:p73				
type	DatoNP_Type				
facets	<table border="1"> <tr> <td>Kind</td> <td>Value</td> </tr> <tr> <td>pattern</td> <td>[1-9]{1}[0-9]*</td> </tr> </table>	Kind	Value	pattern	[1-9]{1}[0-9]*
Kind	Value				
pattern	[1-9]{1}[0-9]*				

element Detrazione_Crediti_Type/DetrazioneLavDip

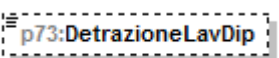
diagram					
namespace	urn:www.agenziaentrate.gov.it:specificheTecniche:sco:p73				
type	DatoNP_Type				
facets	<table border="1"> <tr> <td>Kind</td> <td>Value</td> </tr> <tr> <td>pattern</td> <td>[1-9]{1}[0-9]*</td> </tr> </table>	Kind	Value	pattern	[1-9]{1}[0-9]*
Kind	Value				
pattern	[1-9]{1}[0-9]*				

element **Detrazione_Crediti_Type/DetrazionePens**

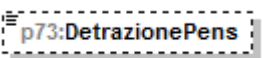
diagram					
namespace	urn:www.agenziaentrate.gov.it:specificheTecniche:sco:p73				
type	DatoNP_Type				
facets	<table border="1"> <tr> <td>Kind</td> <td>Value</td> </tr> <tr> <td>pattern</td> <td>[1-9]{1}[0-9]*</td> </tr> </table>	Kind	Value	pattern	[1-9]{1}[0-9]*
Kind	Value				
pattern	[1-9]{1}[0-9]*				

element **Detrazione_Crediti_Type/DetrazioneAltriRedditi**

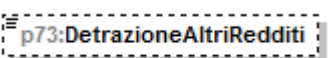
diagram					
namespace	urn:www.agenziaentrate.gov.it:specificheTecniche:sco:p73				
type	DatoNP_Type				
facets	<table border="1"> <tr> <td>Kind</td> <td>Value</td> </tr> <tr> <td>pattern</td> <td>[1-9]{1}[0-9]*</td> </tr> </table>	Kind	Value	pattern	[1-9]{1}[0-9]*
Kind	Value				
pattern	[1-9]{1}[0-9]*				

element **Detrazione_Crediti_Type/DetrazioneOneri**

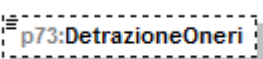
diagram					
namespace	urn:www.agenziaentrate.gov.it:specificheTecniche:sco:p73				
type	DatoNP_Type				
facets	<table border="1"> <tr> <td>Kind</td> <td>Value</td> </tr> <tr> <td>pattern</td> <td>[1-9]{1}[0-9]*</td> </tr> </table>	Kind	Value	pattern	[1-9]{1}[0-9]*
Kind	Value				
pattern	[1-9]{1}[0-9]*				

element **Detrazione_Crediti_Type/DetrazioneRistrutturazione**

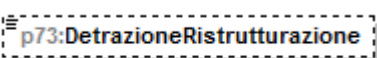
diagram					
namespace	urn:www.agenziaentrate.gov.it:specificheTecniche:sco:p73				
type	DatoNP_Type				
facets	<table border="1"> <tr> <td>Kind</td> <td>Value</td> </tr> <tr> <td>pattern</td> <td>[1-9]{1}[0-9]*</td> </tr> </table>	Kind	Value	pattern	[1-9]{1}[0-9]*
Kind	Value				
pattern	[1-9]{1}[0-9]*				

element **Detrazione_Crediti_Type/DetrazioniArredolmmobili**

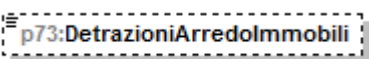
diagram					
namespace	urn:www.agenziaentrate.gov.it:specificheTecniche:sco:p73				
type	DatoNP_Type				
facets	<table border="1"> <tr> <td>Kind</td> <td>Value</td> </tr> <tr> <td>pattern</td> <td>[1-9]{1}[0-9]*</td> </tr> </table>	Kind	Value	pattern	[1-9]{1}[0-9]*
Kind	Value				
pattern	[1-9]{1}[0-9]*				

element Detrazione_Crediti_Type/DetrazioneRisparmioEnergetico

diagram					
namespace	urn:www.agenziaentrate.gov.it:specificheTecniche:sco:p73				
type	DatoNP_Type				
facets	<table border="1"> <tr> <td>Kind</td> <td>Value</td> </tr> <tr> <td>pattern</td> <td>[1-9]{1}[0-9]*</td> </tr> </table>	Kind	Value	pattern	[1-9]{1}[0-9]*
Kind	Value				
pattern	[1-9]{1}[0-9]*				

element Detrazione_Crediti_Type/DetrazioneArredoGiovaniCoppie

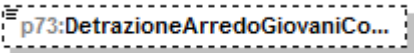
diagram					
namespace	urn:www.agenziaentrate.gov.it:specificheTecniche:sco:p73				
type	DatoNP_Type				
facets	<table border="1"> <tr> <td>Kind</td> <td>Value</td> </tr> <tr> <td>pattern</td> <td>[1-9]{1}[0-9]*</td> </tr> </table>	Kind	Value	pattern	[1-9]{1}[0-9]*
Kind	Value				
pattern	[1-9]{1}[0-9]*				

element Detrazione_Crediti_Type/DetrazioneIvaAcquistoAbitaz

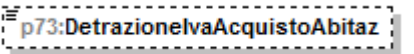
diagram					
namespace	urn:www.agenziaentrate.gov.it:specificheTecniche:sco:p73				
type	DatoNP_Type				
facets	<table border="1"> <tr> <td>Kind</td> <td>Value</td> </tr> <tr> <td>pattern</td> <td>[1-9]{1}[0-9]*</td> </tr> </table>	Kind	Value	pattern	[1-9]{1}[0-9]*
Kind	Value				
pattern	[1-9]{1}[0-9]*				

element Detrazione_Crediti_Type/DetrazioneLocEAgricoliGiovani

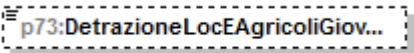
diagram					
namespace	urn:www.agenziaentrate.gov.it:specificheTecniche:sco:p73				
type	DatoNP_Type				
facets	<table border="1"> <tr> <td>Kind</td> <td>Value</td> </tr> <tr> <td>pattern</td> <td>[1-9]{1}[0-9]*</td> </tr> </table>	Kind	Value	pattern	[1-9]{1}[0-9]*
Kind	Value				
pattern	[1-9]{1}[0-9]*				

element Detrazione_Crediti_Type/AltreDetrazioni

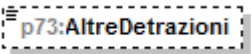
diagram					
namespace	urn:www.agenziaentrate.gov.it:specificheTecniche:sco:p73				
type	DatoNP_Type				
facets	<table border="1"> <tr> <td>Kind</td> <td>Value</td> </tr> <tr> <td>pattern</td> <td>[1-9]{1}[0-9]*</td> </tr> </table>	Kind	Value	pattern	[1-9]{1}[0-9]*
Kind	Value				
pattern	[1-9]{1}[0-9]*				

element Detrazione_Crediti_Type/CreditoPrimaCasa

diagram					
namespace	urn:www.agenziaentrate.gov.it:specificheTecniche:sco:p73				
type	DatoNP_Type				
facets	<table border="1"> <tr> <td>Kind</td> <td>Value</td> </tr> <tr> <td>pattern</td> <td>[1-9]{1}[0-9]*</td> </tr> </table>	Kind	Value	pattern	[1-9]{1}[0-9]*
Kind	Value				
pattern	[1-9]{1}[0-9]*				

element Detrazione_Crediti_Type/CreditoOccupazione

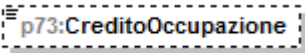
diagram					
namespace	urn:www.agenziaentrate.gov.it:specificheTecniche:sco:p73				
type	DatoNP_Type				
facets	<table border="1"> <tr> <td>Kind</td> <td>Value</td> </tr> <tr> <td>pattern</td> <td>[1-9]{1}[0-9]*</td> </tr> </table>	Kind	Value	pattern	[1-9]{1}[0-9]*
Kind	Value				
pattern	[1-9]{1}[0-9]*				

element Detrazione_Crediti_Type/CreditoFondiPensione

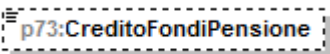
diagram					
namespace	urn:www.agenziaentrate.gov.it:specificheTecniche:sco:p73				
type	DatoNP_Type				
facets	<table border="1"> <tr> <td>Kind</td> <td>Value</td> </tr> <tr> <td>pattern</td> <td>[1-9]{1}[0-9]*</td> </tr> </table>	Kind	Value	pattern	[1-9]{1}[0-9]*
Kind	Value				
pattern	[1-9]{1}[0-9]*				

element Detrazione_Crediti_Type/CreditoMediazioni

diagram					
namespace	urn:www.agenziaentrate.gov.it:specificheTecniche:sco:p73				
type	DatoNP_Type				
facets	<table border="1"> <tr> <td>Kind</td> <td>Value</td> </tr> <tr> <td>pattern</td> <td>[1-9]{1}[0-9]*</td> </tr> </table>	Kind	Value	pattern	[1-9]{1}[0-9]*
Kind	Value				
pattern	[1-9]{1}[0-9]*				

element Detrazione_Crediti_Type/CreditoNegoziazione

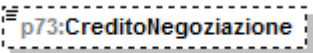
diagram					
namespace	urn:www.agenziaentrate.gov.it:specificheTecniche:sco:p73				
type	DatoNP_Type				
facets	<table border="1"> <tr> <td>Kind</td> <td>Value</td> </tr> <tr> <td>pattern</td> <td>[1-9]{1}[0-9]*</td> </tr> </table>	Kind	Value	pattern	[1-9]{1}[0-9]*
Kind	Value				
pattern	[1-9]{1}[0-9]*				

element **Detrazione_Crediti_Type/TotaleDetrazioniCrediti**

diagram					
namespace	urn:www.agenziaentrate.gov.it:specificheTecniche:sco:p73				
type	DatoNP_Type				
facets	<table border="1"> <tr> <td>Kind</td> <td>Value</td> </tr> <tr> <td>pattern</td> <td>[1-9]{1}[0-9]*</td> </tr> </table>	Kind	Value	pattern	[1-9]{1}[0-9]*
Kind	Value				
pattern	[1-9]{1}[0-9]*				

complexType **Detrazioni_Canoni_Locazione_Type**

diagram	
namespace	urn:www.agenziaentrate.gov.it:specificheTecniche:sco:p73
children	p73:InquiliniAbitazionePrincipale p73:DipendentiTrasferiti

element **Detrazioni_Canoni_Locazione_Type/InquiliniAbitazionePrincipale**

diagram	
namespace	urn:www.agenziaentrate.gov.it:specificheTecniche:sco:p73
type	p73:Inquilini_Abitazione_Principale_Type
children	p73:Tipologia p73:GiorniPercentuale

element **Detrazioni_Canoni_Locazione_Type/DipendentiTrasferiti**

diagram	
namespace	urn:www.agenziaentrate.gov.it:specificheTecniche:sco:p73
type	p73:Giorni_Percentuale_Type
children	p73:Giorni p73:Percentuale

complexType Detrazioni_Modulo_Type

<p>diagram</p>	
<p>namespace</p>	<p>urn:www.agenziaentrate.gov.it:specificheTecniche:sco:p73</p>
<p>children</p>	<p>p73:VeicoliDisabili p73:AcquistoCaniGuida p73:SpeseRateizzate p73:AltreSpese p73:SpeseLeasing</p>

element Detrazioni_Modulo_Type/VeicoliDisabili

<p>diagram</p>	
<p>namespace</p>	<p>urn:www.agenziaentrate.gov.it:specificheTecniche:sco:p73</p>
<p>type</p>	<p>p73:Spese_Rateizzate_Type</p>
<p>children</p>	<p>p73:Codice p73:Importo</p>

element Detrazioni_Modulo_Type/AcquistoCaniGuida

<p>diagram</p>	
<p>namespace</p>	<p>urn:www.agenziaentrate.gov.it:specificheTecniche:sco:p73</p>
<p>type</p>	<p>p73:Spese_Rateizzate_Type</p>
<p>children</p>	<p>p73:Codice p73:Importo</p>

element Detrazioni_Modulo_Type/SpeseRateizzate

diagram	
namespace	urn:www.agenziaentrate.gov.it:specificheTecniche:sco:p73
type	p73:Spese_Rateizzate_Anni_Precedenti_Type
children	p73:Codice p73:Importo

element Detrazioni_Modulo_Type/AltreSpese

diagram	
namespace	urn:www.agenziaentrate.gov.it:specificheTecniche:sco:p73
type	p73:Altre_Spese_Type
children	p73:Codice p73:Importo

element Detrazioni_Modulo_Type/SpeseLeasing

diagram	
namespace	urn:www.agenziaentrate.gov.it:specificheTecniche:sco:p73
type	p73:Spese_Leasing_Type
children	p73:DataStipula p73:NumeroAnno p73:Canone p73:PrezzoRiscatto

complexType **Detrazioni_Type**

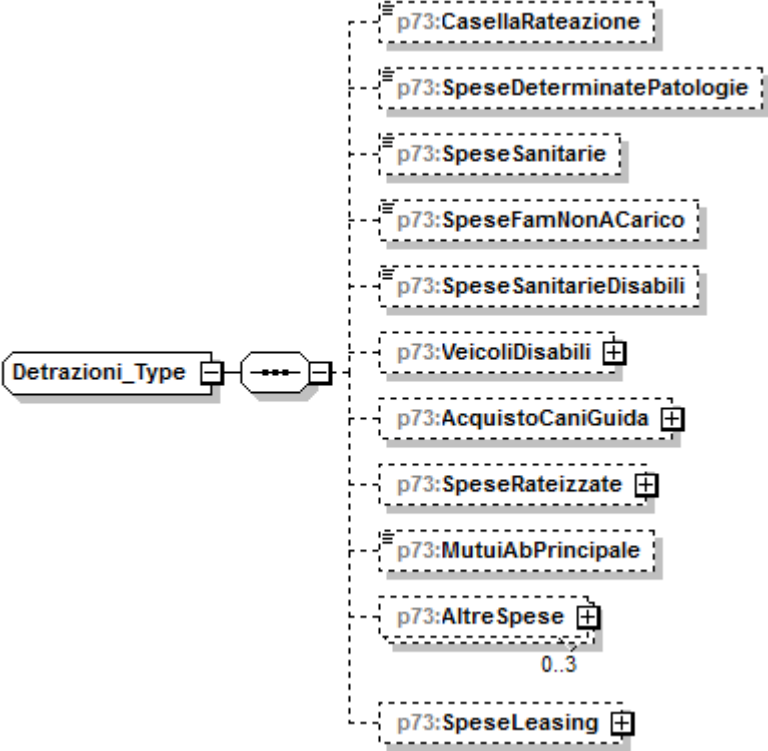
<p>diagram</p>	
<p>namespace</p>	<p>urn:www.agenziaentrate.gov.it:specificheTecniche:sco:p73</p>
<p>children</p>	<p>p73:CasellaRateazione p73:SpeseDeterminatePatologie p73:SpeseSanitarie p73:SpeseFamNonACarico p73:SpeseSanitarieDisabili p73:VeicoliDisabili p73:AcquistoCaniGuida p73:SpeseRateizzate p73:MutuiAbPrincipale p73:AltreSpese p73:SpeseLeasing</p>

element **Detrazioni_Type/CasellaRateazione**

<p>diagram</p>					
<p>namespace</p>	<p>urn:www.agenziaentrate.gov.it:specificheTecniche:sco:p73</p>				
<p>type</p>	<p>DatoCB_Type</p>				
<p>facets</p>	<table border="1"> <tr> <td>Kind</td> <td>Value</td> </tr> <tr> <td>pattern</td> <td>[01]</td> </tr> </table>	Kind	Value	pattern	[01]
Kind	Value				
pattern	[01]				

element **Detrazioni_Type/SpeseDeterminatePatologie**

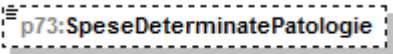
<p>diagram</p>					
<p>namespace</p>	<p>urn:www.agenziaentrate.gov.it:specificheTecniche:sco:p73</p>				
<p>type</p>	<p>DatoNP_Type</p>				
<p>facets</p>	<table border="1"> <tr> <td>Kind</td> <td>Value</td> </tr> <tr> <td>pattern</td> <td>[1-9]{1}[0-9]*</td> </tr> </table>	Kind	Value	pattern	[1-9]{1}[0-9]*
Kind	Value				
pattern	[1-9]{1}[0-9]*				

element Detrazioni_Type/SpeseSanitarie

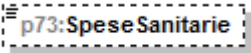
diagram					
namespace	urn:www.agenziaentrate.gov.it:specificheTecniche:sco:p73				
type	DatoNP_Type				
facets	<table border="1"> <tr> <td>Kind</td> <td>Value</td> </tr> <tr> <td>pattern</td> <td>[1-9]{1}[0-9]*</td> </tr> </table>	Kind	Value	pattern	[1-9]{1}[0-9]*
Kind	Value				
pattern	[1-9]{1}[0-9]*				

element Detrazioni_Type/SpeseFamNonACarico

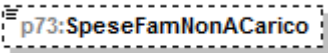
diagram					
namespace	urn:www.agenziaentrate.gov.it:specificheTecniche:sco:p73				
type	DatoNP_Type				
facets	<table border="1"> <tr> <td>Kind</td> <td>Value</td> </tr> <tr> <td>pattern</td> <td>[1-9]{1}[0-9]*</td> </tr> </table>	Kind	Value	pattern	[1-9]{1}[0-9]*
Kind	Value				
pattern	[1-9]{1}[0-9]*				

element Detrazioni_Type/SpeseSanitarieDisabili

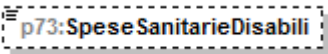
diagram					
namespace	urn:www.agenziaentrate.gov.it:specificheTecniche:sco:p73				
type	DatoNP_Type				
facets	<table border="1"> <tr> <td>Kind</td> <td>Value</td> </tr> <tr> <td>pattern</td> <td>[1-9]{1}[0-9]*</td> </tr> </table>	Kind	Value	pattern	[1-9]{1}[0-9]*
Kind	Value				
pattern	[1-9]{1}[0-9]*				

element Detrazioni_Type/VeicoliDisabili

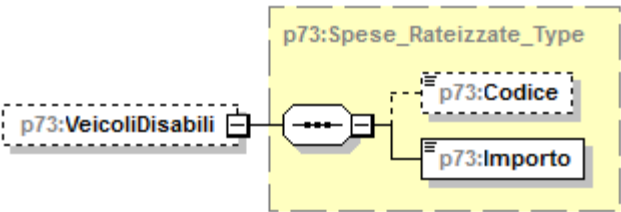
diagram	
namespace	urn:www.agenziaentrate.gov.it:specificheTecniche:sco:p73
type	p73:Spese_Rateizzate_Type
children	p73:Codice p73:Importo

element **Detrazioni_Type/AcquistoCaniGuida**

diagram	
namespace	urn:www.agenziaentrate.gov.it:specificheTecniche:sco:p73
type	p73:Spese_Rateizzate_Type
children	p73:Codice p73:Importo

element **Detrazioni_Type/SpeseRateizzate**

diagram	
namespace	urn:www.agenziaentrate.gov.it:specificheTecniche:sco:p73
type	p73:Spese_Rateizzate_Anni_Precedenti_Type
children	p73:Codice p73:Importo

element **Detrazioni_Type/MutuiAbPrincipale**

diagram					
namespace	urn:www.agenziaentrate.gov.it:specificheTecniche:sco:p73				
type	DatoNP_Type				
facets	<table border="1"> <thead> <tr> <th>Kind</th> <th>Value</th> </tr> </thead> <tbody> <tr> <td>pattern</td> <td>[1-9]{1}[0-9]*</td> </tr> </tbody> </table>	Kind	Value	pattern	[1-9]{1}[0-9]*
Kind	Value				
pattern	[1-9]{1}[0-9]*				

element **Detrazioni_Type/AltreSpese**

diagram	
namespace	urn:www.agenziaentrate.gov.it:specificheTecniche:sco:p73
type	p73:Altre_Spese_Type

children	p73:Codice p73:Importo
----------	--

element **Detrazioni_Type/SpeseLeasing**

diagram	
namespace	urn:www.agenziaentrate.gov.it:specificheTecniche:sco:p73
type	p73:Spese_Leasing_Type
children	p73:DataStipula p73:NumeroAnno p73:Canone p73:PrezzoRiscatto

complexType **Documento_P73_Type**

diagram	
namespace	urn:www.agenziaentrate.gov.it:specificheTecniche:sco:p73
children	p73:Frontespizio p73:DatiContabili p73:EsitiContabili

element **Documento_P73_Type/Frontespizio**

diagram	
namespace	urn:www.agenziaentrate.gov.it:specificheTecniche:sco:p73

type	p73:Frontespizio_730_Type
children	p73:SoggettoFiscale p73:DatiAnagrafici p73:DomicilioFiscaleSaldo p73:DomicilioFiscaleAcconto p73:CasiParticolariAddizionale

element **Documento_P73_Type/DatiContabili**

diagram	
namespace	urn:www.agenziaentrate.gov.it:specificheTecniche:sco:p73
type	p73:Dati_Contabili_Type
children	p73:Familiari p73:QuadroA p73:QuadroB p73:QuadroC p73:QuadroD p73:QuadroE p73:QuadroF p73:QuadroG p73:ProspettoLiquidazione

element **Documento_P73_Type/EsitiContabili**

diagram	
namespace	urn:www.agenziaentrate.gov.it:specificheTecniche:sco:p73
children	p73:Conguaglio

element **Documento_P73_Type/EsitiContabili/Conguaglio**

diagram	
namespace	urn:www.agenziaentrate.gov.it:specificheTecniche:sco:p73
type	p73:Conguaglio_Type
children	p73:NumeroRate p73:ImportoTrattenutoSaldo p73:ImportoTrattenutoAcconto p73:ImportoDaVersareF24Saldo p73:ImportoDaVersareF24Acconto p73:ImportoRimborsato p73:ImportoRimborsatoAgenzia p73:OpzioneInformativa

complexType **Domanda_Accatamento_Type**

diagram	
namespace	urn:www.agenziaentrate.gov.it:specificheTecniche:sco:p73
children	p73:Data p73:Numero p73:ProvinciaUfficio

element **Domanda_Accatamento_Type/Data**

diagram					
namespace	urn:www.agenziaentrate.gov.it:specificheTecniche:sco:p73				
type	DatoDT_Type				
facets	<table border="1"> <thead> <tr> <th>Kind</th> <th>Value</th> </tr> </thead> <tbody> <tr> <td>pattern</td> <td>((([0-9]{1,12}[0-9]{3,10})(0{1,3578} 10{1,2}(\d{4}))) ((([0-9]{1,12}[0-9]{30}(0{469} 11)(\d{4}))) ((([0-9]{1,10}[0-9]{2,8})(0{2}(\d{4}))) ((29)(02)([02468][048]00)) ((29)(02)([13579][26]00)) ((29)(02)([0-9][0-9][0][48])) ((29)(02)([0-9][0-9][2468][048])) ((29)(02)([0-9][0-9][13579][26]))))</td> </tr> </tbody> </table>	Kind	Value	pattern	((([0-9]{1,12}[0-9]{3,10})(0{1,3578} 10{1,2}(\d{4}))) ((([0-9]{1,12}[0-9]{30}(0{469} 11)(\d{4}))) ((([0-9]{1,10}[0-9]{2,8})(0{2}(\d{4}))) ((29)(02)([02468][048]00)) ((29)(02)([13579][26]00)) ((29)(02)([0-9][0-9][0][48])) ((29)(02)([0-9][0-9][2468][048])) ((29)(02)([0-9][0-9][13579][26]))))
Kind	Value				
pattern	((([0-9]{1,12}[0-9]{3,10})(0{1,3578} 10{1,2}(\d{4}))) ((([0-9]{1,12}[0-9]{30}(0{469} 11)(\d{4}))) ((([0-9]{1,10}[0-9]{2,8})(0{2}(\d{4}))) ((29)(02)([02468][048]00)) ((29)(02)([13579][26]00)) ((29)(02)([0-9][0-9][0][48])) ((29)(02)([0-9][0-9][2468][048])) ((29)(02)([0-9][0-9][13579][26]))))				

element Domanda_Accatastamento_Type/Numero

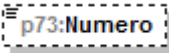
diagram	
namespace	urn:www.agenziaentrate.gov.it:specificheTecniche:sco:p73
type	DatoAN_Type
facets	Kind Value pattern ([0-9A-Z\-\-]"){1}([0-9A-Z&:] ' - \., / ° ^\(\\)\) À É È Ì Ò Ù Û " \\ \\ \\ +)*

element Domanda_Accatastamento_Type/ProvinciaUfficio

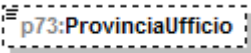
diagram	
namespace	urn:www.agenziaentrate.gov.it:specificheTecniche:sco:p73
type	PN_Type

complexType Domicilio_Fiscale_Aconto_Type

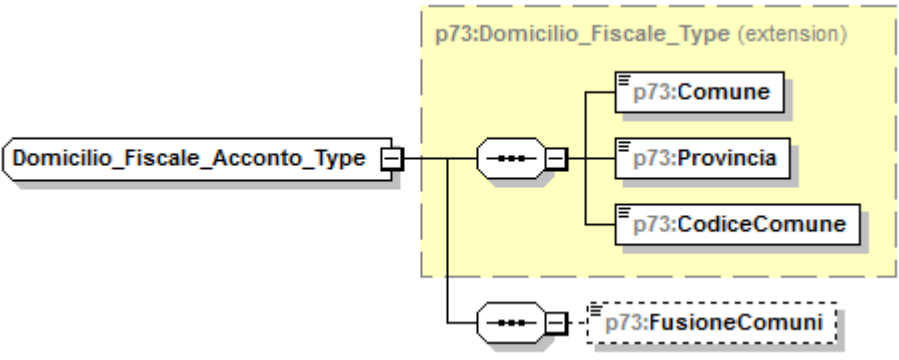
diagram	
namespace	urn:www.agenziaentrate.gov.it:specificheTecniche:sco:p73
type	extension of p73:Domicilio_Fiscale_Type
children	p73:Comune p73:Provincia p73:CodiceComune p73:FusioneComuni

element Domicilio_Fiscale_Aconto_Type/FusioneComuni

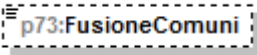
diagram	
namespace	urn:www.agenziaentrate.gov.it:specificheTecniche:sco:p73
type	DatoAN_Type
facets	Kind Value pattern ([0-9A-Z\-\-]"){1}([0-9A-Z&:] ' - \., / ° ^\(\\)\) À É È Ì Ò Ù Û " \\ \\ \\ +)*

complexType Domicilio_Fiscale_Type

diagram	
namespace	urn:www.agenziaentrate.gov.it:specificheTecniche:sco:p73
children	p73:Comune p73:Provincia p73:CodiceComune

element Domicilio_Fiscale_Type/Comune

diagram					
namespace	urn:www.agenziaentrate.gov.it:specificheTecniche:sco:p73				
type	DatoAN_Type				
facets	<table border="0"> <tr> <td>Kind</td> <td>Value</td> </tr> <tr> <td>pattern</td> <td>([0-9A-Z\-\-]*)&quot;}{1}([0-9A-Z&amp;:] ' - \., / ° '^\(\\)À È É Ì Ò Ù Û &quot; \\ /+)*</td> </tr> </table>	Kind	Value	pattern	([0-9A-Z\-\-]*)"}{1}([0-9A-Z&:] ' - \., / ° '^\(\\)À È É Ì Ò Ù Û " \\ /+)*
Kind	Value				
pattern	([0-9A-Z\-\-]*)"}{1}([0-9A-Z&:] ' - \., / ° '^\(\\)À È É Ì Ò Ù Û " \\ /+)*				

element Domicilio_Fiscale_Type/Provincia

diagram	
namespace	urn:www.agenziaentrate.gov.it:specificheTecniche:sco:p73
type	PR_Type

element Domicilio_Fiscale_Type/CodiceComune

diagram					
namespace	urn:www.agenziaentrate.gov.it:specificheTecniche:sco:p73				
type	DatoAN_Type				
facets	<table border="0"> <tr> <td>Kind</td> <td>Value</td> </tr> <tr> <td>pattern</td> <td>([0-9A-Z\-\-]*)&quot;}{1}([0-9A-Z&amp;:] ' - \., / ° '^\(\\)À È É Ì Ò Ù Û &quot; \\ /+)*</td> </tr> </table>	Kind	Value	pattern	([0-9A-Z\-\-]*)"}{1}([0-9A-Z&:] ' - \., / ° '^\(\\)À È É Ì Ò Ù Û " \\ /+)*
Kind	Value				
pattern	([0-9A-Z\-\-]*)"}{1}([0-9A-Z&:] ' - \., / ° '^\(\\)À È É Ì Ò Ù Û " \\ /+)*				

complexType **Eccedenze_Oltre_Anno_Type**

diagram	
namespace	urn:www.agenziaentrate.gov.it:specificheTecniche:sco:p73
children	p73:Anno p73:Irpef p73:SostitutivaQuadroRT p73:CedolareSecca p73:CodiceRegione p73:AddRegionaleIrpef p73:CodiceCatastaleComune p73:AddComunaleIrpef p73:ImpostaSostitutiva

element **Eccedenze_Oltre_Anno_Type/Anno**

diagram					
namespace	urn:www.agenziaentrate.gov.it:specificheTecniche:sco:p73				
type	DatoDA_Type				
facets	<table border="1"> <tr> <td>Kind</td> <td>Value</td> </tr> <tr> <td>pattern</td> <td>(18 19 20)[0-9]{2}</td> </tr> </table>	Kind	Value	pattern	(18 19 20)[0-9]{2}
Kind	Value				
pattern	(18 19 20)[0-9]{2}				

element **Eccedenze_Oltre_Anno_Type/Irpef**

diagram					
namespace	urn:www.agenziaentrate.gov.it:specificheTecniche:sco:p73				
type	DatoNP_Type				
facets	<table border="1"> <tr> <td>Kind</td> <td>Value</td> </tr> <tr> <td>pattern</td> <td>[1-9]{1}[0-9]*</td> </tr> </table>	Kind	Value	pattern	[1-9]{1}[0-9]*
Kind	Value				
pattern	[1-9]{1}[0-9]*				

element **Eccedenze_Oltre_Anno_Type/SostitutivaQuadroRT**

diagram	
namespace	urn:www.agenziaentrate.gov.it:specificheTecniche:sco:p73

type	DatoNP_Type				
facets	<table border="1"> <tr> <td>Kind</td> <td>Value</td> </tr> <tr> <td>pattern</td> <td>[1-9]{1}[0-9]*</td> </tr> </table>	Kind	Value	pattern	[1-9]{1}[0-9]*
Kind	Value				
pattern	[1-9]{1}[0-9]*				

element **Eccedenze_Oltre_Anno_Type/CedolareSecca**

diagram					
namespace	urn:www.agenziaentrate.gov.it:specificheTecniche:sco:p73				
type	DatoNP_Type				
facets	<table border="1"> <tr> <td>Kind</td> <td>Value</td> </tr> <tr> <td>pattern</td> <td>[1-9]{1}[0-9]*</td> </tr> </table>	Kind	Value	pattern	[1-9]{1}[0-9]*
Kind	Value				
pattern	[1-9]{1}[0-9]*				

element **Eccedenze_Oltre_Anno_Type/CodiceRegione**

diagram																																															
namespace	urn:www.agenziaentrate.gov.it:specificheTecniche:sco:p73																																														
type	Codice_Regione_Type																																														
facets	<table border="1"> <tr> <td>Kind</td> <td>Value</td> </tr> <tr> <td>pattern</td> <td>([0-9A-Z\-\]&quot;){1}([0-9A-Z&amp;] \- \., / \° \^ \(\) À È É Ì Ò Ù Ü &quot;; \\ / +)*</td> </tr> <tr> <td>enumeration</td> <td>1</td> </tr> <tr> <td>enumeration</td> <td>2</td> </tr> <tr> <td>enumeration</td> <td>3</td> </tr> <tr> <td>enumeration</td> <td>4</td> </tr> <tr> <td>enumeration</td> <td>5</td> </tr> <tr> <td>enumeration</td> <td>6</td> </tr> <tr> <td>enumeration</td> <td>7</td> </tr> <tr> <td>enumeration</td> <td>8</td> </tr> <tr> <td>enumeration</td> <td>9</td> </tr> <tr> <td>enumeration</td> <td>10</td> </tr> <tr> <td>enumeration</td> <td>11</td> </tr> <tr> <td>enumeration</td> <td>12</td> </tr> <tr> <td>enumeration</td> <td>13</td> </tr> <tr> <td>enumeration</td> <td>14</td> </tr> <tr> <td>enumeration</td> <td>15</td> </tr> <tr> <td>enumeration</td> <td>16</td> </tr> <tr> <td>enumeration</td> <td>17</td> </tr> <tr> <td>enumeration</td> <td>18</td> </tr> <tr> <td>enumeration</td> <td>19</td> </tr> <tr> <td>enumeration</td> <td>20</td> </tr> <tr> <td>enumeration</td> <td>21</td> </tr> </table>	Kind	Value	pattern	([0-9A-Z\-\]"){1}([0-9A-Z&] \- \., / \° \^ \(\) À È É Ì Ò Ù Ü "; \\ / +)*	enumeration	1	enumeration	2	enumeration	3	enumeration	4	enumeration	5	enumeration	6	enumeration	7	enumeration	8	enumeration	9	enumeration	10	enumeration	11	enumeration	12	enumeration	13	enumeration	14	enumeration	15	enumeration	16	enumeration	17	enumeration	18	enumeration	19	enumeration	20	enumeration	21
Kind	Value																																														
pattern	([0-9A-Z\-\]"){1}([0-9A-Z&] \- \., / \° \^ \(\) À È É Ì Ò Ù Ü "; \\ / +)*																																														
enumeration	1																																														
enumeration	2																																														
enumeration	3																																														
enumeration	4																																														
enumeration	5																																														
enumeration	6																																														
enumeration	7																																														
enumeration	8																																														
enumeration	9																																														
enumeration	10																																														
enumeration	11																																														
enumeration	12																																														
enumeration	13																																														
enumeration	14																																														
enumeration	15																																														
enumeration	16																																														
enumeration	17																																														
enumeration	18																																														
enumeration	19																																														
enumeration	20																																														
enumeration	21																																														

element **Eccedenze_Oltre_Anno_Type/AddRegionalelrpef**

diagram					
namespace	urn:www.agenziaentrate.gov.it:specificheTecniche:sco:p73				
type	DatoNP_Type				
facets	<table border="1"> <tr> <td>Kind</td> <td>Value</td> </tr> <tr> <td>pattern</td> <td>[1-9]{1}[0-9]*</td> </tr> </table>	Kind	Value	pattern	[1-9]{1}[0-9]*
Kind	Value				
pattern	[1-9]{1}[0-9]*				

element **Eccedenze_Oltre_Anno_Type/CodiceCatastaleComune**

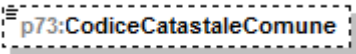
diagram	
namespace	urn:www.agenziaentrate.gov.it:specificheTecniche:sco:p73
type	restriction of DatoAN_Type
facets	Kind Value pattern ([0-9A-Z-] \"){1}([0-9A-Z&:] ' \- \., / ^ \^ \(\) À É È Ì Ò Ù Ü " \ \\ \+)*

element **Eccedenze_Oltre_Anno_Type/AddComunalelrpef**

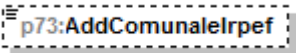
diagram	
namespace	urn:www.agenziaentrate.gov.it:specificheTecniche:sco:p73
type	DatoNP_Type
facets	Kind Value pattern [1-9]{1}[0-9]*

element **Eccedenze_Oltre_Anno_Type/ImpostaSostitutiva**

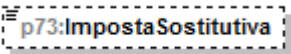
diagram	
namespace	urn:www.agenziaentrate.gov.it:specificheTecniche:sco:p73
type	DatoNP_Type
facets	Kind Value pattern [1-9]{1}[0-9]*

complexType **Eccedenze_Type**

<p>diagram</p>	
<p>namespace</p>	<p>urn:www.agenziaentrate.gov.it:specificheTecniche:sco:p73</p>
<p>children</p>	<p>p73:lrpef p73:lrpefCompF24 p73:SostitutivaQuadroRT p73:SostitutivaQuadroRTcompF24 p73:CedolareSecca p73:CedolareSeccaCompF24 p73:CodiceRegione p73:AddRegionalelrpef p73:AddRegionalelrpefCompF24 p73:CodiceCatastaleComune p73:AddComunalelrpef p73:AddComunalelrpefF24</p>

element **Eccedenze_Type/lrpef**

<p>diagram</p>					
<p>namespace</p>	<p>urn:www.agenziaentrate.gov.it:specificheTecniche:sco:p73</p>				
<p>type</p>	<p>DatoNP_Type</p>				
<p>facets</p>	<table border="1"> <tr> <td>Kind</td> <td>Value</td> </tr> <tr> <td>pattern</td> <td>[1-9]{1}[0-9]*</td> </tr> </table>	Kind	Value	pattern	[1-9]{1}[0-9]*
Kind	Value				
pattern	[1-9]{1}[0-9]*				

element **Eccedenze_Type/lrpefCompF24**

<p>diagram</p>					
<p>namespace</p>	<p>urn:www.agenziaentrate.gov.it:specificheTecniche:sco:p73</p>				
<p>type</p>	<p>DatoNP_Type</p>				
<p>facets</p>	<table border="1"> <tr> <td>Kind</td> <td>Value</td> </tr> <tr> <td>pattern</td> <td>[1-9]{1}[0-9]*</td> </tr> </table>	Kind	Value	pattern	[1-9]{1}[0-9]*
Kind	Value				
pattern	[1-9]{1}[0-9]*				

element Eccedenze_Type/SostitutivaQuadroRT

diagram					
namespace	urn:www.agenziaentrate.gov.it:specificheTecniche:sco:p73				
type	DatoNP_Type				
facets	<table border="1"> <tr> <td>Kind</td> <td>Value</td> </tr> <tr> <td>pattern</td> <td>[1-9]{1}[0-9]*</td> </tr> </table>	Kind	Value	pattern	[1-9]{1}[0-9]*
Kind	Value				
pattern	[1-9]{1}[0-9]*				

element Eccedenze_Type/SostitutivaQuadroRTcompF24

diagram					
namespace	urn:www.agenziaentrate.gov.it:specificheTecniche:sco:p73				
type	DatoNP_Type				
facets	<table border="1"> <tr> <td>Kind</td> <td>Value</td> </tr> <tr> <td>pattern</td> <td>[1-9]{1}[0-9]*</td> </tr> </table>	Kind	Value	pattern	[1-9]{1}[0-9]*
Kind	Value				
pattern	[1-9]{1}[0-9]*				

element Eccedenze_Type/CedolareSecca

diagram					
namespace	urn:www.agenziaentrate.gov.it:specificheTecniche:sco:p73				
type	DatoNP_Type				
facets	<table border="1"> <tr> <td>Kind</td> <td>Value</td> </tr> <tr> <td>pattern</td> <td>[1-9]{1}[0-9]*</td> </tr> </table>	Kind	Value	pattern	[1-9]{1}[0-9]*
Kind	Value				
pattern	[1-9]{1}[0-9]*				

element Eccedenze_Type/CedolareSeccaCompF24

diagram					
namespace	urn:www.agenziaentrate.gov.it:specificheTecniche:sco:p73				
type	DatoNP_Type				
facets	<table border="1"> <tr> <td>Kind</td> <td>Value</td> </tr> <tr> <td>pattern</td> <td>[1-9]{1}[0-9]*</td> </tr> </table>	Kind	Value	pattern	[1-9]{1}[0-9]*
Kind	Value				
pattern	[1-9]{1}[0-9]*				

element Eccedenze_Type/CodiceRegione

diagram									
namespace	urn:www.agenziaentrate.gov.it:specificheTecniche:sco:p73								
type	Codice_Regione_Type								
facets	<table border="1"> <tr> <td>Kind</td> <td>Value</td> </tr> <tr> <td>pattern</td> <td>(([0-9A-Z\-_]\&quot;){1}([0-9A-Z&amp;] '\ -\ \. , / \° \^ \(\) À È É Ì Ò Ù Ü &quot; \ \\ \ +)</td> </tr> <tr> <td>enumeration</td> <td>1</td> </tr> <tr> <td>enumeration</td> <td>2</td> </tr> </table>	Kind	Value	pattern	(([0-9A-Z\-_]\"){1}([0-9A-Z&] '\ -\ \. , / \° \^ \(\) À È É Ì Ò Ù Ü " \ \\ \ +)	enumeration	1	enumeration	2
Kind	Value								
pattern	(([0-9A-Z\-_]\"){1}([0-9A-Z&] '\ -\ \. , / \° \^ \(\) À È É Ì Ò Ù Ü " \ \\ \ +)								
enumeration	1								
enumeration	2								

enumeration	3
enumeration	4
enumeration	5
enumeration	6
enumeration	7
enumeration	8
enumeration	9
enumeration	10
enumeration	11
enumeration	12
enumeration	13
enumeration	14
enumeration	15
enumeration	16
enumeration	17
enumeration	18
enumeration	19
enumeration	20
enumeration	21

element Eccedenze_Type/AddRegionalelrpef

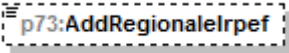
diagram					
namespace	urn:www.agenziaentrate.gov.it:specificheTecniche:sco:p73				
type	DatoNP_Type				
facets	<table border="1"> <thead> <tr> <th>Kind</th> <th>Value</th> </tr> </thead> <tbody> <tr> <td>pattern</td> <td>[1-9]{1}[0-9]*</td> </tr> </tbody> </table>	Kind	Value	pattern	[1-9]{1}[0-9]*
Kind	Value				
pattern	[1-9]{1}[0-9]*				

element Eccedenze_Type/AddRegionalelrpefCompF24

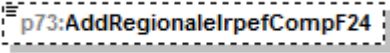
diagram					
namespace	urn:www.agenziaentrate.gov.it:specificheTecniche:sco:p73				
type	DatoNP_Type				
facets	<table border="1"> <thead> <tr> <th>Kind</th> <th>Value</th> </tr> </thead> <tbody> <tr> <td>pattern</td> <td>[1-9]{1}[0-9]*</td> </tr> </tbody> </table>	Kind	Value	pattern	[1-9]{1}[0-9]*
Kind	Value				
pattern	[1-9]{1}[0-9]*				

element Eccedenze_Type/CodiceCatastaleComune

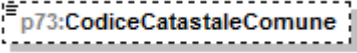
diagram					
namespace	urn:www.agenziaentrate.gov.it:specificheTecniche:sco:p73				
type	restriction of DatoAN_Type				
facets	<table border="1"> <thead> <tr> <th>Kind</th> <th>Value</th> </tr> </thead> <tbody> <tr> <td>pattern</td> <td>([0-9A-Z\-\ &quot;]{1}([0-9A-Z&amp;] '\ _ / ° ^\(\\)\) À É È Ì Ò Ù Ú Û &quot; \\ \\ \\+)*</td> </tr> </tbody> </table>	Kind	Value	pattern	([0-9A-Z\-\ "]{1}([0-9A-Z&] '\ _ / ° ^\(\\)\) À É È Ì Ò Ù Ú Û " \\ \\ \\+)*
Kind	Value				
pattern	([0-9A-Z\-\ "]{1}([0-9A-Z&] '\ _ / ° ^\(\\)\) À É È Ì Ò Ù Ú Û " \\ \\ \\+)*				

element Eccedenze_Type/AddComunalelrpef

diagram	
---------	---

namespace	urn:www.agenziaentrate.gov.it:specificheTecniche:sco:p73
type	DatoNP_Type
facets	Kind Value pattern [1-9]{1}[0-9]*

element **Eccedenze_Type/AddComunalelrpefF24**

diagram	
namespace	urn:www.agenziaentrate.gov.it:specificheTecniche:sco:p73
type	DatoNP_Type
facets	Kind Value pattern [1-9]{1}[0-9]*

complexType **Elemento_Integrativo_Type**

diagram	
namespace	urn:www.agenziaentrate.gov.it:specificheTecniche:sco:p73
children	p73:lrpef p73:AddizionaleRegionalelrpef p73:AddComunalelrpef p73:CedolareSecca

element **Elemento_Integrativo_Type/lrpef**

diagram	
namespace	urn:www.agenziaentrate.gov.it:specificheTecniche:sco:p73
type	DatoNP_Type
facets	Kind Value pattern [1-9]{1}[0-9]*

element **Elemento_Integrativo_Type/AddizionaleRegionalelrpef**

diagram	
namespace	urn:www.agenziaentrate.gov.it:specificheTecniche:sco:p73
type	DatoNP_Type
facets	Kind Value pattern [1-9]{1}[0-9]*

element **Elemento_Integrativo_Type/AddComunalelrpef**

diagram	
namespace	urn:www.agenziaentrate.gov.it:specificheTecniche:sco:p73
type	DatoNP_Type
facets	Kind Value pattern [1-9]{1}[0-9]*

element **Elemento_Integrativo_Type/CedolareSecca**

diagram	
namespace	urn:www.agenziaentrate.gov.it:specificheTecniche:sco:p73
type	DatoNP_Type
facets	Kind Value pattern [1-9]{1}[0-9]*

complexType **Esenzione_Add_Comunale_Type**

diagram	
namespace	urn:www.agenziaentrate.gov.it:specificheTecniche:sco:p73
children	p73:SogliaEsenzioneSaldo p73:SogliaEsenzioneAcconto

element **Esenzione_Add_Comunale_Type/SogliaEsenzioneSaldo**

diagram	
namespace	urn:www.agenziaentrate.gov.it:specificheTecniche:sco:p73
type	p73:Soglie_Esenzione_Type
children	p73:SogliaEsenzione p73:EsenzioneTotale

element Esenzione_Add_Comunale_Type/SogliaEsenzioneAcconto

diagram	
namespace	urn:www.agenziaentrate.gov.it:specificheTecniche:sco:p73
type	p73:Soglie_Esenzione_Type
children	p73:SogliaEsenzione p73:EsenzioneTotale

complexType Esenzione_Bonus_Type

diagram	
namespace	urn:www.agenziaentrate.gov.it:specificheTecniche:sco:p73
children	p73:TipologiaEsenzione p73:ParteRedditoEsente

element Esenzione_Bonus_Type/TipologiaEsenzione

diagram									
namespace	urn:www.agenziaentrate.gov.it:specificheTecniche:sco:p73								
type	restriction of DatoN1_Type								
facets	<table border="1"> <thead> <tr> <th>Kind</th> <th>Value</th> </tr> </thead> <tbody> <tr> <td>pattern</td> <td>[1-9]</td> </tr> <tr> <td>enumeration</td> <td>1</td> </tr> <tr> <td>enumeration</td> <td>2</td> </tr> </tbody> </table>	Kind	Value	pattern	[1-9]	enumeration	1	enumeration	2
Kind	Value								
pattern	[1-9]								
enumeration	1								
enumeration	2								

element Esenzione_Bonus_Type/ParteRedditoEsente

diagram					
namespace	urn:www.agenziaentrate.gov.it:specificheTecniche:sco:p73				
type	DatoNP_Type				
facets	<table border="1"> <thead> <tr> <th>Kind</th> <th>Value</th> </tr> </thead> <tbody> <tr> <td>pattern</td> <td>[1-9]{1}[0-9]*</td> </tr> </tbody> </table>	Kind	Value	pattern	[1-9]{1}[0-9]*
Kind	Value				
pattern	[1-9]{1}[0-9]*				

complexType **Esito_Liquidazione_Type**

diagram	<p>The diagram shows a complexType named 'Esito_Liquidazione_Type' connected to a choice symbol (a circle with a vertical line and a horizontal line). This choice symbol branches into two child elements: 'p73:Credito' and 'p73:Debito', both with a '+' sign in the top right corner, indicating they are optional.</p>
namespace	urn:www.agenziaentrate.gov.it:specificheTecniche:sco:p73
children	p73:Credito p73:Debito

element **Esito_Liquidazione_Type/Credito**

diagram	<p>The diagram shows an element named 'p73:Credito' connected to a choice symbol. This choice symbol branches into four child elements: 'p73:NonRimborsabile', 'p73:Credito', 'p73:CreditoF24', and 'p73:CreditoRimborso'. These four elements are grouped within a dashed yellow box labeled 'p73:Credito_Type'. Each child element has a '+' sign in the top right corner, indicating they are optional.</p>
namespace	urn:www.agenziaentrate.gov.it:specificheTecniche:sco:p73
type	p73:Credito_Type
children	p73:NonRimborsabile p73:Credito p73:CreditoF24 p73:CreditoRimborso

element **Esito_Liquidazione_Type/Debito**

diagram	<p>The diagram shows an element named 'p73:Debito' connected to a choice symbol. This choice symbol branches into two child elements: 'p73:NonVersare' and 'p73:ImportoDaTrattenere'. These two elements are grouped within a dashed yellow box labeled 'p73:Debito_Type'. Each child element has a '+' sign in the top right corner, indicating they are optional.</p>
namespace	urn:www.agenziaentrate.gov.it:specificheTecniche:sco:p73
type	p73:Debito_Type
children	p73:NonVersare p73:ImportoDaTrattenere

complexType **Fabbricato_Agev_Type**

diagram	
namespace	urn:www.agenziaentrate.gov.it:specificheTecniche:sco:p73
children	p73:NumeroRigoRiferimento p73:NumModuloRiferimento p73:DatiContratto p73:CasellaInf30Giorni p73:AnnoDichiarazioneIcilmu p73:StatoEmergenza

element **Fabbricato_Agev_Type/NumeroRigoRiferimento**

diagram																									
namespace	urn:www.agenziaentrate.gov.it:specificheTecniche:sco:p73																								
type	p73:Fabbricato_Agev_Numero_Rigo_Type																								
facets	<table border="1"> <thead> <tr> <th>Kind</th> <th>Value</th> </tr> </thead> <tbody> <tr> <td>pattern</td> <td>[1-9]{1}[0-9]*</td> </tr> <tr> <td>enumeration</td> <td>1</td> </tr> <tr> <td>enumeration</td> <td>2</td> </tr> <tr> <td>enumeration</td> <td>3</td> </tr> <tr> <td>enumeration</td> <td>4</td> </tr> <tr> <td>enumeration</td> <td>5</td> </tr> <tr> <td>enumeration</td> <td>6</td> </tr> <tr> <td>enumeration</td> <td>7</td> </tr> <tr> <td>enumeration</td> <td>8</td> </tr> <tr> <td>enumeration</td> <td>9</td> </tr> <tr> <td>enumeration</td> <td>10</td> </tr> </tbody> </table>	Kind	Value	pattern	[1-9]{1}[0-9]*	enumeration	1	enumeration	2	enumeration	3	enumeration	4	enumeration	5	enumeration	6	enumeration	7	enumeration	8	enumeration	9	enumeration	10
Kind	Value																								
pattern	[1-9]{1}[0-9]*																								
enumeration	1																								
enumeration	2																								
enumeration	3																								
enumeration	4																								
enumeration	5																								
enumeration	6																								
enumeration	7																								
enumeration	8																								
enumeration	9																								
enumeration	10																								

element **Fabbricato_Agev_Type/NumModuloRiferimento**

diagram					
namespace	urn:www.agenziaentrate.gov.it:specificheTecniche:sco:p73				
type	DatoNP_Type				
facets	<table border="1"> <thead> <tr> <th>Kind</th> <th>Value</th> </tr> </thead> <tbody> <tr> <td>pattern</td> <td>[1-9]{1}[0-9]*</td> </tr> </tbody> </table>	Kind	Value	pattern	[1-9]{1}[0-9]*
Kind	Value				
pattern	[1-9]{1}[0-9]*				

element **Fabbricato_Agev_Type/DatiContratto**

diagram	
namespace	urn:www.agenziaentrate.gov.it:specificheTecniche:sco:p73
type	p73:Dati_Contratto_Type
children	p73:DataRegContratto p73:SerieContratto p73:NumeroContratto p73:Sottonumero p73:CodiceUfficio p73:IdentificativoContratto

element **Fabbricato_Agev_Type/CasellaInf30Giorni**

diagram					
namespace	urn:www.agenziaentrate.gov.it:specificheTecniche:sco:p73				
type	DatoCB_Type				
facets	<table border="1"> <thead> <tr> <th>Kind</th> <th>Value</th> </tr> </thead> <tbody> <tr> <td>pattern</td> <td>[01]</td> </tr> </tbody> </table>	Kind	Value	pattern	[01]
Kind	Value				
pattern	[01]				

element **Fabbricato_Agev_Type/AnnoDichiarazioneIcilmu**

diagram					
namespace	urn:www.agenziaentrate.gov.it:specificheTecniche:sco:p73				
type	DatoDA_Type				
facets	<table border="1"> <thead> <tr> <th>Kind</th> <th>Value</th> </tr> </thead> <tbody> <tr> <td>pattern</td> <td>(18 19 20)[0-9]{2}</td> </tr> </tbody> </table>	Kind	Value	pattern	(18 19 20)[0-9]{2}
Kind	Value				
pattern	(18 19 20)[0-9]{2}				

element **Fabbricato_Agev_Type/StatoEmergenza**

diagram	
namespace	urn:www.agenziaentrate.gov.it:specificheTecniche:sco:p73
type	DatoCB_Type

facets	Kind pattern	Value [01]
--------	-----------------	---------------

complexType Fabbricato_Ord_Type

diagram	
namespace	urn:www.agenziaentrate.gov.it:specificheTecniche:sco:p73
children	p73:Rendita p73:Utilizzo p73:GiorniPossesso p73:PercPossesso p73:CodiceCanone p73:CanoneLocazione p73:CasiParticolari p73:CasellaContinuazione p73:CodiceComune p73:OpzioneCedolare p73:CasellaCasiPartimu

element Fabbricato_Ord_Type/Rendita

diagram		
namespace	urn:www.agenziaentrate.gov.it:specificheTecniche:sco:p73	
type	DatoNP_Type	
facets	Kind pattern	Value [1-9]{1}[0-9]*

element Fabbricato_Ord_Type/Utilizzo

diagram		
namespace	urn:www.agenziaentrate.gov.it:specificheTecniche:sco:p73	
type	restriction of p73:Utilizzo_Fabbricato_Type	
facets	Kind pattern	Value [1-9]{1}[0-9]*

enumeration	1
enumeration	2
enumeration	3
enumeration	4
enumeration	5
enumeration	8
enumeration	9
enumeration	10
enumeration	11
enumeration	12
enumeration	14
enumeration	15
enumeration	16
enumeration	17

element Fabbricato_Ord_Type/GiorniPossesso

diagram					
namespace	urn:www.agenziaentrate.gov.it:specificheTecniche:sco:p73				
type	restriction of DatoNP_Type				
facets	<table border="1"> <tr><td>Kind</td><td>Value</td></tr> <tr><td>pattern</td><td>[1-9]{1}[0-9]*</td></tr> </table>	Kind	Value	pattern	[1-9]{1}[0-9]*
Kind	Value				
pattern	[1-9]{1}[0-9]*				

element Fabbricato_Ord_Type/PercPossesso

diagram					
namespace	urn:www.agenziaentrate.gov.it:specificheTecniche:sco:p73				
type	DatoPC_Type				
facets	<table border="1"> <tr><td>Kind</td><td>Value</td></tr> <tr><td>pattern</td><td>[0-9]?[0-9](,\d{1,3})? 100,(0{1,3})?</td></tr> </table>	Kind	Value	pattern	[0-9]?[0-9](,\d{1,3})? 100,(0{1,3})?
Kind	Value				
pattern	[0-9]?[0-9](,\d{1,3})? 100,(0{1,3})?				

element Fabbricato_Ord_Type/CodiceCanone

diagram													
namespace	urn:www.agenziaentrate.gov.it:specificheTecniche:sco:p73												
type	p73:Codice Canone_Type												
facets	<table border="1"> <tr><td>Kind</td><td>Value</td></tr> <tr><td>pattern</td><td>[1-9]</td></tr> <tr><td>enumeration</td><td>1</td></tr> <tr><td>enumeration</td><td>2</td></tr> <tr><td>enumeration</td><td>3</td></tr> <tr><td>enumeration</td><td>4</td></tr> </table>	Kind	Value	pattern	[1-9]	enumeration	1	enumeration	2	enumeration	3	enumeration	4
Kind	Value												
pattern	[1-9]												
enumeration	1												
enumeration	2												
enumeration	3												
enumeration	4												

element Fabbricato_Ord_Type/CanoneLocazione

diagram	
namespace	urn:www.agenziaentrate.gov.it:specificheTecniche:sco:p73

type	DatoNP_Type
facets	Kind Value pattern [1-9]{1}[0-9]*

element Fabbricato_Ord_Type/CasiParticolari

diagram	
namespace	urn:www.agenziaentrate.gov.it:specificheTecniche:sco:p73
type	p73:Casi Particolari Fabbricato_Type
facets	Kind Value pattern [1-9] enumeration 1 enumeration 3 enumeration 4 enumeration 5

element Fabbricato_Ord_Type/CasellaContinuazione

diagram	
namespace	urn:www.agenziaentrate.gov.it:specificheTecniche:sco:p73
type	DatoCB_Type
facets	Kind Value pattern [01]

element Fabbricato_Ord_Type/CodiceComune

diagram	
namespace	urn:www.agenziaentrate.gov.it:specificheTecniche:sco:p73
type	restriction of DatoAN_Type
facets	Kind Value pattern ([0-9A-Z-] "){1}([0-9A-Z&] ' \" \\. / ° \"\\(\\) À É È Ì Ò Ù Û " \\\" \\+)*

element Fabbricato_Ord_Type/OpzioneCedolare

diagram	
namespace	urn:www.agenziaentrate.gov.it:specificheTecniche:sco:p73
type	DatoCB_Type
facets	Kind Value pattern [01]

element **Fabbricato_Ord_Type/CasellaCasiPartImu**

diagram											
namespace	urn:www.agenziaentrate.gov.it:specificheTecniche:sco:p73										
type	restriction of DatoN1_Type										
facets	<table border="1"> <thead> <tr> <th>Kind</th> <th>Value</th> </tr> </thead> <tbody> <tr> <td>pattern</td> <td>[1-9]</td> </tr> <tr> <td>enumeration</td> <td>1</td> </tr> <tr> <td>enumeration</td> <td>2</td> </tr> <tr> <td>enumeration</td> <td>3</td> </tr> </tbody> </table>	Kind	Value	pattern	[1-9]	enumeration	1	enumeration	2	enumeration	3
Kind	Value										
pattern	[1-9]										
enumeration	1										
enumeration	2										
enumeration	3										

complexType **Familiari_Type**

diagram	
namespace	urn:www.agenziaentrate.gov.it:specificheTecniche:sco:p73
children	p73:PrimoModulo p73:Modulo

element **Familiari_Type/PrimoModulo**

diagram	
namespace	urn:www.agenziaentrate.gov.it:specificheTecniche:sco:p73
type	p73:Primo Modulo Familiari_Type
children	p73:Coniuge p73:PrimoFiglio p73:Familiari p73:PercUlteriore p73:FigliAffidoPread

element Familiari_Type/Modulo

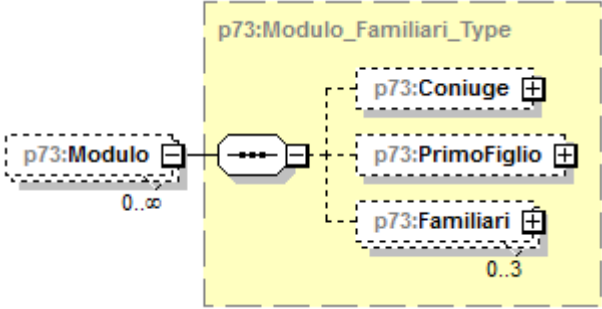
diagram	
namespace	urn:www.agenziaentrate.gov.it:specificheTecniche:sco:p73
type	p73:Modulo_Familiari_Type
children	p73:Coniuge p73:PrimoFiglio p73:Familiari

complexType Fondo_Pensione_Dipendenti_Pubblici_Type

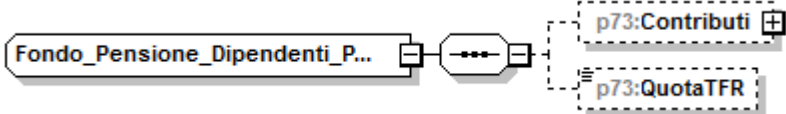
diagram	
namespace	urn:www.agenziaentrate.gov.it:specificheTecniche:sco:p73
children	p73:Contributi p73:QuotaTFR

element Fondo_Pensione_Dipendenti_Pubblici_Type/Contributi

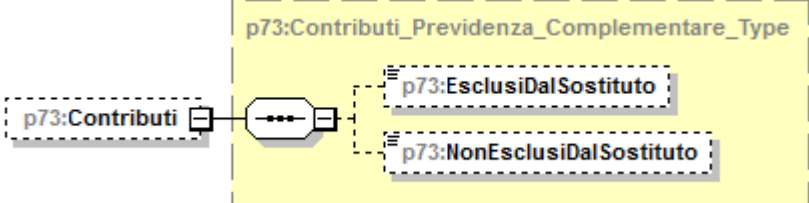
diagram	
namespace	urn:www.agenziaentrate.gov.it:specificheTecniche:sco:p73
type	p73:Contributi_Previdenza_Complementare_Type
children	p73:EsclusiDalSostituto p73:NonEsclusiDalSostituto

element Fondo_Pensione_Dipendenti_Pubblici_Type/QuotaTFR

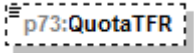
diagram					
namespace	urn:www.agenziaentrate.gov.it:specificheTecniche:sco:p73				
type	DatoNP_Type				
facets	<table border="0"> <tr> <td>Kind</td> <td>Value</td> </tr> <tr> <td>pattern</td> <td>[1-9]{1}[0-9]*</td> </tr> </table>	Kind	Value	pattern	[1-9]{1}[0-9]*
Kind	Value				
pattern	[1-9]{1}[0-9]*				

complexType Frontespizio_730_Type

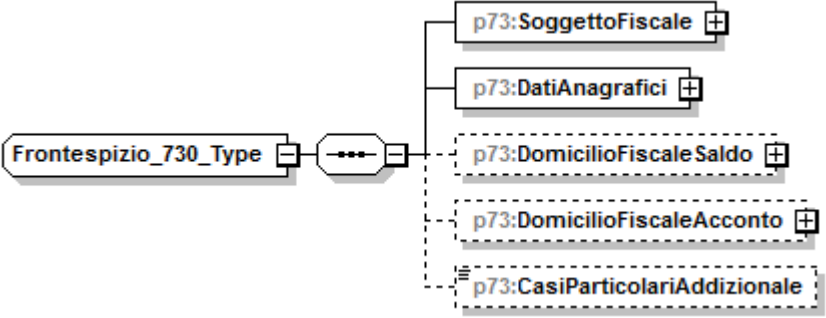
<p>diagram</p>	 <p>The diagram shows a complex type 'Frontespizio_730_Type' connected to a container. This container holds five elements: 'p73:SoggettoFiscale' (solid box), 'p73:DatiAnagrafici' (solid box), 'p73:DomicilioFiscale Saldo' (dashed box), 'p73:DomicilioFiscaleAcconto' (dashed box), and 'p73:CasiParticolariAddizionale' (dashed box).</p>
<p>namespace</p>	<p>urn:www.agenziaentrate.gov.it:specificheTecniche:sco:p73</p>
<p>children</p>	<p>p73:SoggettoFiscale p73:DatiAnagrafici p73:DomicilioFiscaleSaldo p73:DomicilioFiscaleAcconto p73:CasiParticolariAddizionale</p>

element Frontespizio_730_Type/SoggettoFiscale

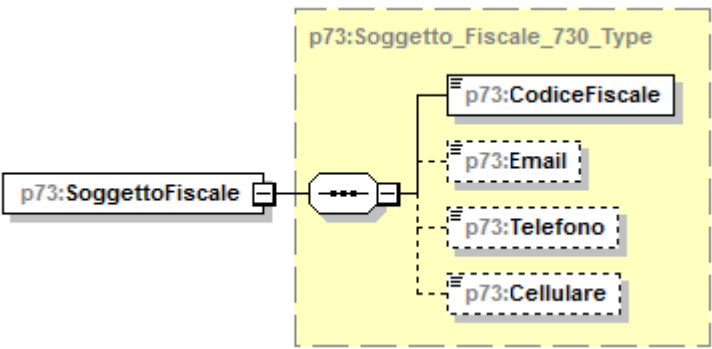
<p>diagram</p>	 <p>The diagram shows the 'p73:SoggettoFiscale' element connected to a container. This container is highlighted in yellow and labeled 'p73:Soggetto_Fiscale_730_Type'. It contains four elements: 'p73:CodiceFiscale' (solid box), 'p73:Email' (dashed box), 'p73:Telefono' (dashed box), and 'p73:Cellulare' (dashed box).</p>
<p>namespace</p>	<p>urn:www.agenziaentrate.gov.it:specificheTecniche:sco:p73</p>
<p>type</p>	<p>p73:Soggetto_Fiscale_730_Type</p>
<p>children</p>	<p>p73:CodiceFiscale p73:Email p73:Telefono p73:Cellulare</p>

element **Frontespizio_730_Type/DatiAnagrafici**

<p>diagram</p>	
<p>namespace</p>	<p>urn:www.agenziaentrate.gov.it:specificheTecniche:sco:p73</p>
<p>type</p>	<p>Dati_Anagrafici_Type</p>
<p>children</p>	<p>Cognome Nome Sesso DataNascita ComuneNascita ProvinciaNascita</p>

element **Frontespizio_730_Type/DomicilioFiscaleSaldo**

<p>diagram</p>	
<p>namespace</p>	<p>urn:www.agenziaentrate.gov.it:specificheTecniche:sco:p73</p>
<p>type</p>	<p>p73:Domicilio_Fiscale_Type</p>
<p>children</p>	<p>p73:Comune p73:Provincia p73:CodiceComune</p>

element Frontespizio_730_Type/DomicilioFiscaleAcconto

diagram	
namespace	urn:www.agenziaentrate.gov.it:specificheTecniche:sco:p73
type	p73:Domicilio_Fiscale_Acconto_Type
children	p73:Comune p73:Provincia p73:CodiceComune p73:FusioneComuni

element Frontespizio_730_Type/CasiParticolariAddizionale

diagram					
namespace	urn:www.agenziaentrate.gov.it:specificheTecniche:sco:p73				
type	DatoCB_Type				
facets	<table border="1"> <thead> <tr> <th>Kind</th> <th>Value</th> </tr> </thead> <tbody> <tr> <td>pattern</td> <td>[01]</td> </tr> </tbody> </table>	Kind	Value	pattern	[01]
Kind	Value				
pattern	[01]				

complexType Giorni_Percentuale_Type

diagram	
namespace	urn:www.agenziaentrate.gov.it:specificheTecniche:sco:p73
children	p73:Giorni p73:Percentuale

element Giorni_Percentuale_Type/Giorni

diagram					
namespace	urn:www.agenziaentrate.gov.it:specificheTecniche:sco:p73				
type	DatoNP_Type				
facets	<table border="1"> <thead> <tr> <th>Kind</th> <th>Value</th> </tr> </thead> <tbody> <tr> <td>pattern</td> <td>[1-9]{1}[0-9]*</td> </tr> </tbody> </table>	Kind	Value	pattern	[1-9]{1}[0-9]*
Kind	Value				
pattern	[1-9]{1}[0-9]*				

element Giorni_Percentuale_Type/Percentuale

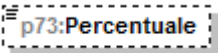
diagram					
namespace	urn:www.agenziaentrate.gov.it:specificheTecniche:sco:p73				
type	DatoPC_Type				
facets	<table border="0"> <tr> <td>Kind</td> <td>Value</td> </tr> <tr> <td>pattern</td> <td>[0-9]?[0-9](, d{1,3})? 100,0{1,3}?</td> </tr> </table>	Kind	Value	pattern	[0-9]?[0-9](, d{1,3})? 100,0{1,3}?
Kind	Value				
pattern	[0-9]?[0-9](, d{1,3})? 100,0{1,3}?				

complexType Imposta_Lorda_Type

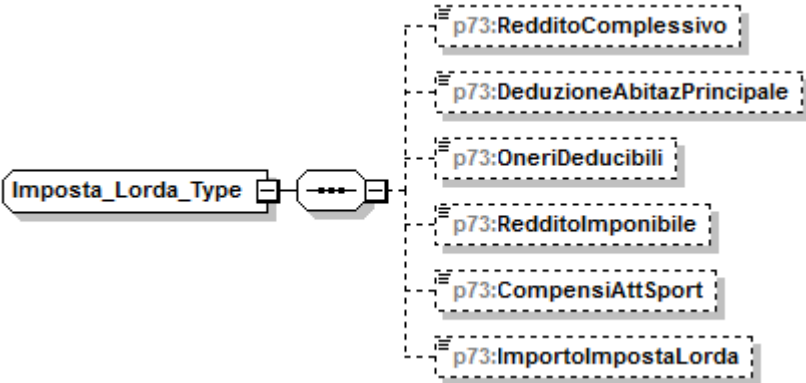
diagram	
namespace	urn:www.agenziaentrate.gov.it:specificheTecniche:sco:p73
children	p73:RedditoComplessivo p73:DeduzioneAbitazPrincipale p73:OneriDeducibili p73:RedditoImponibile p73:CompensiAttSport p73:ImportoImpostaLorda

element Imposta_Lorda_Type/RedditoComplessivo

diagram					
namespace	urn:www.agenziaentrate.gov.it:specificheTecniche:sco:p73				
type	DatoNP_Type				
facets	<table border="0"> <tr> <td>Kind</td> <td>Value</td> </tr> <tr> <td>pattern</td> <td>[1-9]{1}[0-9]*</td> </tr> </table>	Kind	Value	pattern	[1-9]{1}[0-9]*
Kind	Value				
pattern	[1-9]{1}[0-9]*				

element Imposta_Lorda_Type/DeduzioneAbitazPrincipale

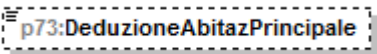
diagram					
namespace	urn:www.agenziaentrate.gov.it:specificheTecniche:sco:p73				
type	DatoNP_Type				
facets	<table border="0"> <tr> <td>Kind</td> <td>Value</td> </tr> <tr> <td>pattern</td> <td>[1-9]{1}[0-9]*</td> </tr> </table>	Kind	Value	pattern	[1-9]{1}[0-9]*
Kind	Value				
pattern	[1-9]{1}[0-9]*				

element **Imposta_Lorda_Type/OneriDeducibili**

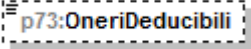
diagram					
namespace	urn:www.agenziaentrate.gov.it:specificheTecniche:sco:p73				
type	DatoNP_Type				
facets	<table border="1"> <tr> <td>Kind</td> <td>Value</td> </tr> <tr> <td>pattern</td> <td>[1-9]{1}[0-9]*</td> </tr> </table>	Kind	Value	pattern	[1-9]{1}[0-9]*
Kind	Value				
pattern	[1-9]{1}[0-9]*				

element **Imposta_Lorda_Type/RedditolImponibile**

diagram					
namespace	urn:www.agenziaentrate.gov.it:specificheTecniche:sco:p73				
type	DatoNP_Type				
facets	<table border="1"> <tr> <td>Kind</td> <td>Value</td> </tr> <tr> <td>pattern</td> <td>[1-9]{1}[0-9]*</td> </tr> </table>	Kind	Value	pattern	[1-9]{1}[0-9]*
Kind	Value				
pattern	[1-9]{1}[0-9]*				

element **Imposta_Lorda_Type/CompensiAttSport**

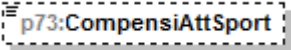
diagram					
namespace	urn:www.agenziaentrate.gov.it:specificheTecniche:sco:p73				
type	DatoNP_Type				
facets	<table border="1"> <tr> <td>Kind</td> <td>Value</td> </tr> <tr> <td>pattern</td> <td>[1-9]{1}[0-9]*</td> </tr> </table>	Kind	Value	pattern	[1-9]{1}[0-9]*
Kind	Value				
pattern	[1-9]{1}[0-9]*				

element **Imposta_Lorda_Type/ImportolImpostaLorda**

diagram					
namespace	urn:www.agenziaentrate.gov.it:specificheTecniche:sco:p73				
type	DatoNP_Type				
facets	<table border="1"> <tr> <td>Kind</td> <td>Value</td> </tr> <tr> <td>pattern</td> <td>[1-9]{1}[0-9]*</td> </tr> </table>	Kind	Value	pattern	[1-9]{1}[0-9]*
Kind	Value				
pattern	[1-9]{1}[0-9]*				

complexType **Imposta_Netta_Type**

<p>diagram</p>	
<p>namespace</p>	<p>urn:www.agenziaentrate.gov.it:specificheTecniche:sco:p73</p>
<p>children</p>	<p>p73:ImportoImpostaNetta p73:CredAltriSisma p73:CredAbitazSisma p73:CredImpEstere p73:CredErogCultura p73:CredErogScuola p73:CredVideosorveglianza p73:CredCanNonPerc p73:CredDetrazIncapienti p73:Ritenute p73:Differenza p73:EccedenzaIrpef p73:AccontiVersati p73:RestituzioneBonus p73:CredRimborsatiSost p73:BonusIrpefSpettante p73:BonusIrpefRiconosciuto p73:RestituzioneBonusIrpef</p>

element **Imposta_Netta_Type/ImportoImpostaNetta**

<p>diagram</p>	
<p>namespace</p>	<p>urn:www.agenziaentrate.gov.it:specificheTecniche:sco:p73</p>
<p>type</p>	<p>DatoNP_Type</p>

facets	Kind pattern	Value [1-9]{1}[0-9]*
--------	-----------------	-------------------------

element **Imposta_Netta_Type/CredAltriSisma**

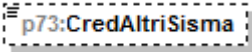
diagram		
namespace	urn:www.agenziaentrate.gov.it:specificheTecniche:sco:p73	
type	DatoNP_Type	
facets	Kind pattern	Value [1-9]{1}[0-9]*

element **Imposta_Netta_Type/CredAbitazSisma**

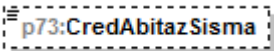
diagram		
namespace	urn:www.agenziaentrate.gov.it:specificheTecniche:sco:p73	
type	DatoNP_Type	
facets	Kind pattern	Value [1-9]{1}[0-9]*

element **Imposta_Netta_Type/CredImpEstere**

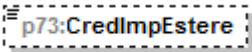
diagram		
namespace	urn:www.agenziaentrate.gov.it:specificheTecniche:sco:p73	
type	DatoNP_Type	
facets	Kind pattern	Value [1-9]{1}[0-9]*

element **Imposta_Netta_Type/CredErogCultura**

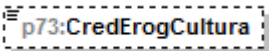
diagram		
namespace	urn:www.agenziaentrate.gov.it:specificheTecniche:sco:p73	
type	DatoNP_Type	
facets	Kind pattern	Value [1-9]{1}[0-9]*

element **Imposta_Netta_Type/CredErogScuola**

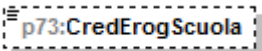
diagram		
namespace	urn:www.agenziaentrate.gov.it:specificheTecniche:sco:p73	
type	DatoNP_Type	

facets	Kind pattern	Value [1-9]{1}[0-9]*
--------	-----------------	-------------------------

element Imposta_Netta_Type/CredVideosorveglianza

diagram		
namespace	urn:www.agenziaentrate.gov.it:specificheTecniche:sco:p73	
type	DatoNP_Type	
facets	Kind pattern	Value [1-9]{1}[0-9]*

element Imposta_Netta_Type/CredCanNonPerc

diagram		
namespace	urn:www.agenziaentrate.gov.it:specificheTecniche:sco:p73	
type	DatoNP_Type	
facets	Kind pattern	Value [1-9]{1}[0-9]*

element Imposta_Netta_Type/CredDetrazIncapienti

diagram		
namespace	urn:www.agenziaentrate.gov.it:specificheTecniche:sco:p73	
type	DatoNP_Type	
facets	Kind pattern	Value [1-9]{1}[0-9]*

element Imposta_Netta_Type/Ritenute

diagram		
namespace	urn:www.agenziaentrate.gov.it:specificheTecniche:sco:p73	
type	DatoNP_Type	
facets	Kind pattern	Value [1-9]{1}[0-9]*

element Imposta_Netta_Type/Differenza

diagram		
namespace	urn:www.agenziaentrate.gov.it:specificheTecniche:sco:p73	
type	DatoNU_Type	

facets	Kind pattern	Value (\[1-9\]\[1-9\]\[0-9\]*)
--------	-----------------	-----------------------------------

element Imposta_Netta_Type/Eccedenzalrpef

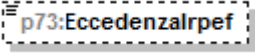
diagram		
namespace	urn:www.agenziaentrate.gov.it:specificheTecniche:sco:p73	
type	DatoNU_Type	
facets	Kind pattern	Value (\[1-9\]\[1-9\]\[0-9\]*)

element Imposta_Netta_Type/AcontiVersati

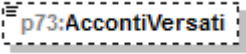
diagram		
namespace	urn:www.agenziaentrate.gov.it:specificheTecniche:sco:p73	
type	DatoNP_Type	
facets	Kind pattern	Value \[1-9\]\{1\}\[0-9\]*

element Imposta_Netta_Type/RestituzioneBonus

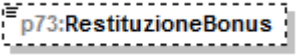
diagram		
namespace	urn:www.agenziaentrate.gov.it:specificheTecniche:sco:p73	
type	DatoNP_Type	
facets	Kind pattern	Value \[1-9\]\{1\}\[0-9\]*

element Imposta_Netta_Type/CredRimborsatiSost

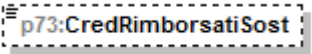
diagram		
namespace	urn:www.agenziaentrate.gov.it:specificheTecniche:sco:p73	
type	DatoNP_Type	
facets	Kind pattern	Value \[1-9\]\{1\}\[0-9\]*

element Imposta_Netta_Type/BonuslrpefSpettante

diagram		
namespace	urn:www.agenziaentrate.gov.it:specificheTecniche:sco:p73	
type	DatoNP_Type	

facets	Kind	Value
	pattern	[1-9]{1}[0-9]*

element Imposta_Netta_Type/BonuslrpefRiconosciuto

diagram	
namespace	urn:www.agenziaentrate.gov.it:specificheTecniche:sco:p73
type	DatoNP_Type
facets	Kind Value pattern [1-9]{1}[0-9]*

element Imposta_Netta_Type/RestituzioneBonuslrpef

diagram	
namespace	urn:www.agenziaentrate.gov.it:specificheTecniche:sco:p73
type	DatoNP_Type
facets	Kind Value pattern [1-9]{1}[0-9]*

complexType Imposte_Rimborsate_Type

diagram	
namespace	urn:www.agenziaentrate.gov.it:specificheTecniche:sco:p73
children	p73:TipoReddito p73:TassazioneSeparata

element Imposte_Rimborsate_Type/TipoReddito

diagram	
namespace	urn:www.agenziaentrate.gov.it:specificheTecniche:sco:p73
type	p73:Tipo_Reddito_Da1a8_Type
facets	Kind Value pattern [1-9]{1}[0-9]* enumeration 1 enumeration 2 enumeration 3 enumeration 4 enumeration 5 enumeration 6 enumeration 7 enumeration 8

element **Imposte_Rimborsate_Type/TassazioneSeparata**

diagram	
namespace	urn:www.agenziaentrate.gov.it:specificheTecniche:sco:p73
type	p73:Tassazione_Separata_Type
children	p73:Opzione p73:Anno p73:RedditoRitenute

complexType **Incremento_Produttivita_Type**

diagram	
namespace	urn:www.agenziaentrate.gov.it:specificheTecniche:sco:p73
children	p73:ImportoTassazOrdinaria p73:ImportoImpostaSostitutiva p73:RitenuteImpostaSostitutiva p73:Art51Ordinaria p73:Art51Sostitutiva p73:TassazOrdinaria p73:TassazSostitutiva

element **Incremento_Produttivita_Type/ImportoTassazOrdinaria**

diagram					
namespace	urn:www.agenziaentrate.gov.it:specificheTecniche:sco:p73				
type	DatoNP_Type				
facets	<table border="1"> <thead> <tr> <th>Kind</th> <th>Value</th> </tr> </thead> <tbody> <tr> <td>pattern</td> <td>[1-9]{1}[0-9]*</td> </tr> </tbody> </table>	Kind	Value	pattern	[1-9]{1}[0-9]*
Kind	Value				
pattern	[1-9]{1}[0-9]*				

element Incremento_Produttivita_Type/ImportoImpostaSostitutiva

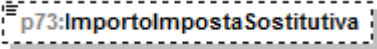
diagram	
namespace	urn:www.agenziaentrate.gov.it:specificheTecniche:sco:p73
type	DatoNP_Type
facets	Kind Value pattern [1-9]{1}[0-9]*

element Incremento_Produttivita_Type/RitenuteImpostaSostitutiva

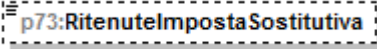
diagram	
namespace	urn:www.agenziaentrate.gov.it:specificheTecniche:sco:p73
type	DatoNP_Type
facets	Kind Value pattern [1-9]{1}[0-9]*

element Incremento_Produttivita_Type/Art51Ordinaria

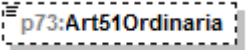
diagram	
namespace	urn:www.agenziaentrate.gov.it:specificheTecniche:sco:p73
type	DatoNP_Type
facets	Kind Value pattern [1-9]{1}[0-9]*

element Incremento_Produttivita_Type/Art51Sostitutiva

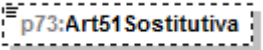
diagram	
namespace	urn:www.agenziaentrate.gov.it:specificheTecniche:sco:p73
type	DatoNP_Type
facets	Kind Value pattern [1-9]{1}[0-9]*

element Incremento_Produttivita_Type/TassazOrdinaria

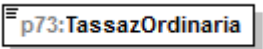
diagram	
namespace	urn:www.agenziaentrate.gov.it:specificheTecniche:sco:p73
type	DatoCB_Type
facets	Kind Value pattern [01]

element Incremento_Produttivita_Type/TassazSostitutiva

diagram	
namespace	urn:www.agenziaentrate.gov.it:specificheTecniche:sco:p73
type	DatoCB_Type
facets	Kind Value pattern [01]

complexType Inquilini_Abitazione_Principale_Type

diagram	
namespace	urn:www.agenziaentrate.gov.it:specificheTecniche:sco:p73
children	p73:Tipologia p73:GiorniPercentuale

element Inquilini_Abitazione_Principale_Type/Tipologia

diagram	
namespace	urn:www.agenziaentrate.gov.it:specificheTecniche:sco:p73
type	p73:Tipo_Inquilino_Type
facets	Kind Value pattern [1-9]{1}[0-9]* enumeration 1 enumeration 2 enumeration 3 enumeration 4

element Inquilini_Abitazione_Principale_Type/GiorniPercentuale

diagram	
namespace	urn:www.agenziaentrate.gov.it:specificheTecniche:sco:p73
type	p73:Giorni_Percentuale_Type
children	p73:Giorni p73:Percentuale

complexType **Intervento_Ricupero_Patrimonio_Edilizio_Type**

diagram	
namespace	urn:www.agenziaentrate.gov.it:specificheTecniche:sco:p73
children	p73:Anno p73:Periodo p73:CodiceFiscale p73:CasellaInterventiParticolari p73:CodiceSituazioniParticolari p73:Rate10 p73:Spesa p73:NOrdineImmobile

element **Intervento_Ricupero_Patrimonio_Edilizio_Type/Anno**

diagram																									
namespace	urn:www.agenziaentrate.gov.it:specificheTecniche:sco:p73																								
type	restriction of p73:Anno_Ricupero_Patrimonio_Edilizio_Type																								
facets	<table border="0"> <tr> <td>Kind</td> <td>Value</td> </tr> <tr> <td>pattern</td> <td>[1-9]{1}[0-9]*</td> </tr> <tr> <td>enumeration</td> <td>2007</td> </tr> <tr> <td>enumeration</td> <td>2008</td> </tr> <tr> <td>enumeration</td> <td>2009</td> </tr> <tr> <td>enumeration</td> <td>2010</td> </tr> <tr> <td>enumeration</td> <td>2011</td> </tr> <tr> <td>enumeration</td> <td>2012</td> </tr> <tr> <td>enumeration</td> <td>2013</td> </tr> <tr> <td>enumeration</td> <td>2014</td> </tr> <tr> <td>enumeration</td> <td>2015</td> </tr> <tr> <td>enumeration</td> <td>2016</td> </tr> </table>	Kind	Value	pattern	[1-9]{1}[0-9]*	enumeration	2007	enumeration	2008	enumeration	2009	enumeration	2010	enumeration	2011	enumeration	2012	enumeration	2013	enumeration	2014	enumeration	2015	enumeration	2016
Kind	Value																								
pattern	[1-9]{1}[0-9]*																								
enumeration	2007																								
enumeration	2008																								
enumeration	2009																								
enumeration	2010																								
enumeration	2011																								
enumeration	2012																								
enumeration	2013																								
enumeration	2014																								
enumeration	2015																								
enumeration	2016																								

element **Intervento_Ricupero_Patrimonio_Edilizio_Type/Periodo**

diagram											
namespace	urn:www.agenziaentrate.gov.it:specificheTecniche:sco:p73										
type	p73:Periodo_Spese_Ristrutturazione_Type										
facets	<table border="0"> <tr> <td>Kind</td> <td>Value</td> </tr> <tr> <td>pattern</td> <td>[1-9]</td> </tr> <tr> <td>enumeration</td> <td>2</td> </tr> <tr> <td>enumeration</td> <td>3</td> </tr> <tr> <td>enumeration</td> <td>4</td> </tr> </table>	Kind	Value	pattern	[1-9]	enumeration	2	enumeration	3	enumeration	4
Kind	Value										
pattern	[1-9]										
enumeration	2										
enumeration	3										
enumeration	4										

element Intervento_Ricupero_Patrimonio_Edilizio_Type/CodiceFiscale

diagram					
namespace	urn:www.agenziaentrate.gov.it:specificheTecniche:sco:p73				
type	DatoCF_Type				
facets	<table border="1"> <thead> <tr> <th>Kind</th> <th>Value</th> </tr> </thead> <tbody> <tr> <td>pattern</td> <td>[0-9]{11}[A-Z]{6}[0-9LMNPQRSTUWV]{2}[A-Z]{1}[0-9LMNPQRSTUWV]{2}[A-Z]{1}[0-9LMNPQRSTUWV]{3}[A-Z]{1}</td> </tr> </tbody> </table>	Kind	Value	pattern	[0-9]{11}[A-Z]{6}[0-9LMNPQRSTUWV]{2}[A-Z]{1}[0-9LMNPQRSTUWV]{2}[A-Z]{1}[0-9LMNPQRSTUWV]{3}[A-Z]{1}
Kind	Value				
pattern	[0-9]{11}[A-Z]{6}[0-9LMNPQRSTUWV]{2}[A-Z]{1}[0-9LMNPQRSTUWV]{2}[A-Z]{1}[0-9LMNPQRSTUWV]{3}[A-Z]{1}				

element Intervento_Ricupero_Patrimonio_Edilizio_Type/CasellaInterventiParticolari

diagram									
namespace	urn:www.agenziaentrate.gov.it:specificheTecniche:sco:p73								
type	restriction of DatoN1_Type								
facets	<table border="1"> <thead> <tr> <th>Kind</th> <th>Value</th> </tr> </thead> <tbody> <tr> <td>pattern</td> <td>[1-9]</td> </tr> <tr> <td>enumeration</td> <td>1</td> </tr> <tr> <td>enumeration</td> <td>4</td> </tr> </tbody> </table>	Kind	Value	pattern	[1-9]	enumeration	1	enumeration	4
Kind	Value								
pattern	[1-9]								
enumeration	1								
enumeration	4								

element Intervento_Ricupero_Patrimonio_Edilizio_Type/CodiceSituazioniParticolari

diagram							
namespace	urn:www.agenziaentrate.gov.it:specificheTecniche:sco:p73						
type	p73:Casella_Codice_Type						
facets	<table border="1"> <thead> <tr> <th>Kind</th> <th>Value</th> </tr> </thead> <tbody> <tr> <td>pattern</td> <td>[1-9]</td> </tr> <tr> <td>enumeration</td> <td>4</td> </tr> </tbody> </table>	Kind	Value	pattern	[1-9]	enumeration	4
Kind	Value						
pattern	[1-9]						
enumeration	4						

element Intervento_Ricupero_Patrimonio_Edilizio_Type/Rate10

diagram																									
namespace	urn:www.agenziaentrate.gov.it:specificheTecniche:sco:p73																								
type	p73:Rate10_Type																								
facets	<table border="1"> <thead> <tr> <th>Kind</th> <th>Value</th> </tr> </thead> <tbody> <tr> <td>pattern</td> <td>[1-9]{1}[0-9]*</td> </tr> <tr> <td>enumeration</td> <td>1</td> </tr> <tr> <td>enumeration</td> <td>2</td> </tr> <tr> <td>enumeration</td> <td>3</td> </tr> <tr> <td>enumeration</td> <td>4</td> </tr> <tr> <td>enumeration</td> <td>5</td> </tr> <tr> <td>enumeration</td> <td>6</td> </tr> <tr> <td>enumeration</td> <td>7</td> </tr> <tr> <td>enumeration</td> <td>8</td> </tr> <tr> <td>enumeration</td> <td>9</td> </tr> <tr> <td>enumeration</td> <td>10</td> </tr> </tbody> </table>	Kind	Value	pattern	[1-9]{1}[0-9]*	enumeration	1	enumeration	2	enumeration	3	enumeration	4	enumeration	5	enumeration	6	enumeration	7	enumeration	8	enumeration	9	enumeration	10
Kind	Value																								
pattern	[1-9]{1}[0-9]*																								
enumeration	1																								
enumeration	2																								
enumeration	3																								
enumeration	4																								
enumeration	5																								
enumeration	6																								
enumeration	7																								
enumeration	8																								
enumeration	9																								
enumeration	10																								

element **Intervento_Ricupero_Patrimonio_Edilizio_Type/Spesa**

diagram	
namespace	urn:www.agenziaentrate.gov.it:specificheTecniche:sco:p73
type	DatoNP_Type
facets	Kind Value pattern [1-9]{1}[0-9]*

element **Intervento_Ricupero_Patrimonio_Edilizio_Type/NOrdineImmobile**

diagram	
namespace	urn:www.agenziaentrate.gov.it:specificheTecniche:sco:p73
type	DatoNP_Type
facets	Kind Value pattern [1-9]{1}[0-9]*

complexType **Intervento_Risparmio_Energetico_Type**

diagram	
namespace	urn:www.agenziaentrate.gov.it:specificheTecniche:sco:p73
children	p73:TipolIntervento p73:Anno p73:Periodo2013 p73:CasiParticolari p73:RideterminazioneRate p73:RipartizioneRate p73:NumeroRata p73:Spesa

element **Intervento_Risparmio_Energetico_Type/TipolIntervento**

diagram	
namespace	urn:www.agenziaentrate.gov.it:specificheTecniche:sco:p73

type	p73:Tipo Intervento Type	
facets	Kind	Value
	pattern	[1-9]
	enumeration	1
	enumeration	2
	enumeration	3
	enumeration	4
	enumeration	5
	enumeration	6
	enumeration	7

element **Intervento_Risparmio_Energetico_Type/Anno**

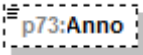
diagram		
namespace	urn:www.agenziaentrate.gov.it:specificheTecniche:sco:p73	
type	restriction of p73:Anno Risparmio Energetico Type	
facets	Kind	Value
	pattern	[1-9]{1}[0-9]*
	enumeration	2008
	enumeration	2011
	enumeration	2012
	enumeration	2013
	enumeration	2014
	enumeration	2015
	enumeration	2016

element **Intervento_Risparmio_Energetico_Type/Periodo2013**

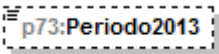
diagram		
namespace	urn:www.agenziaentrate.gov.it:specificheTecniche:sco:p73	
type	restriction of DatoN1 Type	
facets	Kind	Value
	pattern	[1-9]
	enumeration	1
	enumeration	2

element **Intervento_Risparmio_Energetico_Type/CasiParticolari**

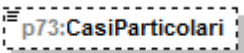
diagram		
namespace	urn:www.agenziaentrate.gov.it:specificheTecniche:sco:p73	
type	p73:Casi Particolari Risp Ener Type	
facets	Kind	Value
	pattern	[1-9]
	enumeration	1
	enumeration	2
	enumeration	3

element **Intervento_Risparmio_Energetico_Type/RideterminazioneRate**

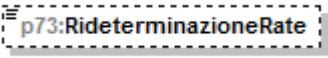
diagram																			
namespace	urn:www.agenziaentrate.gov.it:specificheTecniche:sco:p73																		
type	p73:Rate_Risparmio_Energetico_Type																		
facets	<table border="1"> <thead> <tr> <th>Kind</th> <th>Value</th> </tr> </thead> <tbody> <tr> <td>pattern</td> <td>[1-9]{1}[0-9]*</td> </tr> <tr> <td>enumeration</td> <td>4</td> </tr> <tr> <td>enumeration</td> <td>5</td> </tr> <tr> <td>enumeration</td> <td>6</td> </tr> <tr> <td>enumeration</td> <td>7</td> </tr> <tr> <td>enumeration</td> <td>8</td> </tr> <tr> <td>enumeration</td> <td>9</td> </tr> <tr> <td>enumeration</td> <td>10</td> </tr> </tbody> </table>	Kind	Value	pattern	[1-9]{1}[0-9]*	enumeration	4	enumeration	5	enumeration	6	enumeration	7	enumeration	8	enumeration	9	enumeration	10
Kind	Value																		
pattern	[1-9]{1}[0-9]*																		
enumeration	4																		
enumeration	5																		
enumeration	6																		
enumeration	7																		
enumeration	8																		
enumeration	9																		
enumeration	10																		

element **Intervento_Risparmio_Energetico_Type/RipartizioneRate**

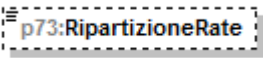
diagram									
namespace	urn:www.agenziaentrate.gov.it:specificheTecniche:sco:p73								
type	p73:Ripart_Risparmio_Energetico_Type								
facets	<table border="1"> <thead> <tr> <th>Kind</th> <th>Value</th> </tr> </thead> <tbody> <tr> <td>pattern</td> <td>[1-9]{1}[0-9]*</td> </tr> <tr> <td>enumeration</td> <td>9</td> </tr> <tr> <td>enumeration</td> <td>10</td> </tr> </tbody> </table>	Kind	Value	pattern	[1-9]{1}[0-9]*	enumeration	9	enumeration	10
Kind	Value								
pattern	[1-9]{1}[0-9]*								
enumeration	9								
enumeration	10								

element **Intervento_Risparmio_Energetico_Type/NumeroRata**

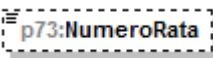
diagram																			
namespace	urn:www.agenziaentrate.gov.it:specificheTecniche:sco:p73																		
type	p73:Numero_Rata_Risparmio_Energetico_Type																		
facets	<table border="1"> <thead> <tr> <th>Kind</th> <th>Value</th> </tr> </thead> <tbody> <tr> <td>pattern</td> <td>[1-9]{1}[0-9]*</td> </tr> <tr> <td>enumeration</td> <td>1</td> </tr> <tr> <td>enumeration</td> <td>2</td> </tr> <tr> <td>enumeration</td> <td>3</td> </tr> <tr> <td>enumeration</td> <td>4</td> </tr> <tr> <td>enumeration</td> <td>5</td> </tr> <tr> <td>enumeration</td> <td>6</td> </tr> <tr> <td>enumeration</td> <td>9</td> </tr> </tbody> </table>	Kind	Value	pattern	[1-9]{1}[0-9]*	enumeration	1	enumeration	2	enumeration	3	enumeration	4	enumeration	5	enumeration	6	enumeration	9
Kind	Value																		
pattern	[1-9]{1}[0-9]*																		
enumeration	1																		
enumeration	2																		
enumeration	3																		
enumeration	4																		
enumeration	5																		
enumeration	6																		
enumeration	9																		

element **Intervento_Risparmio_Energetico_Type/Spesa**

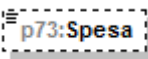
diagram					
namespace	urn:www.agenziaentrate.gov.it:specificheTecniche:sco:p73				
type	DatoNP_Type				
facets	<table border="1"> <thead> <tr> <th>Kind</th> <th>Value</th> </tr> </thead> <tbody> <tr> <td>pattern</td> <td>[1-9]{1}[0-9]*</td> </tr> </tbody> </table>	Kind	Value	pattern	[1-9]{1}[0-9]*
Kind	Value				
pattern	[1-9]{1}[0-9]*				

complexType Iva_Acquisto_Abitazione_Type

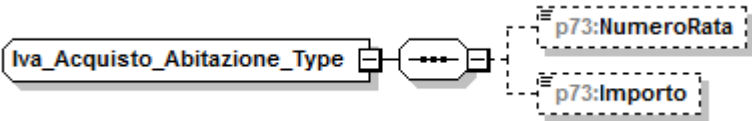
diagram	
namespace	urn:www.agenziaentrate.gov.it:specificheTecniche:sco:p73
children	p73:NumeroRata p73:Importo

element Iva_Acquisto_Abitazione_Type/NumeroRata

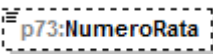
diagram							
namespace	urn:www.agenziaentrate.gov.it:specificheTecniche:sco:p73						
type	restriction of DatoNP_Type						
facets	<table border="0"> <tr> <td>Kind</td> <td>Value</td> </tr> <tr> <td>pattern</td> <td>[1-9]{1}[0-9]*</td> </tr> <tr> <td>enumeration</td> <td>1</td> </tr> </table>	Kind	Value	pattern	[1-9]{1}[0-9]*	enumeration	1
Kind	Value						
pattern	[1-9]{1}[0-9]*						
enumeration	1						

element Iva_Acquisto_Abitazione_Type/Importo

diagram					
namespace	urn:www.agenziaentrate.gov.it:specificheTecniche:sco:p73				
type	DatoNP_Type				
facets	<table border="0"> <tr> <td>Kind</td> <td>Value</td> </tr> <tr> <td>pattern</td> <td>[1-9]{1}[0-9]*</td> </tr> </table>	Kind	Value	pattern	[1-9]{1}[0-9]*
Kind	Value				
pattern	[1-9]{1}[0-9]*				

complexType Lavoro_Dipendente_Type

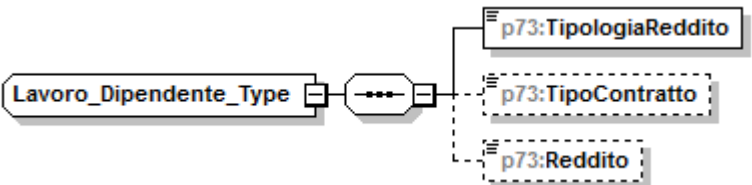
diagram	
namespace	urn:www.agenziaentrate.gov.it:specificheTecniche:sco:p73
children	p73:TipologiaReddito p73:TipoContratto p73:Reddito

element Lavoro_Dipendente_Type/TipologiaReddito

diagram	
---------	---

namespace	urn:www.agenziaentrate.gov.it:specificheTecniche:sco:p73	
type	p73:Tipo_Reddito_Da1a6_Type	
facets	Kind	Value
	pattern	[1-9]
	enumeration	1
	enumeration	2
	enumeration	3
	enumeration	4
	enumeration	5
	enumeration	6

element **Lavoro_Dipendente_Type/TipoContratto**

diagram		
namespace	urn:www.agenziaentrate.gov.it:specificheTecniche:sco:p73	
type	p73:Indeterminato_Determinato_Type	
facets	Kind	Value
	pattern	[1-9]
	enumeration	1
	enumeration	2

element **Lavoro_Dipendente_Type/Reddito**

diagram		
namespace	urn:www.agenziaentrate.gov.it:specificheTecniche:sco:p73	
type	DatoNP_Type	
facets	Kind	Value
	pattern	[1-9]{1}[0-9]*

complexType **Misura_Acconti_Type**

diagram		
namespace	urn:www.agenziaentrate.gov.it:specificheTecniche:sco:p73	
children	p73:IrpefMisuralInferiore p73:AddComunaleMisuralInferiore p73:CedolareSeccaMisuralInferiore p73:NumeroRate	

element Misura_Acconti_Type/IrpefMisuralInferiore

diagram	<p>The diagram shows a container element p73:Casella_Acconto_Type (yellow dashed box) containing two child elements: p73:Casella and p73:ImportoMisuralInferiore (both in dashed boxes). A parent element p73:IrpefMisuralInferiore (dashed box) is connected to the container via a composition relationship (hexagon with a plus sign).</p>
namespace	urn:www.agenziaentrate.gov.it:specificheTecniche:sco:p73
type	p73:Casella_Acconto_Type
children	p73:Casella p73:ImportoMisuralInferiore

element Misura_Acconti_Type/AddComunaleMisuralInferiore

diagram	<p>The diagram shows a container element p73:Casella_Acconto_Type (yellow dashed box) containing two child elements: p73:Casella and p73:ImportoMisuralInferiore (both in dashed boxes). A parent element p73:AddComunaleMisuralInferiore (dashed box) is connected to the container via a composition relationship (hexagon with a plus sign).</p>
namespace	urn:www.agenziaentrate.gov.it:specificheTecniche:sco:p73
type	p73:Casella_Acconto_Type
children	p73:Casella p73:ImportoMisuralInferiore

element Misura_Acconti_Type/CedolareSeccaMisuralInferiore

diagram	<p>The diagram shows a container element p73:Casella_Acconto_Type (yellow dashed box) containing two child elements: p73:Casella and p73:ImportoMisuralInferiore (both in dashed boxes). A parent element p73:CedolareSeccaMisuralInferiore (dashed box) is connected to the container via a composition relationship (hexagon with a plus sign).</p>
namespace	urn:www.agenziaentrate.gov.it:specificheTecniche:sco:p73
type	p73:Casella_Acconto_Type
children	p73:Casella p73:ImportoMisuralInferiore

element Misura_Acconti_Type/NumeroRate

diagram	<p>The diagram shows a single element p73:NumeroRate (dashed box).</p>
namespace	urn:www.agenziaentrate.gov.it:specificheTecniche:sco:p73
type	restriction of DatoN1_Type

facets	Kind	Value
	pattern	[1-9]
	enumeration	2
	enumeration	3
	enumeration	4
	enumeration	5
	enumeration	6
	enumeration	7

complexType Modulo_Altri_Reddito_Type

diagram	
namespace	urn:www.agenziaentrate.gov.it:specificheTecniche:sco:p73
children	p73:RedditiDiCapitale p73:RedditiTassazioneSeparata

element Modulo_Altri_Reddito_Type/RedditiDiCapitale

diagram	
namespace	urn:www.agenziaentrate.gov.it:specificheTecniche:sco:p73
type	p73:Redditi_Capitale_Type
children	p73:Utili p73:AltriRedditiDiCapitale p73:LavoroAutonomo p73:RedditiDiversi p73:RedditiDiversiDetraz

element Modulo_Altri_Reddito_Type/RedditiTassazioneSeparata

diagram	
namespace	urn:www.agenziaentrate.gov.it:specificheTecniche:sco:p73
type	p73:Redditi_Tassazione_Separata_Type

children	p73:RedditiErede p73:ImposteRimborsate
----------	--

complexType **Modulo_Crediti_Imposta_Type**

diagram	
namespace	urn:www.agenziaentrate.gov.it:specificheTecniche:sco:p73
children	p73:CreditiImpostaFondiPensione p73:CreditiImpostaRedditiEsteri p73:CreditoPrimaCasaSismaAbruzzo p73:CreditoAltriSismaAbruzzo p73:CreditoNegoziazione

element **Modulo_Crediti_Imposta_Type/CreditiImpostaFondiPensione**

diagram	
namespace	urn:www.agenziaentrate.gov.it:specificheTecniche:sco:p73
type	p73:Crediti Imposta Fondi Pensione Type
children	p73:AnnoAnticipazione p73:Reintegro p73:SommaReintegrata p73:CreditoAnno

element **Modulo_Crediti_Imposta_Type/CreditiImpostaRedditiEsteri**

<p>diagram</p>	
<p>namespace</p>	<p>urn:www.agenziaentrate.gov.it:specificheTecniche:sco:p73</p>
<p>type</p>	<p>p73:Crediti_Imposta_Redditi_Esteri_Type</p>
<p>children</p>	<p>p73:StatoEestero p73:Anno p73:RedditoEestero p73:ImpostaEstera p73:RedditoComplessivo p73:Imposta_Lorda p73:ImpostaNetta p73:CreditoDichiarazioniPrecedenti p73:DiCuiStatoEestero</p>

element **Modulo_Crediti_Imposta_Type/CreditoPrimaCasaSismaAbruzzo**

<p>diagram</p>	
<p>namespace</p>	<p>urn:www.agenziaentrate.gov.it:specificheTecniche:sco:p73</p>
<p>type</p>	<p>p73:Credito_Immobile_Sisma_Abruzzo_Type</p>
<p>children</p>	<p>p73:CodiceFiscale p73:NumeroRata p73:TotaleCredito</p>

element **Modulo_Crediti_Imposta_Type/CreditoAltriSismaAbruzzo**

diagram	
namespace	urn:www.agenziaentrate.gov.it:specificheTecniche:sco:p73
type	p73:Crediti_Imposta_Altri_Sisma_Abruzzo_Type
children	p73:Impresa_Professione p73:CreditoImmobileSismaAbruzzo p73:Rateazione

element **Modulo_Crediti_Imposta_Type/CreditoNegoziazione**

diagram	
namespace	urn:www.agenziaentrate.gov.it:specificheTecniche:sco:p73
type	p73:Modulo_Credito_Negoziiazione_Type
children	p73:CreditoSpettante

complexType **Modulo_Credito_Negoziiazione_Type**

diagram	
namespace	urn:www.agenziaentrate.gov.it:specificheTecniche:sco:p73
children	p73:CreditoSpettante

element **Modulo_Credito_Negoziiazione_Type/CreditoSpettante**

diagram					
namespace	urn:www.agenziaentrate.gov.it:specificheTecniche:sco:p73				
type	DatoNP_Type				
facets	<table border="1"> <thead> <tr> <th>Kind</th> <th>Value</th> </tr> </thead> <tbody> <tr> <td>pattern</td> <td>[1-9]{1}[0-9]*</td> </tr> </tbody> </table>	Kind	Value	pattern	[1-9]{1}[0-9]*
Kind	Value				
pattern	[1-9]{1}[0-9]*				

complexType **Modulo_Fabbricato_Type**

diagram	
namespace	urn:www.agenziaentrate.gov.it:specificheTecniche:sco:p73
children	p73:FabbricatoOrd p73:FabbricatoAgev

element **Modulo_Fabbricato_Type/FabbricatoOrd**

diagram	
namespace	urn:www.agenziaentrate.gov.it:specificheTecniche:sco:p73
type	p73:Fabbricato_Ord_Type
children	p73:Rendita p73:Utilizzo p73:GiorniPossesso p73:PercPossesso p73:CodiceCanone p73:CanoneLocazione p73:CasiParticolari p73:CasellaContinuazione p73:CodiceComune p73:OpzioneCedolare p73:CasellaCasiPartImu

element **Modulo_Fabbricato_Type/FabbricatoAgev**

diagram	
namespace	urn:www.agenziaentrate.gov.it:specificheTecniche:sco:p73
type	p73:Fabbricato_Agev_Type
children	p73:NumeroRigoRiferimento p73:NumModuloRiferimento p73:DatiContratto p73:CasellaInf30Giorni p73:AnnoDichiarazioneIcilmu p73:StatoEmergenza

complexType **Modulo_Familiari_Type**

diagram	
namespace	urn:www.agenziaentrate.gov.it:specificheTecniche:sco:p73
children	p73:Coniuge p73:PrimoFiglio p73:Familiari

element **Modulo_Familiari_Type/Coniuge**

diagram	
namespace	urn:www.agenziaentrate.gov.it:specificheTecniche:sco:p73
type	p73:Dati_Coniuge_Type

element **Modulo_Familiari_Type/Familiari**

diagram	
namespace	urn:www.agenziaentrate.gov.it:specificheTecniche:sco:p73
type	extension of p73:Dati_Familiare_Type
children	p73:CodiceFiscale p73:Mesi p73:MesiMinore p73:PercDetraz p73:PercDetrazCon p73:Affidamento p73:Tipo

element **Modulo_Familiari_Type/Familiari/Tipo**

diagram											
namespace	urn:www.agenziaentrate.gov.it:specificheTecniche:sco:p73										
type	restriction of DatoAN_Type										
facets	<table border="0"> <tr> <td>Kind</td> <td>Value</td> </tr> <tr> <td>pattern</td> <td>([0-9A-Z\-\]&quot;){1}([0-9A-Z&amp;] \- \., /°\^\\(\) À É Ê Ï Ò Ù Ü &quot;;\ \\ +)*</td> </tr> <tr> <td>enumeration</td> <td>F</td> </tr> <tr> <td>enumeration</td> <td>D</td> </tr> <tr> <td>enumeration</td> <td>A</td> </tr> </table>	Kind	Value	pattern	([0-9A-Z\-\]"){1}([0-9A-Z&] \- \., /°\^\\(\) À É Ê Ï Ò Ù Ü ";\ \\ +)*	enumeration	F	enumeration	D	enumeration	A
Kind	Value										
pattern	([0-9A-Z\-\]"){1}([0-9A-Z&] \- \., /°\^\\(\) À É Ê Ï Ò Ù Ü ";\ \\ +)*										
enumeration	F										
enumeration	D										
enumeration	A										

complexType **Modulo_Lavoro_Dip_Type**

diagram	
namespace	urn:www.agenziaentrate.gov.it:specificheTecniche:sco:p73

children	p73:LavoroDipendente p73:PremiRisultato p73:AltriRedditiAssLavDip p73:Bonuslrpef
----------	--

element **Modulo_Lavoro_Dip_Type/LavoroDipendente**

diagram	
namespace	urn:www.agenziaentrate.gov.it:specificheTecniche:sco:p73
type	p73:Lavoro_Dipendente_Type
children	p73:TipologiaReddito p73:TipoContratto p73:Reddito

element **Modulo_Lavoro_Dip_Type/PremiRisultato**

diagram	
namespace	urn:www.agenziaentrate.gov.it:specificheTecniche:sco:p73
type	p73:Premi_Risultato_Modulo_Type
children	p73:TipoLimite p73:ImportoTassazOrdinaria p73:ImportoImpostaSostitutiva p73:RitenuteImpostaSostitutiva p73:Benefit

element **Modulo_Lavoro_Dip_Type/AltriRedditiAssLavDip**

diagram	
---------	--

namespace	urn:www.agenziaentrate.gov.it:specificheTecniche:sco:p73
type	p73:Altri_Reddito_Ass_Lav_Type
children	p73:AssegnoDelConiuge p73:ImportoRedditoAssimilato

element **Modulo_Lavoro_Dip_Type/BonusIrpef**

diagram	
namespace	urn:www.agenziaentrate.gov.it:specificheTecniche:sco:p73
children	p73:Esenzione

element **Modulo_Lavoro_Dip_Type/BonusIrpef/Esenzione**

diagram	
namespace	urn:www.agenziaentrate.gov.it:specificheTecniche:sco:p73
type	p73:Esenzione_Bonus_Type
children	p73:TipologiaEsenzione p73:ParteRedditoEsente

complexType **Modulo_Oneri_Type**

<p>diagram</p>	
<p>namespace</p>	<p>urn:www.agenziaentrate.gov.it:specificheTecniche:sco:p73</p>
<p>children</p>	<p>p73:SpeseDetrazioni p73:SpeseDeduzioni p73:InterventoRecuperoPatrimonioEdilizio p73:DatiCatastaliRecuperoPatrimonioEdilizio p73:InterventoRisparmioEnergetico p73:CanoniLocazione p73:DatiAltreDetrazioni p73:SpeseArredo p73:SpeseArredoGiovaniCoppie p73:IvaAcquistoAbitazione</p>

element **Modulo_Oneri_Type/SpeseDetrazioni**

<p>diagram</p>	
<p>namespace</p>	<p>urn:www.agenziaentrate.gov.it:specificheTecniche:sco:p73</p>
<p>type</p>	<p>p73:Detrazioni_Modulo_Type</p>
<p>children</p>	<p>p73:VeicoliDisabili p73:AcquistoCaniGuida p73:SpeseRateizzate p73:AltreSpese p73:SpeseLeasing</p>

element **Modulo_Oneri_Type/SpeseDeduzioni**

diagram	
namespace	urn:www.agenziaentrate.gov.it:specificheTecniche:sco:p73
type	p73:Deduzioni_Modulo_Type
children	p73:AssegnoConiuge p73:AltriOneri p73:AcquistoCostruzioneAbitLocazione

element **Modulo_Oneri_Type/InterventoRecuperoPatrimonioEdilizio**

diagram	
namespace	urn:www.agenziaentrate.gov.it:specificheTecniche:sco:p73
type	p73:Intervento_Ricupero_Patrimonio_Edilizio_Type
children	p73:Anno p73:Periodo p73:CodiceFiscale p73:CasellaInterventiParticolari p73:CodiceSituazioniParticolari p73:Rate10 p73:Spesa p73:NOrdineImmobile

element **Modulo_Oneri_Type/DatiCatastaliRecuperoPatrimonioEdilizio**

<p>diagram</p>	
<p>namespace</p>	<p>urn:www.agenziaentrate.gov.it:specificheTecniche:sco:p73</p>
<p>type</p>	<p>p73:Sezione Dati Catastali Recupero Patrimonio Edilizio Type</p>
<p>children</p>	<p>p73:DatiCatastaliRecuperoPatrimonioEdilizio p73:DatiRegistrazioneAccatamentoRecuperoPatrimonio Edilizio</p>

element **Modulo_Oneri_Type/InterventoRisparmioEnergetico**

<p>diagram</p>	
<p>namespace</p>	<p>urn:www.agenziaentrate.gov.it:specificheTecniche:sco:p73</p>
<p>type</p>	<p>p73:Intervento Risparmio Energetico Type</p>
<p>children</p>	<p>p73:TipoIntervento p73:Anno p73:Periodo2013 p73:CasiParticolari p73:RideterminazioneRate p73:RipartizioneRate p73:NumeroRata p73:Spesa</p>

element **Modulo_Oneri_Type/CanoniLocazione**

diagram	
namespace	urn:www.agenziaentrate.gov.it:specificheTecniche:sco:p73
type	p73:Detrazioni_Canoni_Locazione_Type
children	p73:InquiliniAbitazionePrincipale p73:DipendentiTrasferiti

element **Modulo_Oneri_Type/DatiAltreDetrazioni**

diagram	
namespace	urn:www.agenziaentrate.gov.it:specificheTecniche:sco:p73
type	p73:Dati_Altre_Detrazioni_Modulo_Type
children	p73:AltreDetrazioni

element **Modulo_Oneri_Type/SpeseArredo**

diagram	
namespace	urn:www.agenziaentrate.gov.it:specificheTecniche:sco:p73
type	p73:Spese_Arredo_Type
children	p73:NumeroRata p73:Importo

element **Modulo_Oneri_Type/SpeseArredoGiovaniCoppie**

diagram	
namespace	urn:www.agenziaentrate.gov.it:specificheTecniche:sco:p73
type	p73:Spese_Arredo_Giovani_Coppie_Type
children	p73:Meno35Anni p73:NumeroRata p73:Importo

element **Modulo_Oneri_Type/IvaAcquistoAbitazione**

diagram	
namespace	urn:www.agenziaentrate.gov.it:specificheTecniche:sco:p73
type	p73:Iva_Acquisto_Abitazione_Type
children	p73:NumeroRata p73:Importo

complexType **Modulo_PL_Type**

diagram	
namespace	urn:www.agenziaentrate.gov.it:specificheTecniche:sco:p73
children	p73:CredImpEstero

element **Modulo_PL_Type/CredImpEestero**

<p>diagram</p>	
<p>namespace</p>	<p>urn:www.agenziaentrate.gov.it:specificheTecniche:sco:p73</p>
<p>type</p>	<p>p73:Cred_Imp_Estero_Type</p>
<p>children</p>	<p>p73:Anno p73:TotCredito p73:CreditoStato</p>

complexType **Modulo_Terreno_Type**

<p>diagram</p>	
<p>namespace</p>	<p>urn:www.agenziaentrate.gov.it:specificheTecniche:sco:p73</p>
<p>children</p>	<p>p73:Terreno</p>

element **Modulo_Terreno_Type/Terreno**

diagram	
namespace	urn:www.agenziaentrate.gov.it:specificheTecniche:sco:p73
type	p73:Terreno_Type
children	p73:RedDominicale p73:Titolo p73:RedAgrario p73:GiorniPossesso p73:PercPossesso p73:CanoneVincolistico p73:CasiParticolari p73:CasellaContinuazione p73:CasellalmuNonDovuta p73:CasellaColtivatoreDiretto

complexType **N_Rate_Type**

diagram	
namespace	urn:www.agenziaentrate.gov.it:specificheTecniche:sco:p73
children	p73:Rate5

element **N_Rate_Type/Rate5**

diagram							
namespace	urn:www.agenziaentrate.gov.it:specificheTecniche:sco:p73						
type	p73:Rate5_Type						
facets	<table border="0"> <tr> <td>Kind</td> <td>Value</td> </tr> <tr> <td>pattern</td> <td>[1-9]{1}[0-9]*</td> </tr> <tr> <td>enumeration</td> <td>5</td> </tr> </table>	Kind	Value	pattern	[1-9]{1}[0-9]*	enumeration	5
Kind	Value						
pattern	[1-9]{1}[0-9]*						
enumeration	5						

complexType Oneri_Non_Abbattuti_Type

diagram	
namespace	urn:www.agenziaentrate.gov.it:specificheTecniche:sco:p73
children	p73:DetrazSpeseAssPersonale p73:DetrazErogazBiennaleVenezia p73:DetrazErogazSpettacolo p73:DetrazErogazSettoreMusicale p73:DeduzContributiPaesiSviluppo p73:DeduzOnlus p73:DetrazOspedaleGalliera p73:PrevidenzaComplDipPubblici p73:InteressiMutuiAgrari p73:DeduzTrust

element Oneri_Non_Abbattuti_Type/DetrazSpeseAssPersonale

diagram					
namespace	urn:www.agenziaentrate.gov.it:specificheTecniche:sco:p73				
type	DatoNP_Type				
facets	<table border="1"> <thead> <tr> <th>Kind</th> <th>Value</th> </tr> </thead> <tbody> <tr> <td>pattern</td> <td>[1-9]{1}[0-9]*</td> </tr> </tbody> </table>	Kind	Value	pattern	[1-9]{1}[0-9]*
Kind	Value				
pattern	[1-9]{1}[0-9]*				

element Oneri_Non_Abbattuti_Type/DetrazErogazBiennaleVenezia

diagram					
namespace	urn:www.agenziaentrate.gov.it:specificheTecniche:sco:p73				
type	DatoNP_Type				
facets	<table border="1"> <thead> <tr> <th>Kind</th> <th>Value</th> </tr> </thead> <tbody> <tr> <td>pattern</td> <td>[1-9]{1}[0-9]*</td> </tr> </tbody> </table>	Kind	Value	pattern	[1-9]{1}[0-9]*
Kind	Value				
pattern	[1-9]{1}[0-9]*				

element **Oneri_Non_Abbattuti_Type/DetrazErogazSpettacolo**

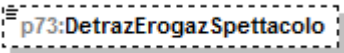
diagram					
namespace	urn:www.agenziaentrate.gov.it:specificheTecniche:sco:p73				
type	DatoNP_Type				
facets	<table border="1"> <tr> <td>Kind</td> <td>Value</td> </tr> <tr> <td>pattern</td> <td>[1-9]{1}[0-9]*</td> </tr> </table>	Kind	Value	pattern	[1-9]{1}[0-9]*
Kind	Value				
pattern	[1-9]{1}[0-9]*				

element **Oneri_Non_Abbattuti_Type/DetrazErogazSettoreMusicale**

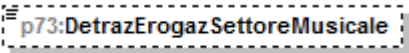
diagram					
namespace	urn:www.agenziaentrate.gov.it:specificheTecniche:sco:p73				
type	DatoNP_Type				
facets	<table border="1"> <tr> <td>Kind</td> <td>Value</td> </tr> <tr> <td>pattern</td> <td>[1-9]{1}[0-9]*</td> </tr> </table>	Kind	Value	pattern	[1-9]{1}[0-9]*
Kind	Value				
pattern	[1-9]{1}[0-9]*				

element **Oneri_Non_Abbattuti_Type/DeduzContributiPaesiSviluppo**

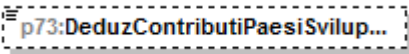
diagram					
namespace	urn:www.agenziaentrate.gov.it:specificheTecniche:sco:p73				
type	DatoNP_Type				
facets	<table border="1"> <tr> <td>Kind</td> <td>Value</td> </tr> <tr> <td>pattern</td> <td>[1-9]{1}[0-9]*</td> </tr> </table>	Kind	Value	pattern	[1-9]{1}[0-9]*
Kind	Value				
pattern	[1-9]{1}[0-9]*				

element **Oneri_Non_Abbattuti_Type/DeduzOnlus**

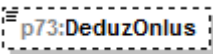
diagram					
namespace	urn:www.agenziaentrate.gov.it:specificheTecniche:sco:p73				
type	DatoNP_Type				
facets	<table border="1"> <tr> <td>Kind</td> <td>Value</td> </tr> <tr> <td>pattern</td> <td>[1-9]{1}[0-9]*</td> </tr> </table>	Kind	Value	pattern	[1-9]{1}[0-9]*
Kind	Value				
pattern	[1-9]{1}[0-9]*				

element **Oneri_Non_Abbattuti_Type/DetrazOspedaleGalliera**

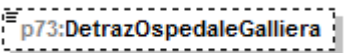
diagram					
namespace	urn:www.agenziaentrate.gov.it:specificheTecniche:sco:p73				
type	DatoNP_Type				
facets	<table border="1"> <tr> <td>Kind</td> <td>Value</td> </tr> <tr> <td>pattern</td> <td>[1-9]{1}[0-9]*</td> </tr> </table>	Kind	Value	pattern	[1-9]{1}[0-9]*
Kind	Value				
pattern	[1-9]{1}[0-9]*				

element Oneri_Non_Abbattuti_Type/PrevidenzaCompIDipPubblici

diagram	
namespace	urn:www.agenziaentrate.gov.it:specificheTecniche:sco:p73
type	DatoNP_Type
facets	Kind Value pattern [1-9]{1}[0-9]*

element Oneri_Non_Abbattuti_Type/InteressiMutuiAgrari

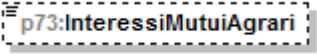
diagram	
namespace	urn:www.agenziaentrate.gov.it:specificheTecniche:sco:p73
type	DatoNP_Type
facets	Kind Value pattern [1-9]{1}[0-9]*

element Oneri_Non_Abbattuti_Type/DeduzTrust

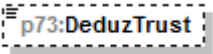
diagram	
namespace	urn:www.agenziaentrate.gov.it:specificheTecniche:sco:p73
type	DatoNP_Type
facets	Kind Value pattern [1-9]{1}[0-9]*

complexType Oneri_Type

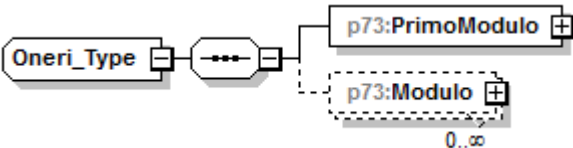
diagram	
namespace	urn:www.agenziaentrate.gov.it:specificheTecniche:sco:p73
children	p73:PrimoModulo p73:Modulo

element **Oneri_Type/PrimoModulo**

<p>diagram</p>	
<p>namespace</p>	<p>urn:www.agenziaentrate.gov.it:specificheTecniche:sco:p73</p>
<p>type</p>	<p>p73:Primo_Modulo_Oneri_Type</p>
<p>children</p>	<p>p73:SpeseDetrazioni p73:SpeseDeduzioni p73:InterventoRecuperoPatrimonioEdilizio p73:DatiCatastaliRecuperoPatrimonioEdilizio p73:InterventoRisparmioEnergetico p73:CanoniLocazione p73:DatiAltreDetrazioni p73:OneriNonAbbattuti p73:SpeseArredo p73:SpeseArredoGiovani p73:IvaAcquistoAbitazione</p>

element **Oneri_Type/Modulo**

<p>diagram</p>	
<p>namespace</p>	<p>urn:www.agenziaentrate.gov.it:specificheTecniche:sco:p73</p>
<p>type</p>	<p>p73:Modulo_Oneri_Type</p>
<p>children</p>	<p>p73:SpeseDetrazioni p73:SpeseDeduzioni p73:InterventoRecuperoPatrimonioEdilizio p73:DatiCatastaliRecuperoPatrimonioEdilizio p73:InterventoRisparmioEnergético p73:CanoniLocazione p73:DatiAltreDetrazioni p73:SpeseArredo p73:SpeseArredoGiovaniCoppie p73:IvaAcquistoAbitazione</p>

complexType **Opzione_Produttivita_Type**

<p>diagram</p>	
<p>namespace</p>	<p>urn:www.agenziaentrate.gov.it:specificheTecniche:sco:p73</p>

complexType **Periodo_Di_Lavoro_Type**

<p>diagram</p>	
<p>namespace</p>	<p>urn:www.agenziaentrate.gov.it:specificheTecniche:sco:p73</p>

children	p73:GiorniLavoroDipendente p73:GiorniPensione
----------	---

element Periodo_Di_Lavoro_Type/GiorniLavoroDipendente

diagram	
namespace	urn:www.agenziaentrate.gov.it:specificheTecniche:sco:p73
type	DatoGA Type
facets	Kind Value pattern [1-9]((1-9)[0-9])((12)[0-9][0-9])(3[0-5][0-9])(36[0-5])

element Periodo_Di_Lavoro_Type/GiorniPensione

diagram	
namespace	urn:www.agenziaentrate.gov.it:specificheTecniche:sco:p73
type	DatoGA Type
facets	Kind Value pattern [1-9]((1-9)[0-9])((12)[0-9][0-9])(3[0-5][0-9])(36[0-5])

complexType Premi_Risultato_Modulo_Type

diagram	
namespace	urn:www.agenziaentrate.gov.it:specificheTecniche:sco:p73
children	p73:TipoLimite p73:ImportoTassazOrdinaria p73:ImportoImpostaSostitutiva p73:RitenuteImpostaSostitutiva p73:Benefit

element Premi_Risultato_Modulo_Type/TipoLimite

diagram	
namespace	urn:www.agenziaentrate.gov.it:specificheTecniche:sco:p73
type	restriction of DatoN1 Type
facets	Kind Value pattern [1-9] enumeration 1 enumeration 2

element **Premi_Risultato_Modulo_Type/ImportoTassazOrdinaria**

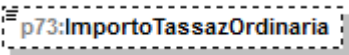
diagram					
namespace	urn:www.agenziaentrate.gov.it:specificheTecniche:sco:p73				
type	DatoNP_Type				
facets	<table border="1"> <tr> <td>Kind</td> <td>Value</td> </tr> <tr> <td>pattern</td> <td>[1-9]{1}[0-9]*</td> </tr> </table>	Kind	Value	pattern	[1-9]{1}[0-9]*
Kind	Value				
pattern	[1-9]{1}[0-9]*				

element **Premi_Risultato_Modulo_Type/ImportoImpostaSostitutiva**

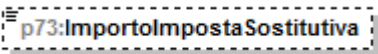
diagram					
namespace	urn:www.agenziaentrate.gov.it:specificheTecniche:sco:p73				
type	DatoNP_Type				
facets	<table border="1"> <tr> <td>Kind</td> <td>Value</td> </tr> <tr> <td>pattern</td> <td>[1-9]{1}[0-9]*</td> </tr> </table>	Kind	Value	pattern	[1-9]{1}[0-9]*
Kind	Value				
pattern	[1-9]{1}[0-9]*				

element **Premi_Risultato_Modulo_Type/RitenuteImpostaSostitutiva**

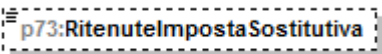
diagram					
namespace	urn:www.agenziaentrate.gov.it:specificheTecniche:sco:p73				
type	DatoNP_Type				
facets	<table border="1"> <tr> <td>Kind</td> <td>Value</td> </tr> <tr> <td>pattern</td> <td>[1-9]{1}[0-9]*</td> </tr> </table>	Kind	Value	pattern	[1-9]{1}[0-9]*
Kind	Value				
pattern	[1-9]{1}[0-9]*				

element **Premi_Risultato_Modulo_Type/Benefit**

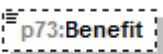
diagram					
namespace	urn:www.agenziaentrate.gov.it:specificheTecniche:sco:p73				
type	DatoNP_Type				
facets	<table border="1"> <tr> <td>Kind</td> <td>Value</td> </tr> <tr> <td>pattern</td> <td>[1-9]{1}[0-9]*</td> </tr> </table>	Kind	Value	pattern	[1-9]{1}[0-9]*
Kind	Value				
pattern	[1-9]{1}[0-9]*				

complexType **Premi_Risultato_Type**

diagram	
namespace	urn:www.agenziaentrate.gov.it:specificheTecniche:sco:p73
type	extension of p73:Premi_Risultato_Modulo_Type
children	p73:TipoLimite p73:ImportoTassazOrdinaria p73:ImportoImpostaSostitutiva p73:RitenuteImpostaSostitutiva p73:Benefit p73:TassazOrdinaria p73:TassazSostitutiva

element **Premi_Risultato_Type/TassazOrdinaria**

diagram					
namespace	urn:www.agenziaentrate.gov.it:specificheTecniche:sco:p73				
type	DatoCB_Type				
facets	<table border="1"> <thead> <tr> <th>Kind</th> <th>Value</th> </tr> </thead> <tbody> <tr> <td>pattern</td> <td>[01]</td> </tr> </tbody> </table>	Kind	Value	pattern	[01]
Kind	Value				
pattern	[01]				

element **Premi_Risultato_Type/TassazSostitutiva**

diagram					
namespace	urn:www.agenziaentrate.gov.it:specificheTecniche:sco:p73				
type	DatoCB_Type				
facets	<table border="1"> <thead> <tr> <th>Kind</th> <th>Value</th> </tr> </thead> <tbody> <tr> <td>pattern</td> <td>[01]</td> </tr> </tbody> </table>	Kind	Value	pattern	[01]
Kind	Value				
pattern	[01]				

complexType **Primo_Modulo_Acconti_Ritenute_Type**

<p>diagram</p>	
<p>namespace</p>	<p>urn:www.agenziaentrate.gov.it:specificheTecniche:sco:p73</p>
<p>children</p>	<p>p73:Accontilrpef p73:AltreRitenute p73:Eccedenze p73:EccedenzeOltreAnno p73:RitenuteAccontiSospesi p73:MisuraAcconti p73:EsenzioneAddComunale p73:Dati730Integrativo p73:AccontiAltriDati</p>

element **Primo_Modulo_Acconti_Ritenute_Type/Accontilrpef**

<p>diagram</p>	
<p>namespace</p>	<p>urn:www.agenziaentrate.gov.it:specificheTecniche:sco:p73</p>
<p>type</p>	<p>p73:Acconti_Irpef_Anno_Imposta_Type</p>
<p>children</p>	<p>p73:PrimaRataAccontilrpef p73:SecondaRataAccontilrpef p73:AccontoAddComunale p73:PrimaRataAccontoCedolare p73:SecondaRataAccontoCedolare</p>

element **Primo_Modulo_Aconti_Ritenute_Type/AltreRitenute**

<p>diagram</p>	
<p>namespace</p>	<p>urn:www.agenziaentrate.gov.it:specificheTecniche:sco:p73</p>
<p>type</p>	<p>p73:Altre Ritenute Type</p>
<p>children</p>	<p>p73:Codice p73:AltreRitenuteIrpef p73:AddizionaleRegionale p73:AddizionaleComunale p73:AddRegionaleIrpefAttivitaSport p73:AddComunaleIrpefAttivitaSport p73:IrpefLavoriSocialmenteUtili p73:AddRegionaleIrpefLavoriSoc Utili</p>

element **Primo_Modulo_Acconti_Ritenute_Type/Eccedenze**

<p>diagram</p>	
<p>namespace</p>	<p>urn:www.agenziaentrate.gov.it:specificheTecniche:sco:p73</p>
<p>type</p>	<p>p73:Eccedenze_Type</p>
<p>children</p>	<p>p73:lrpef p73:lrpefCompF24 p73:SostitutivaQuadroRT p73:SostitutivaQuadroRTcompF24 p73:CedolareSecca p73:CedolareSeccaCompF24 p73:CodiceRegione p73:AddRegionalelrpef p73:AddRegionalelrpefCompF24 p73:CodiceCatastaleComune p73:AddComunalelrpef p73:AddComunalelrpefF24</p>

element **Primo_Modulo_Acconti_Ritenute_Type/EccedenzeOltreAnno**

<p>diagram</p>	
<p>namespace</p>	<p>urn:www.agenziaentrate.gov.it:specificheTecniche:sco:p73</p>
<p>type</p>	<p>p73:Eccedenze Oltre Anno Type</p>
<p>children</p>	<p>p73:Anno p73:lrpef p73:SostitutivaQuadroRT p73:CedolareSecca p73:CodiceRegione p73:AddRegionalelrpef p73:CodiceCatastaleComune p73:AddComunalelrpef p73:ImpostaSostitutiva</p>

element **Primo_Modulo_Acconti_Ritenute_Type/RitenuteAccontiSospesi**

<p>diagram</p>	
<p>namespace</p>	<p>urn:www.agenziaentrate.gov.it:specificheTecniche:sco:p73</p>
<p>type</p>	<p>p73:Ritenute Acconti Sospesi Type</p>

children	p73:CodiceEvento p73:Irpef p73:AddRegionaleIrpef p73:AddComunaleIrpef p73:SostitutivaPremi p73:CedolareSecca p73:ContribSolidarieta
----------	--

element Primo_Modulo_Acconti_Ritenute_Type/MisuraAcconti

diagram	
namespace	urn:www.agenziaentrate.gov.it:specificheTecniche:sco:p73
type	p73:Misura_Acconti_Type
children	p73:IrpefMisuralInferiore p73:AddComunaleMisuralInferiore p73:CedolareSeccaMisuralInferiore p73:NumeroRate

element Primo_Modulo_Acconti_Ritenute_Type/EsenzioneAddComunale

diagram	
namespace	urn:www.agenziaentrate.gov.it:specificheTecniche:sco:p73
type	p73:Esenzione_Add_Comunale_Type
children	p73:SogliaEsenzioneSaldo p73:SogliaEsenzioneAcconto

element Primo_Modulo_Acconti_Ritenute_Type/Dati730Integrativo

diagram	
namespace	urn:www.agenziaentrate.gov.it:specificheTecniche:sco:p73
type	p73:Dati_730_Integrativo_Type
children	p73:Rimborso p73:Credito

element **Primo_Modulo_Acconti_Ritenute_Type/AccontiAltriDati**

<p>diagram</p>	
<p>namespace</p>	<p>urn:www.agenziaentrate.gov.it:specificheTecniche:sco:p73</p>
<p>type</p>	<p>p73:Acconti_Altri_Dati_Type</p>
<p>children</p>	<p>p73:IncapientiDetrazioneFigli p73:IncapientiDetrazioneLocazione p73:RestituzioneBonusFiscale p73:RestituzioneBonusStraordinario p73:Pignoramento</p>

complexType **Primo_Modulo_Crediti_Imposta_Type**

<p>diagram</p>	
<p>namespace</p>	<p>urn:www.agenziaentrate.gov.it:specificheTecniche:sco:p73</p>
<p>children</p>	<p>p73:CreditoImpostaFabbricati p73:CreditoImpostaFondiPensione p73:CreditoImpostaRedditiEsteri p73:CreditoPrimaCasaSismaAbruzzo p73:CreditoAltriSismaAbruzzo p73:CreditoIncrementoOccupazione p73:CreditoImpostaMediazioni p73:CreditoErogazioniCultura p73:CreditoNegoziazione p73:CreditoErogazioniScuola p73:CreditoVideosorveglianza</p>

p73:CreditoErogazioniScuola p73:CreditoVideosorveglianza
--

element **Primo_Modulo_Crediti_Imposta_Type/CreditiImpostaFabbricati**

diagram	<p>The diagram shows a dashed box labeled 'p73:Crediti_Imposta_Fabbricati_Type' containing two sub-elements: 'p73:ResiduoFabbricati' and 'p73:CanoniLocazioneNonPercepiti'. To the left, a dashed box labeled 'p73:CreditiImpostaFabbricati' is connected to the main type box via a connector.</p>
namespace	urn:www.agenziaentrate.gov.it:specificheTecniche:sco:p73
type	p73:Crediti_Imposta_Fabbricati_Type
children	p73:ResiduoFabbricati p73:CanoniLocazioneNonPercepiti

element **Primo_Modulo_Crediti_Imposta_Type/CreditiImpostaFondiPensione**

diagram	<p>The diagram shows a dashed box labeled 'p73:Crediti_Imposta_Fondi_Pensione_Type (extension)' containing six sub-elements: 'p73:AnnoAnticipazione', 'p73:Reintegro', 'p73:SommaReintegrata', 'p73:CreditoAnno', 'p73:ResiduoPrecedenteDichiara...', and 'p73:DiCuiCompensatoF24'. To the left, a dashed box labeled 'p73:CreditiImpostaFondiPensio...' is connected to the main type box via a connector.</p>
namespace	urn:www.agenziaentrate.gov.it:specificheTecniche:sco:p73
type	extension of p73:Crediti_Imposta_Fondi_Pensione_Type
children	p73:AnnoAnticipazione p73:Reintegro p73:SommaReintegrata p73:CreditoAnno p73:ResiduoPrecedenteDichiarazione p73:DiCuiCompensatoF24

element **Primo_Modulo_Crediti_Imposta_Type/CreditiImpostaFondiPensione/ResiduoPrecedenteDichiarazione**

diagram	<p>The diagram shows a single dashed box labeled 'p73:ResiduoPrecedenteDichiara...'.</p>				
namespace	urn:www.agenziaentrate.gov.it:specificheTecniche:sco:p73				
type	DatoNP_Type				
facets	<table border="1"> <tr> <td>Kind</td> <td>Value</td> </tr> <tr> <td>pattern</td> <td>[1-9]{1}[0-9]*</td> </tr> </table>	Kind	Value	pattern	[1-9]{1}[0-9]*
Kind	Value				
pattern	[1-9]{1}[0-9]*				

element **Primo_Modulo_Crediti_Imposta_Type/CreditImpostaFondiPensione/DiCuiCompensatoF24**

diagram	
namespace	urn:www.agenziaentrate.gov.it:specificheTecniche:sco:p73
type	DatoNP_Type
facets	Kind Value pattern [1-9]{1}[0-9]*

element **Primo_Modulo_Crediti_Imposta_Type/CreditImpostaRedditiEsteri**

diagram	
namespace	urn:www.agenziaentrate.gov.it:specificheTecniche:sco:p73
type	p73:Crediti_Imposta_Redditi_Esteri_Type
children	p73:StatoEstero p73:Anno p73:RedditoEstero p73:ImpostaEstera p73:RedditoComplessivo p73:Imposta_Lorda p73:ImpostaNetta p73:CreditoDichiarazioniPrecedenti p73:DiCuiStatoEstero

element **Primo_Modulo_Crediti_Imposta_Type/CreditoPrimaCasaSismaAbruzzo**

diagram	
namespace	urn:www.agenziaentrate.gov.it:specificheTecniche:sco:p73
type	extension of p73:Credito_Immobile_Sisma_Abruzzo_Type
children	p73:CodiceFiscale p73:NumeroRata p73:TotaleCredito p73:ResiduoPrecedenteDichiarazione

element **Primo_Modulo_Crediti_Imposta_Type/CreditoPrimaCasaSismaAbruzzo/ResiduoPrecedenteDichiarazione**

diagram					
namespace	urn:www.agenziaentrate.gov.it:specificheTecniche:sco:p73				
type	DatoNP Type				
facets	<table border="1"> <thead> <tr> <th>Kind</th> <th>Value</th> </tr> </thead> <tbody> <tr> <td>pattern</td> <td>[1-9]{1}[0-9]*</td> </tr> </tbody> </table>	Kind	Value	pattern	[1-9]{1}[0-9]*
Kind	Value				
pattern	[1-9]{1}[0-9]*				

element **Primo_Modulo_Crediti_Imposta_Type/CreditoAltriSismaAbruzzo**

diagram	
namespace	urn:www.agenziaentrate.gov.it:specificheTecniche:sco:p73
type	p73:Crediti_Imposta_Altri_Sisma_Abruzzo_Type
children	p73:Impresa_Professione p73:CreditoImmobileSismaAbruzzo p73:Rateazione

element **Primo_Modulo_Crediti_Imposta_Type/CreditoIncrementoOccupazione**

diagram	
namespace	urn:www.agenziaentrate.gov.it:specificheTecniche:sco:p73
children	p73:ResiduoPrecedenteDichiarazione p73:DiCuiCompensatoF24

element **Primo_Modulo_Crediti_Imposta_Type/CreditoIncrementoOccupazione/ResiduoPrecedenteDichiarazione**

diagram	
namespace	urn:www.agenziaentrate.gov.it:specificheTecniche:sco:p73
type	DatoNP_Type
facets	Kind Value pattern [1-9]{1}[0-9]*

element **Primo_Modulo_Crediti_Imposta_Type/CreditoIncrementoOccupazione/DiCuiCompensatoF24**

diagram	
namespace	urn:www.agenziaentrate.gov.it:specificheTecniche:sco:p73
type	DatoNP_Type
facets	Kind Value pattern [1-9]{1}[0-9]*

element **Primo_Modulo_Crediti_Imposta_Type/CreditoImpostaMediazioni**

diagram	
namespace	urn:www.agenziaentrate.gov.it:specificheTecniche:sco:p73
type	p73:Residuo_Credito_Compens_AnnolImposta_Type
children	p73:CreditoAnno p73:DiCuiCompensatoF24

element **Primo_Modulo_Crediti_Imposta_Type/CreditoErogazioniCultura**

diagram	
namespace	urn:www.agenziaentrate.gov.it:specificheTecniche:sco:p73
type	p73:Credito_Erogazioni_Cultura_Type
children	p73:SpesaAnno p73:ResiduoAnnoPrec p73:RataAnnoPrec p73:RataDueAnniPrec

element **Primo_Modulo_Crediti_Imposta_Type/CreditoNegoziazione**

diagram	
namespace	urn:www.agenziaentrate.gov.it:specificheTecniche:sco:p73
type	p73:Credito_Negoziatore_Type
children	p73:CreditoSpettante p73:ResiduoAnnoPrec p73:DiCuiCompensatoF24

element **Primo_Modulo_Crediti_Imposta_Type/CreditoErogazioniScuola**

diagram	
namespace	urn:www.agenziaentrate.gov.it:specificheTecniche:sco:p73
type	p73:Credito_Erogazioni_Scuola_Type
children	p73:SpesaAnno

element **Primo_Modulo_Crediti_Imposta_Type/CreditoVideosorveglianza**

diagram	
namespace	urn:www.agenziaentrate.gov.it:specificheTecniche:sco:p73
type	p73:Credito_Videosorveglianza_Type
children	p73:CreditoSpettante p73:DiCuiCompensatoF24

complexType **Primo_Modulo_Familiari_Type**

diagram	
namespace	urn:www.agenziaentrate.gov.it:specificheTecniche:sco:p73
type	extension of p73:Modulo_Familiari_Type
children	p73:Coniuge p73:PrimoFiglio p73:Familiari p73:PercUlteriore p73:FigliAffidoPread

element **Primo_Modulo_Familiari_Type/PercUlteriore**

diagram					
namespace	urn:www.agenziaentrate.gov.it:specificheTecniche:sco:p73				
type	DatoPC_Type				
facets	<table border="1"> <thead> <tr> <th>Kind</th> <th>Value</th> </tr> </thead> <tbody> <tr> <td>pattern</td> <td>[0-9]?[0-9](,\d{1,3})? 100,(0{1,3})?</td> </tr> </tbody> </table>	Kind	Value	pattern	[0-9]?[0-9](,\d{1,3})? 100,(0{1,3})?
Kind	Value				
pattern	[0-9]?[0-9](,\d{1,3})? 100,(0{1,3})?				

element **Primo_Modulo_Familiari_Type/FigliAffidoPread**

diagram	
---------	--

namespace	urn:www.agenziaentrate.gov.it:specificheTecniche:sco:p73
type	DatoNP_Type
facets	Kind Value pattern [1-9]{1}[0-9]*

complexType **Primo_Modulo_Lavoro_Dip_Type**

diagram	
namespace	urn:www.agenziaentrate.gov.it:specificheTecniche:sco:p73
children	p73:LavoroDipendente p73:PremiRisultato p73:PeriodoLavoro p73:AltriRedditiAssLavDip p73:RitenuteLavoroDipendente p73:BonusIrpef p73:RedditoAlNettoContribPensioni p73:ContribSolidarietaTrattenuto p73:CasellaCasiParticolari

element **Primo_Modulo_Lavoro_Dip_Type/LavoroDipendente**

diagram	
namespace	urn:www.agenziaentrate.gov.it:specificheTecniche:sco:p73
type	p73:Lavoro Dipendente Type
children	p73:TipologiaReddito p73:TipoContratto p73:Reddito

element **Primo Modulo Lavoro Dip Type/PremiRisultato**

<p>diagram</p>	
<p>namespace</p>	<p>urn:www.agenziaentrate.gov.it:specificheTecniche:sco:p73</p>
<p>type</p>	<p>p73:Premi_Risultato_Type</p>
<p>children</p>	<p>p73:TipoLimite p73:ImportoTassazOrdinaria p73:ImportoImpostaSostitutiva p73:RitenuteImpostaSostitutiva p73:Benefit p73:TassazOrdinaria p73:TassazSostitutiva</p>

element **Primo Modulo Lavoro Dip Type/PeriodoLavoro**

<p>diagram</p>	
<p>namespace</p>	<p>urn:www.agenziaentrate.gov.it:specificheTecniche:sco:p73</p>
<p>type</p>	<p>p73:Periodo Di Lavoro_Type</p>
<p>children</p>	<p>p73:GiorniLavoroDipendente p73:GiorniPensione</p>

element **Primo Modulo Lavoro Dip Type/AltriRedditiAssLavDip**

<p>diagram</p>	
<p>namespace</p>	<p>urn:www.agenziaentrate.gov.it:specificheTecniche:sco:p73</p>

type	p73:Altri Redditi Ass Lav Type
children	p73:AssegnoDelConiuge p73:ImportoRedditoAssimilato

element **Primo Modulo Lavoro Dip Type/RitenuteLavoroDipendente**

diagram	
namespace	urn:www.agenziaentrate.gov.it:specificheTecniche:sco:p73
type	p73:Ritenute Lavoro Dip Type
children	p73:Ritlrpef p73:RitAddRegionale p73:RitAccAddComunale p73:RitSaldoAddComunale p73:RitAccAddComAnnoPres

element **Primo Modulo Lavoro Dip Type/Bonuslrpef**

diagram	
namespace	urn:www.agenziaentrate.gov.it:specificheTecniche:sco:p73
type	p73:Bonus_Irpef_Type
children	p73:CodiceBonus p73:BonusErogato p73:Esenzione p73:QuotaTfr

element **Primo Modulo Lavoro Dip Type/RedditoAlNettoContribPensioni**

diagram	
namespace	urn:www.agenziaentrate.gov.it:specificheTecniche:sco:p73

type	DatoNP_Type				
facets	<table border="1"> <tr> <td>Kind</td> <td>Value</td> </tr> <tr> <td>pattern</td> <td>[1-9]{1}[0-9]*</td> </tr> </table>	Kind	Value	pattern	[1-9]{1}[0-9]*
Kind	Value				
pattern	[1-9]{1}[0-9]*				

element **Primo Modulo Lavoro Dip_Type/ContribSolidarietaTrattenuto**

diagram					
namespace	urn:www.agenziaentrate.gov.it:specificheTecniche:sco:p73				
type	DatoNP_Type				
facets	<table border="1"> <tr> <td>Kind</td> <td>Value</td> </tr> <tr> <td>pattern</td> <td>[1-9]{1}[0-9]*</td> </tr> </table>	Kind	Value	pattern	[1-9]{1}[0-9]*
Kind	Value				
pattern	[1-9]{1}[0-9]*				

element **Primo Modulo Lavoro Dip_Type/CasellaCasiParticolari**

diagram													
namespace	urn:www.agenziaentrate.gov.it:specificheTecniche:sco:p73												
type	restriction of DatoN1_Type												
facets	<table border="1"> <tr> <td>Kind</td> <td>Value</td> </tr> <tr> <td>pattern</td> <td>[1-9]</td> </tr> <tr> <td>enumeration</td> <td>1</td> </tr> <tr> <td>enumeration</td> <td>2</td> </tr> <tr> <td>enumeration</td> <td>4</td> </tr> <tr> <td>enumeration</td> <td>5</td> </tr> </table>	Kind	Value	pattern	[1-9]	enumeration	1	enumeration	2	enumeration	4	enumeration	5
Kind	Value												
pattern	[1-9]												
enumeration	1												
enumeration	2												
enumeration	4												
enumeration	5												

complexType **Primo_Modulo_Oneri_Type**

<p>diagram</p>	
<p>namespace</p>	<p>urn:www.agenziaentrate.gov.it:specificheTecniche:sco:p73</p>
<p>children</p>	<p>p73:SpeseDetrazioni p73:SpeseDeduzioni p73:InterventoRecuperoPatrimonioEdilizio p73:DatiCatastaliRecuperoPatrimonioEdilizio p73:InterventoRisparmioEnergetico p73:CanoniLocazione p73:DatiAltreDetrazioni p73:OneriNonAbbattuti p73:SpeseArredo p73:SpeseArredoGiovani p73:IvaAcquistoAbitazione</p>

element **Primo_Modulo_Oneri_Type/SpeseDetrazioni**

<p>diagram</p>	
<p>namespace</p>	<p>urn:www.agenziaentrate.gov.it:specificheTecniche:sco:p73</p>
<p>type</p>	<p>p73:Detrazioni_Type</p>
<p>children</p>	<p>p73:CasellaRateazione p73:SpeseDeterminatePatologie p73:SpeseSanitarie p73:SpeseFamNonACarico p73:SpeseSanitarieDisabili p73:VeicoliDisabili p73:AcquistoCaniGuida p73:SpeseRateizzate p73:MutuiAbPrincipale p73:AltreSpese p73:SpeseLeasing</p>

element **Primo_Modulo_Oneri_Type/SpeseDeduzioni**

<p>diagram</p>	
<p>namespace</p>	<p>urn:www.agenziaentrate.gov.it:specificheTecniche:sco:p73</p>
<p>type</p>	<p>p73:Deduzioni_Type</p>
<p>children</p>	<p>p73:ContributiPrevAss p73:AssegnoConiuge p73:ContributiColf p73:ErogazioniIstituzioniReligiose p73:SpesePortatoriHandicap p73:AltriOneri p73:DeducibilitaOrdinaria p73:LavoratoriPrimaOccupazione p73:FondiInSquilibrioFinanziario p73:FamiliariACarico p73:FondoPensioneDipendentiPubblici p73:AcquistoCostruzioneAbitLocazione p73:RestituzioneSomme</p>

element **Primo_Modulo_Oneri_Type/InterventoRecuperoPatrimonioEdilizio**

<p>diagram</p>	
<p>namespace</p>	<p>urn:www.agenziaentrate.gov.it:specificheTecniche:sco:p73</p>
<p>type</p>	<p>p73:Intervento Ricupero Patrimonio Edilizio Type</p>
<p>children</p>	<p>p73:Anno p73:Periodo p73:CodiceFiscale p73:CasellaInterventiParticolari p73:CodiceSituazioniParticolari p73:Rate10 p73:Spesa p73:NOrdineImmobile</p>

element **Primo_Modulo_Oneri_Type/DatiCatastaliRecuperoPatrimonioEdilizio**

<p>diagram</p>	
<p>namespace</p>	<p>urn:www.agenziaentrate.gov.it:specificheTecniche:sco:p73</p>
<p>type</p>	<p>p73:Sezione Dati Catastali Ricupero Patrimonio Edilizio Type</p>
<p>children</p>	<p>p73:DatiCatastaliRecuperoPatrimonioEdilizio p73:DatiRegistrazioneAccatamentoRecuperoPatrimonio Edilizio</p>

element **Primo_Modulo_Oneri_Type/InterventoRisparmioEnergetico**

<p>diagram</p>	
<p>namespace</p>	<p>urn:www.agenziaentrate.gov.it:specificheTecniche:sco:p73</p>
<p>type</p>	<p>p73:Intervento Risparmio Energetico Type</p>
<p>children</p>	<p>p73:TipoIntervento p73:Anno p73:Periodo2013 p73:CasiParticolari p73:RideterminazioneRate p73:RipartizioneRate p73:NumeroRata p73:Spesa</p>

element **Primo_Modulo_Oneri_Type/CanoniLocazione**

<p>diagram</p>	
<p>namespace</p>	<p>urn:www.agenziaentrate.gov.it:specificheTecniche:sco:p73</p>
<p>type</p>	<p>p73:Detrazioni Canoni Locazione Type</p>
<p>children</p>	<p>p73:InquiliniAbitazionePrincipale p73:DipendentiTrasferiti</p>

element **Primo_Modulo_Oneri_Type/DatiAltreDetrazioni**

<p>diagram</p>	
<p>namespace</p>	<p>urn:www.agenziaentrate.gov.it:specificheTecniche:sco:p73</p>
<p>type</p>	<p>p73:Dati_Altre_Detrazioni_Type</p>
<p>children</p>	<p>p73:SpeseCaniGuida p73:AffittoTerreniAgricoliGiovani p73:AltreDetrazioni</p>

element **Primo_Modulo_Oneri_Type/OneriNonAbbattuti**

<p>diagram</p>	
<p>namespace</p>	<p>urn:www.agenziaentrate.gov.it:specificheTecniche:sco:p73</p>
<p>type</p>	<p>p73:Oneri Non Abbattuti Type</p>
<p>children</p>	<p>p73:DetrazSpeseAssPersonale p73:DetrazErogazBiennaleVenezia p73:DetrazErogazSpettacolo p73:DetrazErogazSettoreMusicale p73:DeduzContributiPaesiSviluppo p73:DeduzOnlus p73:DetrazOspedaleGalliera p73:PrevidenzaComplDipPubblici p73:InteressiMutuiAgrari p73:DeduzTrust</p>

element **Primo_Modulo_Oneri_Type/SpeseArredo**

diagram	<p>The diagram shows a class <code>p73:SpeseArredo</code> with a multiplicity of <code>0..2</code> connected to a class <code>p73:Spese_Arredo_Type</code>. The <code>p73:Spese_Arredo_Type</code> class contains two attributes: <code>p73:NumeroRata</code> and <code>p73:Importo</code>.</p>
namespace	urn:www.agenziaentrate.gov.it:specificheTecniche:sco:p73
type	p73:Spese_Arredo_Type
children	p73:NumeroRata p73:Importo

element **Primo_Modulo_Oneri_Type/SpeseArredoGiovani**

diagram	<p>The diagram shows a class <code>p73:SpeseArredoGiovani</code> connected to a class <code>p73:Spese_Arredo_Giovani_Coppie_Type</code>. The <code>p73:Spese_Arredo_Giovani_Coppie_Type</code> class contains three attributes: <code>p73:Meno35Anni</code>, <code>p73:NumeroRata</code>, and <code>p73:Importo</code>.</p>
namespace	urn:www.agenziaentrate.gov.it:specificheTecniche:sco:p73
type	p73:Spese_Arredo_Giovani_Coppie_Type
children	p73:Meno35Anni p73:NumeroRata p73:Importo

element **Primo_Modulo_Oneri_Type/IvaAcquistoAbitazione**

diagram	<p>The diagram shows a class <code>p73:IvaAcquistoAbitazione</code> connected to a class <code>p73:Iva_Acquisto_Abitazione_Type</code>. The <code>p73:Iva_Acquisto_Abitazione_Type</code> class contains two attributes: <code>p73:NumeroRata</code> and <code>p73:Importo</code>.</p>
namespace	urn:www.agenziaentrate.gov.it:specificheTecniche:sco:p73
type	p73:Iva_Acquisto_Abitazione_Type
children	p73:NumeroRata p73:Importo

complexType **Primo_Modulo_PL_Type**

diagram	
namespace	urn:www.agenziaentrate.gov.it:specificheTecniche:sco:p73
children	p73:Prospetto p73:ProspettoRideterminato

element **Primo_Modulo_PL_Type/Prospetto**

diagram	
namespace	urn:www.agenziaentrate.gov.it:specificheTecniche:sco:p73
type	extension of p73:Prospetto_Type
children	p73:RiepilogoRedditi p73:ImpostaLorda p73:DetrazioniCrediti p73:ImpostaNetta p73:Addizionali p73:CedolareSecca p73:ContributoSolidarieta p73:LiquidazioneImposte p73:AltriDati p73:CredImpEestero p73:DatiCreditiF24

element **Primo_Modulo_PL_Type/Prospetto/Addizionali**

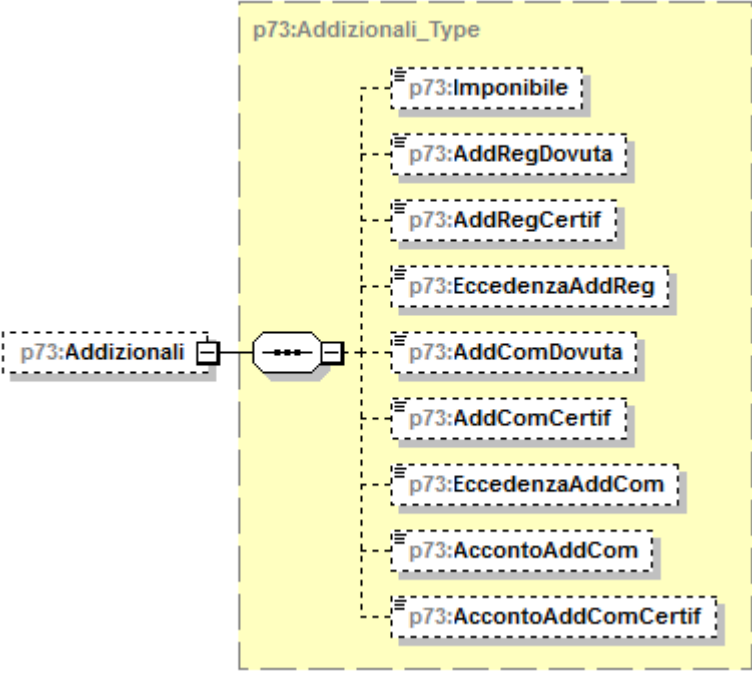
<p>diagram</p>	
<p>namespace</p>	<p>urn:www.agenziaentrate.gov.it:specificheTecniche:sco:p73</p>
<p>type</p>	<p>p73:Addizionali_Type</p>
<p>children</p>	<p>p73:Imponibile p73:AddRegDovuta p73:AddRegCertif p73:EcceденzaAddReg p73:AddComDovuta p73:AddComCertif p73:EcceденzaAddCom p73:AccontoAddCom p73:AccontoAddComCertif</p>

element **Primo_Modulo_PL_Type/Prospetto/CedolareSecca**

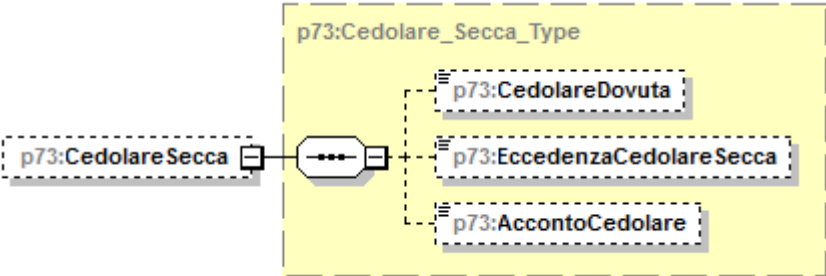
<p>diagram</p>	
<p>namespace</p>	<p>urn:www.agenziaentrate.gov.it:specificheTecniche:sco:p73</p>
<p>type</p>	<p>p73:Cedolare_Secca_Type</p>
<p>children</p>	<p>p73:CedolareDovuta p73:EcceденzaCedolareSecca p73:AccontoCedolare</p>

element **Primo_Modulo_PL_Type/Prospetto/ContributoSolidarieta**

diagram	
namespace	urn:www.agenziaentrate.gov.it:specificheTecniche:sco:p73
type	p73:Contributo_Solidarieta_Type
children	p73:ImponibileContributo p73:ContributoDovuto p73:ContributoCertificaz

element **Primo_Modulo_PL_Type/Prospetto/LiquidazioneImposte**

diagram	
namespace	urn:www.agenziaentrate.gov.it:specificheTecniche:sco:p73
children	p73:EsitoIrpref p73:EsitoAddRegionale p73:EsitoAddComunale p73:PrimaRataAcclrpref p73:SecondaRataAcclrpref p73:AccontoTassSep p73:AccontoAddComunale p73:ImpostaSostitutiva p73:EsitoCedolareSecca p73:PrimaRataAccCedolare p73:SecondaRataAccCedolare p73:ContribSolidarietaDebito

element **Primo_Modulo_PL_Type/Prospetto/LiquidazioneImposte/EsitoIrpef**

diagram	
namespace	urn:www.agenziaentrate.gov.it:specificheTecniche:sco:p73
type	p73:Esito_Liquidazione_Type
children	p73:Credito p73:Debito

element **Primo_Modulo_PL_Type/Prospetto/LiquidazioneImposte/EsitoAddRegionale**

diagram	
namespace	urn:www.agenziaentrate.gov.it:specificheTecniche:sco:p73
type	extension of p73:Esito_Liquidazione_Type
children	p73:Credito p73:Debito p73:CodAddReg

element **Primo_Modulo_PL_Type/Prospetto/LiquidazioneImposte/EsitoAddRegionale/CodAddReg**

diagram																																			
namespace	urn:www.agenziaentrate.gov.it:specificheTecniche:sco:p73																																		
type	Codice Regione Type																																		
facets	<table border="1"> <thead> <tr> <th>Kind</th> <th>Value</th> </tr> </thead> <tbody> <tr> <td>pattern</td> <td>(([0-9A-Z\-\-] \&quot;){1}([0-9A-Z&amp;] ' \- \., /° ^\(\\)À È É Ì Ò Ù Û \&quot; \\ \\+)*</td> </tr> <tr> <td>enumeration</td> <td>1</td> </tr> <tr> <td>enumeration</td> <td>2</td> </tr> <tr> <td>enumeration</td> <td>3</td> </tr> <tr> <td>enumeration</td> <td>4</td> </tr> <tr> <td>enumeration</td> <td>5</td> </tr> <tr> <td>enumeration</td> <td>6</td> </tr> <tr> <td>enumeration</td> <td>7</td> </tr> <tr> <td>enumeration</td> <td>8</td> </tr> <tr> <td>enumeration</td> <td>9</td> </tr> <tr> <td>enumeration</td> <td>10</td> </tr> <tr> <td>enumeration</td> <td>11</td> </tr> <tr> <td>enumeration</td> <td>12</td> </tr> <tr> <td>enumeration</td> <td>13</td> </tr> <tr> <td>enumeration</td> <td>14</td> </tr> <tr> <td>enumeration</td> <td>15</td> </tr> </tbody> </table>	Kind	Value	pattern	(([0-9A-Z\-\-] \"){1}([0-9A-Z&] ' \- \., /° ^\(\\)À È É Ì Ò Ù Û \" \\ \\+)*	enumeration	1	enumeration	2	enumeration	3	enumeration	4	enumeration	5	enumeration	6	enumeration	7	enumeration	8	enumeration	9	enumeration	10	enumeration	11	enumeration	12	enumeration	13	enumeration	14	enumeration	15
Kind	Value																																		
pattern	(([0-9A-Z\-\-] \"){1}([0-9A-Z&] ' \- \., /° ^\(\\)À È É Ì Ò Ù Û \" \\ \\+)*																																		
enumeration	1																																		
enumeration	2																																		
enumeration	3																																		
enumeration	4																																		
enumeration	5																																		
enumeration	6																																		
enumeration	7																																		
enumeration	8																																		
enumeration	9																																		
enumeration	10																																		
enumeration	11																																		
enumeration	12																																		
enumeration	13																																		
enumeration	14																																		
enumeration	15																																		

enumeration	16
enumeration	17
enumeration	18
enumeration	19
enumeration	20
enumeration	21

element Primo_Modulo_PL_Type/Prospetto/LiquidazioneImposte/EsitoAddComunale

diagram	
namespace	urn:www.agenziaentrate.gov.it:specificheTecniche:sco:p73
type	extension of p73:Esito_Liquidazione_Type
children	p73:Credito p73:Debito p73:CodiceAddCom

element Primo_Modulo_PL_Type/Prospetto/LiquidazioneImposte/EsitoAddComunale/CodiceAddCom

diagram					
namespace	urn:www.agenziaentrate.gov.it:specificheTecniche:sco:p73				
type	DatoAN_Type				
facets	<table border="1"> <tr> <th>Kind</th> <th>Value</th> </tr> <tr> <td>pattern</td> <td>([0-9A-Z\-\]&quot;){1}([0-9A-Z&amp; ; ' - \., / ° '^\(\ \) À É È Ì Ò Ù Ú &quot; ; \\ / +)*</td> </tr> </table>	Kind	Value	pattern	([0-9A-Z\-\]"){1}([0-9A-Z& ; ' - \., / ° '^\(\ \) À É È Ì Ò Ù Ú " ; \\ / +)*
Kind	Value				
pattern	([0-9A-Z\-\]"){1}([0-9A-Z& ; ' - \., / ° '^\(\ \) À É È Ì Ò Ù Ú " ; \\ / +)*				

element Primo_Modulo_PL_Type/Prospetto/LiquidazioneImposte/PrimaRataAcclrpef

diagram					
namespace	urn:www.agenziaentrate.gov.it:specificheTecniche:sco:p73				
type	DatoNP_Type				
facets	<table border="1"> <tr> <th>Kind</th> <th>Value</th> </tr> <tr> <td>pattern</td> <td>[1-9]{1}[0-9]*</td> </tr> </table>	Kind	Value	pattern	[1-9]{1}[0-9]*
Kind	Value				
pattern	[1-9]{1}[0-9]*				

element Primo_Modulo_PL_Type/Prospetto/LiquidazioneImposte/SecondaRataAcclrpef

diagram	
namespace	urn:www.agenziaentrate.gov.it:specificheTecniche:sco:p73
type	DatoNP_Type

facets	Kind pattern	Value [1-9]{1}[0-9]*
--------	-----------------	-------------------------

element **Primo_Modulo_PL_Type/Prospetto/LiquidazioneImposte/AccontoTassSep**

diagram	
namespace	urn:www.agenziaentrate.gov.it:specificheTecniche:sco:p73
type	p73:Debito_Type
children	p73:NonVersare p73:ImportoDaTrattenere

element **Primo_Modulo_PL_Type/Prospetto/LiquidazioneImposte/AccontoAddComunale**

diagram	
namespace	urn:www.agenziaentrate.gov.it:specificheTecniche:sco:p73
children	p73:CodiceAddComAcconto p73:AccontoAddCom

element **Primo_Modulo_PL_Type/Prospetto/LiquidazioneImposte/AccontoAddComunale/CodiceAddComAcconto**

diagram		
namespace	urn:www.agenziaentrate.gov.it:specificheTecniche:sco:p73	
type	DatoAN_Type	
facets	Kind pattern	Value ([0-9A-Z\-_]\"){1}([0-9A-Z&#39; ! - \., / ° °\°\(\) À É È Ì Ò Ù Û " \ \\ /+)*

element **Primo_Modulo_PL_Type/Prospetto/LiquidazioneImposte/AccontoAddComunale/AccontoAddCom**

diagram		
namespace	urn:www.agenziaentrate.gov.it:specificheTecniche:sco:p73	
type	DatoNP_Type	
facets	Kind pattern	Value [1-9]{1}[0-9]*

element Primo_Modulo_PL_Type/Prospetto/LiquidazioneImposte/ImpostaSostitutiva

diagram	<p>The diagram shows a dashed box labeled 'p73:ImpostaSostitutiva' connected to a solid box labeled 'p73:Debito_Type'. Inside the 'p73:Debito_Type' box, there are two other dashed boxes: 'p73:NonVersare' and 'p73:ImportoDaTrattenere'.</p>
namespace	urn:www.agenziaentrate.gov.it:specificheTecniche:sco:p73
type	p73:Debito_Type
children	p73:NonVersare p73:ImportoDaTrattenere

element Primo_Modulo_PL_Type/Prospetto/LiquidazioneImposte/EsitoCedolareSecca

diagram	<p>The diagram shows a dashed box labeled 'p73:EsitoCedolareSecca' connected to a solid box labeled 'p73:Esito_Liquidazione_Type'. Inside the 'p73:Esito_Liquidazione_Type' box, there are two other dashed boxes: 'p73:Credito' and 'p73:Debito'.</p>
namespace	urn:www.agenziaentrate.gov.it:specificheTecniche:sco:p73
type	p73:Esito_Liquidazione_Type
children	p73:Credito p73:Debito

element Primo_Modulo_PL_Type/Prospetto/LiquidazioneImposte/PrimaRataAccCedolare

diagram	<p>The diagram shows a dashed box labeled 'p73:PrimaRataAccCedolare'.</p>				
namespace	urn:www.agenziaentrate.gov.it:specificheTecniche:sco:p73				
type	DatoNP_Type				
facets	<table border="1"> <thead> <tr> <th>Kind</th> <th>Value</th> </tr> </thead> <tbody> <tr> <td>pattern</td> <td>[1-9]{1}[0-9]*</td> </tr> </tbody> </table>	Kind	Value	pattern	[1-9]{1}[0-9]*
Kind	Value				
pattern	[1-9]{1}[0-9]*				

element Primo_Modulo_PL_Type/Prospetto/LiquidazioneImposte/SecondaRataAccCedolare

diagram	<p>The diagram shows a dashed box labeled 'p73:SecondaRataAccCedolare'.</p>				
namespace	urn:www.agenziaentrate.gov.it:specificheTecniche:sco:p73				
type	DatoNP_Type				
facets	<table border="1"> <thead> <tr> <th>Kind</th> <th>Value</th> </tr> </thead> <tbody> <tr> <td>pattern</td> <td>[1-9]{1}[0-9]*</td> </tr> </tbody> </table>	Kind	Value	pattern	[1-9]{1}[0-9]*
Kind	Value				
pattern	[1-9]{1}[0-9]*				

element **Primo_Modulo_PL_Type/Prospetto/LiquidazioneImposte/ContribSolidarietaDebito**

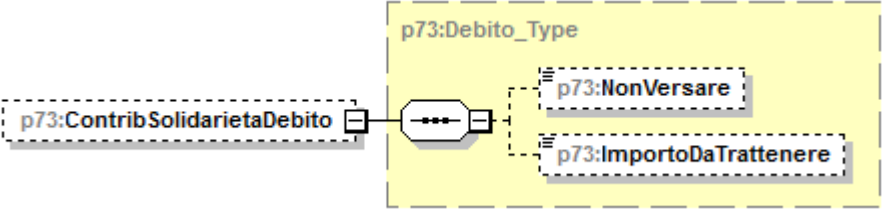
<p>diagram</p>	 <p>The diagram shows a class <code>p73:ContribSolidarietaDebito</code> (represented by a dashed box) connected to a class <code>p73:Debito_Type</code> (represented by a solid box). Inside <code>p73:Debito_Type</code>, there are two subclasses: <code>p73:NonVersare</code> and <code>p73:ImportoDaTrattenere</code>, both shown in dashed boxes. The connection between <code>p73:ContribSolidarietaDebito</code> and <code>p73:Debito_Type</code> is a solid line with a small square at the end pointing to <code>p73:Debito_Type</code>.</p>
<p>namespace</p>	<p>urn:www.agenziaentrate.gov.it:specificheTecniche:sco:p73</p>
<p>type</p>	<p>p73:Debito_Type</p>
<p>children</p>	<p>p73:NonVersare p73:ImportoDaTrattenere</p>

element **Primo_Modulo_PL_Type/Prospetto/AltriDati**

<p>diagram</p>	
<p>namespace</p>	<p>urn:www.agenziaentrate.gov.it:specificheTecniche:sco:p73</p>
<p>type</p>	<p>p73:Altri Dati Type</p>
<p>children</p>	<p>p73:ResiduoCreditoErogazioneCultura p73:ResiduoCreditoPrimaCasa p73:ResiduoCreditoOccupazione p73:ResiduoCreditoSisma p73:ResiduoCreditoFondiPensione p73:ResiduoCreditoMediazioni p73:TotSpeseSanitarieRateizzate p73:RedditoAgevolazioniFiscali p73:RedditoComplessivoAcconto p73:RigoDifferenzaAcconto p73:AccontiCompensatiIntern p73:RedditiFondariNonImponibili p73:RedditoAbitazionePrincipalePertinenze p73:ResiduoDeduzioneSommeRestituite p73:ResiduoErogazioniScuola p73:ResiduoCreditoNegoziazione p73:ResiduoCreditoVideosorveglianza p73:CreditoErogazioneCultura</p>

element **Primo_Modulo_PL_Type/Prospetto/CredImpEstero**

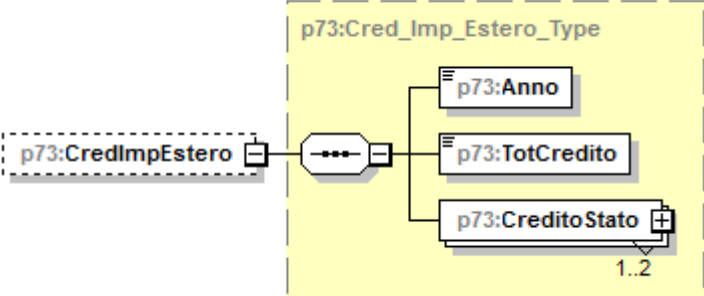
<p>diagram</p>	 <p>The diagram illustrates the structure of the <code>p73:CredImpEstero</code> element. It is represented as a dashed box on the left, connected to a larger container box labeled <code>p73:Cred_Imp_Estero_Type</code>. Inside this container, there are three sub-elements: <code>p73:Anno</code>, <code>p73:TotCredito</code>, and <code>p73:CreditoStato</code>. The <code>p73:CreditoStato</code> element has a multiplicity of <code>1..2</code> indicated by a small box with a plus sign and the text <code>1..2</code> below it.</p>
<p>namespace</p>	<p>urn:www.agenziaentrate.gov.it:specificheTecniche:sco:p73</p>
<p>type</p>	<p>p73:Cred_Imp_Estero_Type</p>
<p>children</p>	<p>p73:Anno p73:TotCredito p73:CreditoStato</p>

element **Primo_Modulo_PL_Type/Prospetto/DatiCreditiF24**

<p>diagram</p>	
<p>namespace</p>	<p>urn:www.agenziaentrate.gov.it:specificheTecniche:sco:p73</p>
<p>type</p>	<p>p73:Crediti_F24_Type</p>
<p>children</p>	<p>p73:Credlrpef p73:CredlrpefDipNoSostituto p73:CodAddReg p73:CredAddReg p73:CredAddRegDipNoSostituto p73:CodiceAddCom p73:CredAddCom p73:CredAddComDipNoSostituto p73:CredCedolare p73:CredCedolareDipNoSostituto p73:CredTassSeparDipNoSostituto p73:CredImpostaSostDipNoSostituto p73:CredSolidarietaDipNoSostituto p73:Totale p73:TotaleDipNoSostituto</p>

element **Primo_Modulo_PL_Type/ProspettoRideterminato**

diagram	
namespace	urn:www.agenziaentrate.gov.it:specificheTecniche:sco:p73
type	extension of p73:Prospetto_Type
children	p73:RiepilogoRedditi p73:ImpostaLorda p73:DetrazioniCrediti p73:ImpostaNetta p73:RedditoAgevolazioniFiscali

element **Primo_Modulo_PL_Type/ProspettoRideterminato/RedditoAgevolazioniFiscali**

diagram					
namespace	urn:www.agenziaentrate.gov.it:specificheTecniche:sco:p73				
type	DatoNP_Type				
facets	<table border="1"> <thead> <tr> <th>Kind</th> <th>Value</th> </tr> </thead> <tbody> <tr> <td>pattern</td> <td>[1-9]{1}[0-9]*</td> </tr> </tbody> </table>	Kind	Value	pattern	[1-9]{1}[0-9]*
Kind	Value				
pattern	[1-9]{1}[0-9]*				

complexType **Prospetto_Liquidazione_Type**

diagram	
namespace	urn:www.agenziaentrate.gov.it:specificheTecniche:sco:p73
children	p73:PrimoModulo p73:Modulo

element **Prospetto_Liquidazione_Type/PrimoModulo**

diagram	
---------	--

namespace	urn:www.agenziaentrate.gov.it:specificheTecniche:sco:p73
type	p73:Primo_Modulo_PL_Type
children	p73:Prospetto p73:ProspettoRideterminato

element Prospetto_Liquidazione_Type/Modulo

diagram	
namespace	urn:www.agenziaentrate.gov.it:specificheTecniche:sco:p73
type	p73:Modulo_PL_Type
children	p73:CredImpEstero

complexType Prospetto_Type

diagram	
namespace	urn:www.agenziaentrate.gov.it:specificheTecniche:sco:p73
children	p73:RiepilogoRedditi p73:ImpostaLorda p73:DetrazioniCrediti p73:ImpostaNetta

element **Prospetto_Type/RiepilogoRedditi**

<p>diagram</p>	
<p>namespace</p>	<p>urn:www.agenziaentrate.gov.it:specificheTecniche:sco:p73</p>
<p>type</p>	<p>p73:Riepilogo_Redditi_Type</p>
<p>children</p>	<p>p73:Dominicali p73:Agrari p73:Fabbricati p73:LavDip p73:AltriRedditi p73:ImponibileCedolare p73:ImponibileCedolareOrdinario p73:ImponibileCedolareAgevolato p73:AbitazionePrincipalePertinenze</p>

element **Prospetto_Type/ImpostaLorda**

<p>diagram</p>	
<p>namespace</p>	<p>urn:www.agenziaentrate.gov.it:specificheTecniche:sco:p73</p>
<p>type</p>	<p>p73:Imposta_Lorda_Type</p>
<p>children</p>	<p>p73:RedditoComplessivo p73:DeduzioneAbitazPrincipale p73:OneriDeducibili p73:RedditoImponibile p73:CompensiAttSport p73:ImportoImpostaLorda</p>

element **Prospetto_Type/DetrazioniCrediti**

<p>diagram</p>	<p>The diagram illustrates the structure of the p73:DetrazioniCrediti element. It is composed of a p73:Detrazione_Crediti_Type container, which is highlighted in yellow. This container includes the following sub-elements:</p> <ul style="list-style-type: none"> p73:DetrazioneConiuge p73:DetrazioneFigli p73:UlterioreDetrazioneFigli p73:DetrazioneFamiliari p73:DetrazioneLavDip p73:DetrazionePens p73:DetrazioneAltriRedditi p73:DetrazioneOneri p73:DetrazioneRistrutturazione p73:DetrazioniArredolmobili p73:DetrazioneRisparmioEnergie... p73:DetrazioneArredoGiovaniCo... p73:DetrazioneIvaAcquistoAbitaz p73:DetrazioneLocEAgricoliGiov... p73:AltreDetrazioni p73:CreditoPrimaCasa p73:CreditoOccupazione p73:CreditoFondiPensione p73:CreditoMediazioni p73:CreditoNegoziazione p73:TotaleDetrazioniCrediti <p>The p73:DetrazioniCrediti element is shown as a dashed box on the left, connected to the p73:Detrazione_Crediti_Type container by a solid line with a small square at the end, indicating a composition relationship.</p>
<p>namespace</p>	<p>urn:www.agenziaentrate.gov.it:specificheTecniche:sco:p73</p>
<p>type</p>	<p>p73:Detrazione_Crediti_Type</p>

children	<p>p73:DetrazioneConiuge p73:DetrazioneFigli p73:UlterioreDetrazioneFigli p73:DetrazioneFamiliari p73:DetrazioneLavDip p73:DetrazionePens p73:DetrazioneAltriRedditi p73:DetrazioneOneri p73:DetrazioneRistrutturazione p73:DetrazioniArredolmmobili p73:DetrazioneRisparmioEnergetico p73:DetrazioneArredoGiovaniCoppie p73:DetrazioneIvaAcquistoAbitaz p73:DetrazioneLocEAgricoliGiovani p73:AltreDetrazioni p73:CreditoPrimaCasa p73:CreditoOccupazione p73:CreditoFondiPensione p73:CreditoMediazioni p73:CreditoNegoziazione p73:TotaleDetrazioniCrediti</p>
----------	--

element **Prospetto_Type/ImpostaNetta**

diagram	
namespace	urn:www.agenziaentrate.gov.it:specificheTecniche:sco:p73
type	p73:Imposta_Netta_Type

children	p73:ImportoImpostaNetta p73:CredAltriSisma p73:CredAbitazSisma p73:CredImpEstere p73:CredErogCultura p73:CredErogScuola p73:CredVideosorveglianza p73:CredCanNonPerc p73:CredDetrazIncipienti p73:Ritenute p73:Differenza p73:Eccedenzalrpef p73:AccontiVersati p73:RestituzioneBonus p73:CredRimborsatiSost p73:BonuslrpefSpettante p73:BonuslrpefRiconosciuto p73:RestituzioneBonuslrpef
----------	--

complexType **Redditi_Capitale_Type**

diagram	
namespace	urn:www.agenziaentrate.gov.it:specificheTecniche:sco:p73
children	p73:Utili p73:AltriRedditiDiCapitale p73:LavoroAutonomo p73:RedditiDiversi p73:RedditiDiversiDetraz

element **Redditi_Capitale_Type/Utili**

diagram	
namespace	urn:www.agenziaentrate.gov.it:specificheTecniche:sco:p73
type	p73:Altri_Redditi_Utili_Type
children	p73:Tipo_Reddito p73:RedditiRitenute

element **Redditi_Capitale_Type/AltriRedditiDiCapitale**

diagram	
namespace	urn:www.agenziaentrate.gov.it:specificheTecniche:sco:p73
type	p73:Sezione_Altri_Redd_Type
children	p73:TipoReddito p73:RedditiRitenute

element **Redditi_Capitale_Type/LavoroAutonomo**

diagram	
namespace	urn:www.agenziaentrate.gov.it:specificheTecniche:sco:p73
type	p73:Altri_Redditi_Lavoro_Autonomo_Type
children	p73:TipoReddito p73:RedditiRitenute

element **Redditi_Capitale_Type/RedditiDiversi**

diagram	
namespace	urn:www.agenziaentrate.gov.it:specificheTecniche:sco:p73
type	p73:Altri_Redditi_Diversi_Type
children	p73:TipoReddito p73:RedditiRitenuteSpese

element **Redditi_Capitale_Type/RedditiDiversiDetraz**

diagram	
namespace	urn:www.agenziaentrate.gov.it:specificheTecniche:sco:p73
type	p73:Altri_Redditi_Diversi_Detr_Type
children	p73:Tipo_Reddito p73:RedditiRitenuteSpese

complexType **Redditi_Eredi_Legatari_Type**

diagram	
namespace	urn:www.agenziaentrate.gov.it:specificheTecniche:sco:p73
type	extension of p73:Tassazione_Separata_Type
children	p73:Opzione p73:Anno p73:RedditoRitenute p73:TipoReddito p73:RedditoTotale p73:QuotalmposteSuccessioni

element **Redditi_Eredi_Legatari_Type/TipoReddito**

diagram																													
namespace	urn:www.agenziaentrate.gov.it:specificheTecniche:sco:p73																												
type	p73:Tipo_Reddito_Da1a12_Type																												
facets	<table border="1"> <thead> <tr> <th>Kind</th> <th>Value</th> </tr> </thead> <tbody> <tr> <td>pattern</td> <td>[1-9]{1}[0-9]*</td> </tr> <tr> <td>enumeration</td> <td>1</td> </tr> <tr> <td>enumeration</td> <td>2</td> </tr> <tr> <td>enumeration</td> <td>3</td> </tr> <tr> <td>enumeration</td> <td>4</td> </tr> <tr> <td>enumeration</td> <td>5</td> </tr> <tr> <td>enumeration</td> <td>6</td> </tr> <tr> <td>enumeration</td> <td>7</td> </tr> <tr> <td>enumeration</td> <td>8</td> </tr> <tr> <td>enumeration</td> <td>9</td> </tr> <tr> <td>enumeration</td> <td>10</td> </tr> <tr> <td>enumeration</td> <td>11</td> </tr> <tr> <td>enumeration</td> <td>12</td> </tr> </tbody> </table>	Kind	Value	pattern	[1-9]{1}[0-9]*	enumeration	1	enumeration	2	enumeration	3	enumeration	4	enumeration	5	enumeration	6	enumeration	7	enumeration	8	enumeration	9	enumeration	10	enumeration	11	enumeration	12
Kind	Value																												
pattern	[1-9]{1}[0-9]*																												
enumeration	1																												
enumeration	2																												
enumeration	3																												
enumeration	4																												
enumeration	5																												
enumeration	6																												
enumeration	7																												
enumeration	8																												
enumeration	9																												
enumeration	10																												
enumeration	11																												
enumeration	12																												

element **Redditi_Eredi_Legatari_Type/RedditoTotale**

diagram					
namespace	urn:www.agenziaentrate.gov.it:specificheTecniche:sco:p73				
type	DatoNP_Type				
facets	<table border="1"> <thead> <tr> <th>Kind</th> <th>Value</th> </tr> </thead> <tbody> <tr> <td>pattern</td> <td>[1-9]{1}[0-9]*</td> </tr> </tbody> </table>	Kind	Value	pattern	[1-9]{1}[0-9]*
Kind	Value				
pattern	[1-9]{1}[0-9]*				

element **Redditi_Eredi_Legatari_Type/QuotalImposteSuccessioni**

diagram	
namespace	urn:www.agenziaentrate.gov.it:specificheTecniche:sco:p73
type	DatoNP_Type
facets	Kind Value pattern [1-9]{1}[0-9]*

complexType **Redditi_Fabbricati_Type**

diagram	
namespace	urn:www.agenziaentrate.gov.it:specificheTecniche:sco:p73
children	p73:Modulo

element **Redditi_Fabbricati_Type/Modulo**

diagram	
namespace	urn:www.agenziaentrate.gov.it:specificheTecniche:sco:p73
type	p73:Modulo_Fabbricato_Type
children	p73:FabbricatoOrd p73:FabbricatoAgev

complexType **Redditi_Lavoro_Dip_Type**

diagram	
namespace	urn:www.agenziaentrate.gov.it:specificheTecniche:sco:p73
children	p73:PrimoModulo p73:Modulo

element **Redditi_Lavoro_Dip_Type/PrimoModulo**

<p>diagram</p>	
<p>namespace</p>	<p>urn:www.agenziaentrate.gov.it:specificheTecniche:sco:p73</p>
<p>type</p>	<p>p73:Primo_Modulo_Lavoro_Dip_Type</p>
<p>children</p>	<p>p73:LavoroDipendente p73:PremiRisultato p73:PeriodoLavoro p73:AltriRedditiAssLavDip p73:RitenuteLavoroDipendente p73:Bonuslrpef p73:RedditoAlNettoContribPensioni p73:ContribSolidarietaTrattenuto p73:CasellaCasiParticolari</p>

element **Redditi_Lavoro_Dip_Type/Modulo**

<p>diagram</p>	
<p>namespace</p>	<p>urn:www.agenziaentrate.gov.it:specificheTecniche:sco:p73</p>
<p>type</p>	<p>p73:Modulo_Lavoro_Dip_Type</p>

children	p73:LavoroDipendente p73:PremiRisultato p73:AltriRedditiAssLavDip p73:Bonuslrpef
----------	--

complexType Redditi_Ritenute_Spese_Type

diagram	
namespace	urn:www.agenziaentrate.gov.it:specificheTecniche:sco:p73
type	extension of p73:Redditi_Ritenute_Type
children	p73:ImportoRedditi p73:ImportoRitenute p73:ImportoSpese

element Redditi_Ritenute_Spese_Type/ImportoSpese

diagram					
namespace	urn:www.agenziaentrate.gov.it:specificheTecniche:sco:p73				
type	DatoNP_Type				
facets	<table border="1"> <tr> <th>Kind</th> <th>Value</th> </tr> <tr> <td>pattern</td> <td>[1-9]{1}[0-9]*</td> </tr> </table>	Kind	Value	pattern	[1-9]{1}[0-9]*
Kind	Value				
pattern	[1-9]{1}[0-9]*				

complexType Redditi_Ritenute_Type

diagram	
namespace	urn:www.agenziaentrate.gov.it:specificheTecniche:sco:p73
children	p73:ImportoRedditi p73:ImportoRitenute

element Redditi_Ritenute_Type/ImportoRedditi

diagram					
namespace	urn:www.agenziaentrate.gov.it:specificheTecniche:sco:p73				
type	DatoNP_Type				
facets	<table border="1"> <tr> <th>Kind</th> <th>Value</th> </tr> <tr> <td>pattern</td> <td>[1-9]{1}[0-9]*</td> </tr> </table>	Kind	Value	pattern	[1-9]{1}[0-9]*
Kind	Value				
pattern	[1-9]{1}[0-9]*				

element Redditi_Ritenute_Type/ImportoRitenute

diagram	
namespace	urn:www.agenziaentrate.gov.it:specificheTecniche:sco:p73
type	DatoNP_Type
facets	Kind Value pattern [1-9]{1}[0-9]*

complexType Redditi_Tassazione_Separata_Type

diagram	
namespace	urn:www.agenziaentrate.gov.it:specificheTecniche:sco:p73
children	p73:RedditiErede p73:ImposteRimborsate

element Redditi_Tassazione_Separata_Type/RedditiErede

diagram	
namespace	urn:www.agenziaentrate.gov.it:specificheTecniche:sco:p73
type	p73:Redditi_Eredi_Legatari_Type
children	p73:Opzione p73:Anno p73:RedditoRitenute p73:TipoReddito p73:RedditoTotale p73:QuotalImposteSuccessioni

element **Redditi_Tassazione_Separata_Type/ImposteRimborsate**

diagram	
namespace	urn:www.agenziaentrate.gov.it:specificheTecniche:sco:p73
type	p73:Imposte_Rimborsate_Type
children	p73:TipoReddito p73:TassazioneSeparata

complexType **Redditi_Terreni_Type**

diagram	
namespace	urn:www.agenziaentrate.gov.it:specificheTecniche:sco:p73
children	p73:Modulo

element **Redditi_Terreni_Type/Modulo**

diagram	
namespace	urn:www.agenziaentrate.gov.it:specificheTecniche:sco:p73
type	p73:Modulo_Terreno_Type
children	p73:Terreno

complexType **Reddito_Erede_Type**

diagram	
namespace	urn:www.agenziaentrate.gov.it:specificheTecniche:sco:p73
type	extension of p73:Tassazione_Separata_Type

children	p73:Opzione p73:Anno p73:RedditoRitenute
----------	--

complexType Residuo_Credito_Compens_Annolmposta_Type

diagram	
namespace	urn:www.agenziaentrate.gov.it:specificheTecniche:sco:p73
type	extension of p73:Residuo_Credito_Compens_Type
children	p73:CreditoAnno p73:DiCuiCompensatoF24

complexType Residuo_Credito_Compens_Type

diagram	
namespace	urn:www.agenziaentrate.gov.it:specificheTecniche:sco:p73
children	p73:CreditoAnno p73:DiCuiCompensatoF24

element Residuo_Credito_Compens_Type/CreditoAnno

diagram					
namespace	urn:www.agenziaentrate.gov.it:specificheTecniche:sco:p73				
type	DatoNP_Type				
facets	<table border="1"> <tr> <td>Kind</td> <td>Value</td> </tr> <tr> <td>pattern</td> <td>[1-9]{1}[0-9]*</td> </tr> </table>	Kind	Value	pattern	[1-9]{1}[0-9]*
Kind	Value				
pattern	[1-9]{1}[0-9]*				

element Residuo_Credito_Compens_Type/DiCuiCompensatoF24

diagram					
namespace	urn:www.agenziaentrate.gov.it:specificheTecniche:sco:p73				
type	DatoNP_Type				
facets	<table border="1"> <tr> <td>Kind</td> <td>Value</td> </tr> <tr> <td>pattern</td> <td>[1-9]{1}[0-9]*</td> </tr> </table>	Kind	Value	pattern	[1-9]{1}[0-9]*
Kind	Value				
pattern	[1-9]{1}[0-9]*				

complexType Residuo_Fabbricati_Type

diagram	
namespace	urn:www.agenziaentrate.gov.it:specificheTecniche:sco:p73
children	p73:ResiduoPrecedenteDichiarazione p73:CreditoAnno p73:DiCuiCompensatoF24

element Residuo_Fabbricati_Type/ResiduoPrecedenteDichiarazione

diagram					
namespace	urn:www.agenziaentrate.gov.it:specificheTecniche:sco:p73				
type	DatoNP_Type				
facets	<table border="1"> <tr> <td>Kind</td> <td>Value</td> </tr> <tr> <td>pattern</td> <td>[1-9]{1}[0-9]*</td> </tr> </table>	Kind	Value	pattern	[1-9]{1}[0-9]*
Kind	Value				
pattern	[1-9]{1}[0-9]*				

element Residuo_Fabbricati_Type/CreditoAnno

diagram					
namespace	urn:www.agenziaentrate.gov.it:specificheTecniche:sco:p73				
type	DatoNP_Type				
facets	<table border="1"> <tr> <td>Kind</td> <td>Value</td> </tr> <tr> <td>pattern</td> <td>[1-9]{1}[0-9]*</td> </tr> </table>	Kind	Value	pattern	[1-9]{1}[0-9]*
Kind	Value				
pattern	[1-9]{1}[0-9]*				

element Residuo_Fabbricati_Type/DiCuiCompensatoF24

diagram					
namespace	urn:www.agenziaentrate.gov.it:specificheTecniche:sco:p73				
type	DatoNP_Type				
facets	<table border="1"> <tr> <td>Kind</td> <td>Value</td> </tr> <tr> <td>pattern</td> <td>[1-9]{1}[0-9]*</td> </tr> </table>	Kind	Value	pattern	[1-9]{1}[0-9]*
Kind	Value				
pattern	[1-9]{1}[0-9]*				

complexType Restituzione_Somme_Type

diagram	
namespace	urn:www.agenziaentrate.gov.it:specificheTecniche:sco:p73

children	p73:SommeRestituite p73:ResiduoPrecedenteDic
----------	--

element Restituzione_Somme_Type/SommeRestituite

diagram	
namespace	urn:www.agenziaentrate.gov.it:specificheTecniche:sco:p73
type	DatoNP_Type
facets	Kind Value pattern [1-9]{1}[0-9]*

element Restituzione_Somme_Type/ResiduoPrecedenteDic

diagram	
namespace	urn:www.agenziaentrate.gov.it:specificheTecniche:sco:p73
type	DatoNP_Type
facets	Kind Value pattern [1-9]{1}[0-9]*

complexType Riepilogo_Redditi_Type

diagram	
namespace	urn:www.agenziaentrate.gov.it:specificheTecniche:sco:p73
children	p73:Dominicali p73:Agrari p73:Fabbricati p73:LavDip p73:AltriRedditi p73:ImponibileCedolare p73:ImponibileCedolareOrdinario p73:ImponibileCedolareAgevolato p73:AbitazionePrincipalePertinenze

element **Riepilogo_Reddito_Type/Dominicali**

diagram					
namespace	urn:www.agenziaentrate.gov.it:specificheTecniche:sco:p73				
type	DatoNP_Type				
facets	<table border="1"> <tr> <td>Kind</td> <td>Value</td> </tr> <tr> <td>pattern</td> <td>[1-9]{1}[0-9]*</td> </tr> </table>	Kind	Value	pattern	[1-9]{1}[0-9]*
Kind	Value				
pattern	[1-9]{1}[0-9]*				

element **Riepilogo_Reddito_Type/Agrari**

diagram					
namespace	urn:www.agenziaentrate.gov.it:specificheTecniche:sco:p73				
type	DatoNP_Type				
facets	<table border="1"> <tr> <td>Kind</td> <td>Value</td> </tr> <tr> <td>pattern</td> <td>[1-9]{1}[0-9]*</td> </tr> </table>	Kind	Value	pattern	[1-9]{1}[0-9]*
Kind	Value				
pattern	[1-9]{1}[0-9]*				

element **Riepilogo_Reddito_Type/Fabbricati**

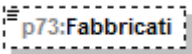
diagram					
namespace	urn:www.agenziaentrate.gov.it:specificheTecniche:sco:p73				
type	DatoNP_Type				
facets	<table border="1"> <tr> <td>Kind</td> <td>Value</td> </tr> <tr> <td>pattern</td> <td>[1-9]{1}[0-9]*</td> </tr> </table>	Kind	Value	pattern	[1-9]{1}[0-9]*
Kind	Value				
pattern	[1-9]{1}[0-9]*				

element **Riepilogo_Reddito_Type/LavDip**

diagram					
namespace	urn:www.agenziaentrate.gov.it:specificheTecniche:sco:p73				
type	DatoNP_Type				
facets	<table border="1"> <tr> <td>Kind</td> <td>Value</td> </tr> <tr> <td>pattern</td> <td>[1-9]{1}[0-9]*</td> </tr> </table>	Kind	Value	pattern	[1-9]{1}[0-9]*
Kind	Value				
pattern	[1-9]{1}[0-9]*				

element **Riepilogo_Reddito_Type/AltriRedditi**

diagram					
namespace	urn:www.agenziaentrate.gov.it:specificheTecniche:sco:p73				
type	DatoNP_Type				
facets	<table border="1"> <tr> <td>Kind</td> <td>Value</td> </tr> <tr> <td>pattern</td> <td>[1-9]{1}[0-9]*</td> </tr> </table>	Kind	Value	pattern	[1-9]{1}[0-9]*
Kind	Value				
pattern	[1-9]{1}[0-9]*				

element **Riepilogo_Reddit_Type/ImponibileCedolare**

diagram	 p73:ImponibileCedolare				
namespace	urn:www.agenziaentrate.gov.it:specificheTecniche:sco:p73				
type	DatoNP_Type				
facets	<table border="1"> <tr> <td>Kind</td> <td>Value</td> </tr> <tr> <td>pattern</td> <td>[1-9]{1}[0-9]*</td> </tr> </table>	Kind	Value	pattern	[1-9]{1}[0-9]*
Kind	Value				
pattern	[1-9]{1}[0-9]*				

element **Riepilogo_Reddit_Type/ImponibileCedolareOrdinario**

diagram	 p73:ImponibileCedolareOrdinario				
namespace	urn:www.agenziaentrate.gov.it:specificheTecniche:sco:p73				
type	DatoNP_Type				
facets	<table border="1"> <tr> <td>Kind</td> <td>Value</td> </tr> <tr> <td>pattern</td> <td>[1-9]{1}[0-9]*</td> </tr> </table>	Kind	Value	pattern	[1-9]{1}[0-9]*
Kind	Value				
pattern	[1-9]{1}[0-9]*				

element **Riepilogo_Reddit_Type/ImponibileCedolareAgevolato**

diagram	 p73:ImponibileCedolareAgevolato				
namespace	urn:www.agenziaentrate.gov.it:specificheTecniche:sco:p73				
type	DatoNP_Type				
facets	<table border="1"> <tr> <td>Kind</td> <td>Value</td> </tr> <tr> <td>pattern</td> <td>[1-9]{1}[0-9]*</td> </tr> </table>	Kind	Value	pattern	[1-9]{1}[0-9]*
Kind	Value				
pattern	[1-9]{1}[0-9]*				

element **Riepilogo_Reddit_Type/AbitazionePrincipalePertinenze**

diagram	 p73:AbitazionePrincipalePertine...				
namespace	urn:www.agenziaentrate.gov.it:specificheTecniche:sco:p73				
type	DatoNP_Type				
facets	<table border="1"> <tr> <td>Kind</td> <td>Value</td> </tr> <tr> <td>pattern</td> <td>[1-9]{1}[0-9]*</td> </tr> </table>	Kind	Value	pattern	[1-9]{1}[0-9]*
Kind	Value				
pattern	[1-9]{1}[0-9]*				

complexType **Ritenute_Acconti_Sospesi_Type**

diagram	
namespace	urn:www.agenziaentrate.gov.it:specificheTecniche:sco:p73
children	p73:CodiceEvento p73:lrpef p73:AddRegionalelrpef p73:AddComunalelrpef p73:SostitutivaPremi p73:CedolareSecca p73:ContribSolidarieta

element **Ritenute_Acconti_Sospesi_Type/CodiceEvento**

diagram																	
namespace	urn:www.agenziaentrate.gov.it:specificheTecniche:sco:p73																
type	p73:Codice Evento Eccezionale Type																
facets	<table border="1"> <thead> <tr> <th>Kind</th> <th>Value</th> </tr> </thead> <tbody> <tr> <td>pattern</td> <td>[1-9]{1}[0-9]*</td> </tr> <tr> <td>enumeration</td> <td>1</td> </tr> <tr> <td>enumeration</td> <td>2</td> </tr> <tr> <td>enumeration</td> <td>3</td> </tr> <tr> <td>enumeration</td> <td>4</td> </tr> <tr> <td>enumeration</td> <td>5</td> </tr> <tr> <td>enumeration</td> <td>6</td> </tr> </tbody> </table>	Kind	Value	pattern	[1-9]{1}[0-9]*	enumeration	1	enumeration	2	enumeration	3	enumeration	4	enumeration	5	enumeration	6
Kind	Value																
pattern	[1-9]{1}[0-9]*																
enumeration	1																
enumeration	2																
enumeration	3																
enumeration	4																
enumeration	5																
enumeration	6																

element **Ritenute_Acconti_Sospesi_Type/lrpef**

diagram					
namespace	urn:www.agenziaentrate.gov.it:specificheTecniche:sco:p73				
type	DatoNP Type				
facets	<table border="1"> <thead> <tr> <th>Kind</th> <th>Value</th> </tr> </thead> <tbody> <tr> <td>pattern</td> <td>[1-9]{1}[0-9]*</td> </tr> </tbody> </table>	Kind	Value	pattern	[1-9]{1}[0-9]*
Kind	Value				
pattern	[1-9]{1}[0-9]*				

element **Ritenute_Acconti_Sospesi_Type/AddRegionalelrpef**

diagram	
namespace	urn:www.agenziaentrate.gov.it:specificheTecniche:sco:p73

type	DatoNP_Type
facets	Kind Value pattern [1-9]{1}[0-9]*

element Ritenute_Acconti_Sospesi_Type/AddComunalelrpef

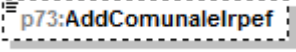
diagram	
namespace	urn:www.agenziaentrate.gov.it:specificheTecniche:sco:p73
type	DatoNP_Type
facets	Kind Value pattern [1-9]{1}[0-9]*

element Ritenute_Acconti_Sospesi_Type/SostitutivaPremi

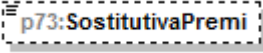
diagram	
namespace	urn:www.agenziaentrate.gov.it:specificheTecniche:sco:p73
type	DatoNP_Type
facets	Kind Value pattern [1-9]{1}[0-9]*

element Ritenute_Acconti_Sospesi_Type/CedolareSecca

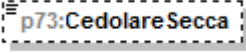
diagram	
namespace	urn:www.agenziaentrate.gov.it:specificheTecniche:sco:p73
type	DatoNP_Type
facets	Kind Value pattern [1-9]{1}[0-9]*

element Ritenute_Acconti_Sospesi_Type/ContribSolidarieta

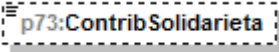
diagram	
namespace	urn:www.agenziaentrate.gov.it:specificheTecniche:sco:p73
type	DatoNP_Type
facets	Kind Value pattern [1-9]{1}[0-9]*

complexType **Ritenute_Lavoro_Dip_Type**

diagram	
namespace	urn:www.agenziaentrate.gov.it:specificheTecniche:sco:p73
children	p73:Ritlrpef p73:RitAddRegionale p73:RitAccAddComunale p73:RitSaldoAddComunale p73:RitAccAddComAnnoPres

element **Ritenute_Lavoro_Dip_Type/Ritlrpef**

diagram					
namespace	urn:www.agenziaentrate.gov.it:specificheTecniche:sco:p73				
type	DatoNP_Type				
facets	<table border="1"> <tr> <td>Kind</td> <td>Value</td> </tr> <tr> <td>pattern</td> <td>[1-9]{1}[0-9]*</td> </tr> </table>	Kind	Value	pattern	[1-9]{1}[0-9]*
Kind	Value				
pattern	[1-9]{1}[0-9]*				

element **Ritenute_Lavoro_Dip_Type/RitAddRegionale**

diagram					
namespace	urn:www.agenziaentrate.gov.it:specificheTecniche:sco:p73				
type	DatoNP_Type				
facets	<table border="1"> <tr> <td>Kind</td> <td>Value</td> </tr> <tr> <td>pattern</td> <td>[1-9]{1}[0-9]*</td> </tr> </table>	Kind	Value	pattern	[1-9]{1}[0-9]*
Kind	Value				
pattern	[1-9]{1}[0-9]*				

element **Ritenute_Lavoro_Dip_Type/RitAccAddComunale**

diagram					
namespace	urn:www.agenziaentrate.gov.it:specificheTecniche:sco:p73				
type	DatoNP_Type				
facets	<table border="1"> <tr> <td>Kind</td> <td>Value</td> </tr> <tr> <td>pattern</td> <td>[1-9]{1}[0-9]*</td> </tr> </table>	Kind	Value	pattern	[1-9]{1}[0-9]*
Kind	Value				
pattern	[1-9]{1}[0-9]*				

element Ritenute_Lavoro_Dip_Type/RitSaldoAddComunale

diagram	
namespace	urn:www.agenziaentrate.gov.it:specificheTecniche:sco:p73
type	DatoNP_Type
facets	Kind Value pattern [1-9]{1}[0-9]*

element Ritenute_Lavoro_Dip_Type/RitAccAddComAnnoPres

diagram	
namespace	urn:www.agenziaentrate.gov.it:specificheTecniche:sco:p73
type	DatoNP_Type
facets	Kind Value pattern [1-9]{1}[0-9]*

complexType Sezione_Altri_Redd_Type

diagram	
namespace	urn:www.agenziaentrate.gov.it:specificheTecniche:sco:p73
children	p73:TipoReddito p73:RedditiRitenute

element Sezione_Altri_Redd_Type/TipoReddito

diagram	
namespace	urn:www.agenziaentrate.gov.it:specificheTecniche:sco:p73
type	p73:Tipo Reddito Da1a8_Type
facets	Kind Value pattern [1-9]{1}[0-9]* enumeration 1 enumeration 2 enumeration 3 enumeration 4 enumeration 5 enumeration 6 enumeration 7 enumeration 8

element **Sezione_Altri_Redd_Type/RedditiRitenute**

diagram	
namespace	urn:www.agenziaentrate.gov.it:specificheTecniche:sco:p73
type	p73:Redditi_Ritenute_Type
children	p73:ImportoRedditi p73:ImportoRitenute

complexType **Sezione_Dati_Catastali_Recupero_Patrimonio_Edilizio_Type**

diagram	
namespace	urn:www.agenziaentrate.gov.it:specificheTecniche:sco:p73
children	p73:DatiCatastaliRecuperoPatrimonioEdilizio p73:DatiRegistrazioneAccatamentoRecuperoPatrimonio_Edilizio

element **Sezione_Dati_Catastali_Recupero_Patrimonio_Edilizio_Type/DatiCatastaliRecuperoPatrimonioEdilizio**

diagram	
namespace	urn:www.agenziaentrate.gov.it:specificheTecniche:sco:p73
type	extension of p73:Dati_Catastali_Recupero_Patrimonio_Edilizio_Type
children	p73:NORDImmobile p73:Condominio p73:DatiCatastali

element

Sezione_Dati_Catastali_Recupero_Patrimonio_Edilizio_Type/DatiRegistrazioneAccatastamentoRecuperoPatrimonio_Edilizio

diagram	
namespace	urn:www.agenziaentrate.gov.it:specificheTecniche:sco:p73
type	p73:Dati_Registrazione_Accatastamento_Recupero_Patrimonio_Edilizio_Type
children	p73:NOrdImmobile p73:Condominio p73:EstremiRegistrazioneContratto p73:DomandaAccatastamento

complexType **Soggetto_Fiscale_730_Type**

diagram	
namespace	urn:www.agenziaentrate.gov.it:specificheTecniche:sco:p73
children	p73:CodiceFiscale p73:Email p73:Telefono p73:Cellulare

element **Soggetto_Fiscale_730_Type/CodiceFiscale**

diagram					
namespace	urn:www.agenziaentrate.gov.it:specificheTecniche:sco:p73				
type	DatoCF_Type				
facets	<table border="1"> <thead> <tr> <th>Kind</th> <th>Value</th> </tr> </thead> <tbody> <tr> <td>pattern</td> <td>[0-9]{11}[A-Z]{6}[0-9LMNPQRSTU]{2}[A-Z]{1}[0-9LMNPQRSTU]{2}[A-Z]{1}[0-9LMNPQRSTU]{3}[A-Z]{1}</td> </tr> </tbody> </table>	Kind	Value	pattern	[0-9]{11}[A-Z]{6}[0-9LMNPQRSTU]{2}[A-Z]{1}[0-9LMNPQRSTU]{2}[A-Z]{1}[0-9LMNPQRSTU]{3}[A-Z]{1}
Kind	Value				
pattern	[0-9]{11}[A-Z]{6}[0-9LMNPQRSTU]{2}[A-Z]{1}[0-9LMNPQRSTU]{2}[A-Z]{1}[0-9LMNPQRSTU]{3}[A-Z]{1}				

element **Soggetto_Fiscale_730_Type/Email**

diagram	
namespace	urn:www.agenziaentrate.gov.it:specificheTecniche:sco:p73
type	DatoEM_Type

facets	Kind pattern	Value [a-zA-Z0-9._%'\-'\"?^~=]+@[a-zA-Z0-9.\-]\.[a-zA-Z]{2,4}
--------	-----------------	---

element **Soggetto_Fiscale_730_Type/Telefono**

diagram		
namespace	urn:www.agenziaentrate.gov.it:specificheTecniche:sco:p73	
type	DatoAN_Type	
facets	Kind pattern	Value ([0-9A-Z-]\"){1}([0-9A-Z&] \- \., / \^\(\ \)\ À È É Ì Ò Ù Û " \N \+)*

element **Soggetto_Fiscale_730_Type/Cellulare**

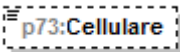
diagram		
namespace	urn:www.agenziaentrate.gov.it:specificheTecniche:sco:p73	
type	DatoAN_Type	
facets	Kind pattern	Value ([0-9A-Z-]\"){1}([0-9A-Z&] \- \., / \^\(\ \)\ À È É Ì Ò Ù Û " \N \+)*

complexType **Soglie_Esenzione_Type**

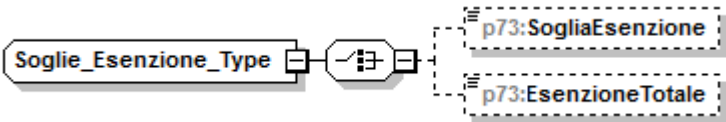
diagram		
namespace	urn:www.agenziaentrate.gov.it:specificheTecniche:sco:p73	
children	p73:SogliaEsenzione p73:EsenzioneTotale	

element **Soglie_Esenzione_Type/SogliaEsenzione**

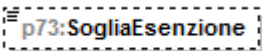
diagram		
namespace	urn:www.agenziaentrate.gov.it:specificheTecniche:sco:p73	
type	DatoNP_Type	
facets	Kind pattern	Value [1-9]{1}[0-9]*

element **Soglie_Esenzione_Type/EsenzioneTotale**

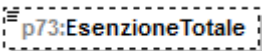
diagram		
namespace	urn:www.agenziaentrate.gov.it:specificheTecniche:sco:p73	

type	restriction of DatoN1_Type	
facets	Kind	Value
	pattern	[1-9]
	enumeration	1
	enumeration	2

complexType **Spese_Arredo_Giovani_Coppie_Type**

diagram	
namespace	urn:www.agenziaentrate.gov.it:specificheTecniche:sco:p73
children	p73:Meno35Anni p73:NumeroRata p73:Importo

element **Spese_Arredo_Giovani_Coppie_Type/Meno35Anni**

diagram	
namespace	urn:www.agenziaentrate.gov.it:specificheTecniche:sco:p73
type	DatoCB_Type
facets	Kind Value pattern [01]

element **Spese_Arredo_Giovani_Coppie_Type/NumeroRata**

diagram	
namespace	urn:www.agenziaentrate.gov.it:specificheTecniche:sco:p73
type	restriction of DatoNP_Type
facets	Kind Value pattern [1-9]{1}[0-9]* enumeration 1

element **Spese_Arredo_Giovani_Coppie_Type/Importo**

diagram	
namespace	urn:www.agenziaentrate.gov.it:specificheTecniche:sco:p73
type	DatoNP_Type
facets	Kind Value pattern [1-9]{1}[0-9]*

complexType Spese_Arredo_Type

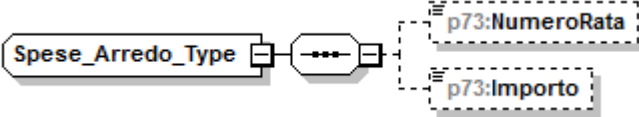
diagram	
namespace	urn:www.agenziaentrate.gov.it:specificheTecniche:sco:p73
children	p73:NumeroRata p73:Importo

element Spese_Arredo_Type/NumeroRata

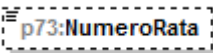
diagram											
namespace	urn:www.agenziaentrate.gov.it:specificheTecniche:sco:p73										
type	p73:Numero_RateDa1A3_Type										
facets	<table border="0"> <tr> <td>Kind</td> <td>Value</td> </tr> <tr> <td>pattern</td> <td>[1-9]</td> </tr> <tr> <td>enumeration</td> <td>1</td> </tr> <tr> <td>enumeration</td> <td>2</td> </tr> <tr> <td>enumeration</td> <td>3</td> </tr> </table>	Kind	Value	pattern	[1-9]	enumeration	1	enumeration	2	enumeration	3
Kind	Value										
pattern	[1-9]										
enumeration	1										
enumeration	2										
enumeration	3										

element Spese_Arredo_Type/Importo

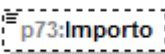
diagram					
namespace	urn:www.agenziaentrate.gov.it:specificheTecniche:sco:p73				
type	DatoNP_Type				
facets	<table border="0"> <tr> <td>Kind</td> <td>Value</td> </tr> <tr> <td>pattern</td> <td>[1-9]{1}[0-9]*</td> </tr> </table>	Kind	Value	pattern	[1-9]{1}[0-9]*
Kind	Value				
pattern	[1-9]{1}[0-9]*				

complexType Spese_Leasing_Type

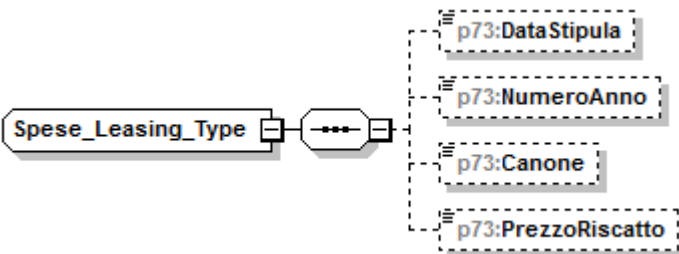
diagram	
namespace	urn:www.agenziaentrate.gov.it:specificheTecniche:sco:p73
children	p73:DataStipula p73:NumeroAnno p73:Canone p73:PrezzoRiscatto

element **Spese_Leasing_Type/DataStipula**

diagram					
namespace	urn:www.agenziaentrate.gov.it:specificheTecniche:sco:p73				
type	DatoDT_Type				
facets	<table border="1"> <thead> <tr> <th>Kind</th> <th>Value</th> </tr> </thead> <tbody> <tr> <td>pattern</td> <td>((([0-9]{12}[0-9]{3}[01])([0-9]{10}[12](\d{4})) ([0-9]{1-9}[12][0-9]{30})([0-9]{11}(\d{4})) ([0-9]{1}[0-9]{2}[0-8])([0-9]{2}(\d{4})) ((29)(02)([0-9]{2468}[048]00)) ((29)(02)([1-9]{26}00)) ((29)(02)([0-9]{0-9}[0]48)) ((29)(02)([0-9]{0-9}[2468][048])) ((29)(02)([0-9]{0-9}[13579][26]))))</td> </tr> </tbody> </table>	Kind	Value	pattern	((([0-9]{12}[0-9]{3}[01])([0-9]{10}[12](\d{4})) ([0-9]{1-9}[12][0-9]{30})([0-9]{11}(\d{4})) ([0-9]{1}[0-9]{2}[0-8])([0-9]{2}(\d{4})) ((29)(02)([0-9]{2468}[048]00)) ((29)(02)([1-9]{26}00)) ((29)(02)([0-9]{0-9}[0]48)) ((29)(02)([0-9]{0-9}[2468][048])) ((29)(02)([0-9]{0-9}[13579][26]))))
Kind	Value				
pattern	((([0-9]{12}[0-9]{3}[01])([0-9]{10}[12](\d{4})) ([0-9]{1-9}[12][0-9]{30})([0-9]{11}(\d{4})) ([0-9]{1}[0-9]{2}[0-8])([0-9]{2}(\d{4})) ((29)(02)([0-9]{2468}[048]00)) ((29)(02)([1-9]{26}00)) ((29)(02)([0-9]{0-9}[0]48)) ((29)(02)([0-9]{0-9}[2468][048])) ((29)(02)([0-9]{0-9}[13579][26]))))				

element **Spese_Leasing_Type/NumeroAnno**

diagram							
namespace	urn:www.agenziaentrate.gov.it:specificheTecniche:sco:p73						
type	restriction of DatoNP_Type						
facets	<table border="1"> <thead> <tr> <th>Kind</th> <th>Value</th> </tr> </thead> <tbody> <tr> <td>pattern</td> <td>[1-9]{1}[0-9]*</td> </tr> <tr> <td>enumeration</td> <td>1</td> </tr> </tbody> </table>	Kind	Value	pattern	[1-9]{1}[0-9]*	enumeration	1
Kind	Value						
pattern	[1-9]{1}[0-9]*						
enumeration	1						

element **Spese_Leasing_Type/Canone**

diagram					
namespace	urn:www.agenziaentrate.gov.it:specificheTecniche:sco:p73				
type	restriction of DatoNP_Type				
facets	<table border="1"> <thead> <tr> <th>Kind</th> <th>Value</th> </tr> </thead> <tbody> <tr> <td>pattern</td> <td>[1-9]{1}[0-9]*</td> </tr> </tbody> </table>	Kind	Value	pattern	[1-9]{1}[0-9]*
Kind	Value				
pattern	[1-9]{1}[0-9]*				

element **Spese_Leasing_Type/PrezzoRiscatto**

diagram					
namespace	urn:www.agenziaentrate.gov.it:specificheTecniche:sco:p73				
type	restriction of DatoNP_Type				
facets	<table border="1"> <thead> <tr> <th>Kind</th> <th>Value</th> </tr> </thead> <tbody> <tr> <td>pattern</td> <td>[1-9]{1}[0-9]*</td> </tr> </tbody> </table>	Kind	Value	pattern	[1-9]{1}[0-9]*
Kind	Value				
pattern	[1-9]{1}[0-9]*				

complexType **Spese_Rateizzate_Anni_Precedenti_Type**

diagram	
namespace	urn:www.agenziaentrate.gov.it:specificheTecniche:sco:p73

children	p73:Codice p73:Importo
----------	--

element Spese_Rateizzate_Anni_Precedenti_Type/Codice

diagram											
namespace	urn:www.agenziaentrate.gov.it:specificheTecniche:sco:p73										
type	p73:Codice Spese Rateizzate Anni Precedenti Type										
facets	<table border="1"> <thead> <tr> <th>Kind</th> <th>Value</th> </tr> </thead> <tbody> <tr> <td>pattern</td> <td>[1-9]{1}[0-9]*</td> </tr> <tr> <td>enumeration</td> <td>2</td> </tr> <tr> <td>enumeration</td> <td>3</td> </tr> <tr> <td>enumeration</td> <td>4</td> </tr> </tbody> </table>	Kind	Value	pattern	[1-9]{1}[0-9]*	enumeration	2	enumeration	3	enumeration	4
Kind	Value										
pattern	[1-9]{1}[0-9]*										
enumeration	2										
enumeration	3										
enumeration	4										

element Spese_Rateizzate_Anni_Precedenti_Type/Importo

diagram					
namespace	urn:www.agenziaentrate.gov.it:specificheTecniche:sco:p73				
type	DatoNP Type				
facets	<table border="1"> <thead> <tr> <th>Kind</th> <th>Value</th> </tr> </thead> <tbody> <tr> <td>pattern</td> <td>[1-9]{1}[0-9]*</td> </tr> </tbody> </table>	Kind	Value	pattern	[1-9]{1}[0-9]*
Kind	Value				
pattern	[1-9]{1}[0-9]*				

complexType Spese_Rateizzate_Type

diagram	
namespace	urn:www.agenziaentrate.gov.it:specificheTecniche:sco:p73
children	p73:Codice p73:Importo

element Spese_Rateizzate_Type/Codice

diagram													
namespace	urn:www.agenziaentrate.gov.it:specificheTecniche:sco:p73												
type	p73:Codice Spese Rateizzate Type												
facets	<table border="1"> <thead> <tr> <th>Kind</th> <th>Value</th> </tr> </thead> <tbody> <tr> <td>pattern</td> <td>[1-9]{1}[0-9]*</td> </tr> <tr> <td>enumeration</td> <td>1</td> </tr> <tr> <td>enumeration</td> <td>2</td> </tr> <tr> <td>enumeration</td> <td>3</td> </tr> <tr> <td>enumeration</td> <td>4</td> </tr> </tbody> </table>	Kind	Value	pattern	[1-9]{1}[0-9]*	enumeration	1	enumeration	2	enumeration	3	enumeration	4
Kind	Value												
pattern	[1-9]{1}[0-9]*												
enumeration	1												
enumeration	2												
enumeration	3												
enumeration	4												

element Spese_Rateizzate_Type/Importo

diagram	
namespace	urn:www.agenziaentrate.gov.it:specificheTecniche:sco:p73
type	DatoNP_Type
facets	Kind Value pattern [1-9]{1}[0-9]*

complexType Tassazione_Separata_Type

diagram	
namespace	urn:www.agenziaentrate.gov.it:specificheTecniche:sco:p73
children	p73:Opzione p73:Anno p73:RedditoRitenute

element Tassazione_Separata_Type/Opzione

diagram	
namespace	urn:www.agenziaentrate.gov.it:specificheTecniche:sco:p73
type	DatoCB_Type
facets	Kind Value pattern [01]

element Tassazione_Separata_Type/Anno

diagram	
namespace	urn:www.agenziaentrate.gov.it:specificheTecniche:sco:p73
type	DatoDA_Type
facets	Kind Value pattern (18 19 20)[0-9]{2}

element **Tassazione_Separata_Type/RedditoRitenute**

diagram	
namespace	urn:www.agenziaentrate.gov.it:specificheTecniche:sco:p73
type	p73:Redditi_Ritenute_Type
children	p73:ImportoRedditi p73:ImportoRitenute

complexType **Terreno_Type**

diagram	
namespace	urn:www.agenziaentrate.gov.it:specificheTecniche:sco:p73
children	p73:RedDominicale p73:Titolo p73:RedAgrario p73:GiorniPossesso p73:PercPossesso p73:CanoneVincolistico p73:CasiParticolari p73:CasellaContinuazione p73:CasellalmuNonDovuta p73:CasellaColtivatoreDiretto

element **Terreno_Type/RedDominicale**

diagram					
namespace	urn:www.agenziaentrate.gov.it:specificheTecniche:sco:p73				
type	DatoNP_Type				
facets	<table border="1"> <thead> <tr> <th>Kind</th> <th>Value</th> </tr> </thead> <tbody> <tr> <td>pattern</td> <td>[1-9]{1}[0-9]*</td> </tr> </tbody> </table>	Kind	Value	pattern	[1-9]{1}[0-9]*
Kind	Value				
pattern	[1-9]{1}[0-9]*				

element Terreno_Type/Titolo

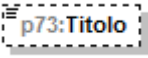
diagram																									
namespace	urn:www.agenziaentrate.gov.it:specificheTecniche:sco:p73																								
type	p73:Titolo_Terreno_Type																								
facets	<table border="0"> <thead> <tr> <th>Kind</th> <th>Value</th> </tr> </thead> <tbody> <tr> <td>pattern</td> <td>[1-9]{1}[0-9]*</td> </tr> <tr> <td>enumeration</td> <td>1</td> </tr> <tr> <td>enumeration</td> <td>2</td> </tr> <tr> <td>enumeration</td> <td>3</td> </tr> <tr> <td>enumeration</td> <td>4</td> </tr> <tr> <td>enumeration</td> <td>5</td> </tr> <tr> <td>enumeration</td> <td>6</td> </tr> <tr> <td>enumeration</td> <td>7</td> </tr> <tr> <td>enumeration</td> <td>8</td> </tr> <tr> <td>enumeration</td> <td>9</td> </tr> <tr> <td>enumeration</td> <td>10</td> </tr> </tbody> </table>	Kind	Value	pattern	[1-9]{1}[0-9]*	enumeration	1	enumeration	2	enumeration	3	enumeration	4	enumeration	5	enumeration	6	enumeration	7	enumeration	8	enumeration	9	enumeration	10
Kind	Value																								
pattern	[1-9]{1}[0-9]*																								
enumeration	1																								
enumeration	2																								
enumeration	3																								
enumeration	4																								
enumeration	5																								
enumeration	6																								
enumeration	7																								
enumeration	8																								
enumeration	9																								
enumeration	10																								

element Terreno_Type/RedAgrario

diagram					
namespace	urn:www.agenziaentrate.gov.it:specificheTecniche:sco:p73				
type	DatoNP_Type				
facets	<table border="0"> <thead> <tr> <th>Kind</th> <th>Value</th> </tr> </thead> <tbody> <tr> <td>pattern</td> <td>[1-9]{1}[0-9]*</td> </tr> </tbody> </table>	Kind	Value	pattern	[1-9]{1}[0-9]*
Kind	Value				
pattern	[1-9]{1}[0-9]*				

element Terreno_Type/GiorniPossesso

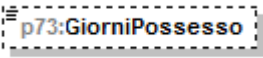
diagram					
namespace	urn:www.agenziaentrate.gov.it:specificheTecniche:sco:p73				
type	DatoGA_Type				
facets	<table border="0"> <thead> <tr> <th>Kind</th> <th>Value</th> </tr> </thead> <tbody> <tr> <td>pattern</td> <td>[1-9](((1-9)[0-9]) ((12)[0-9][0-9]) (3[0-5][0-9]) (36[0-5]))</td> </tr> </tbody> </table>	Kind	Value	pattern	[1-9](((1-9)[0-9]) ((12)[0-9][0-9]) (3[0-5][0-9]) (36[0-5]))
Kind	Value				
pattern	[1-9](((1-9)[0-9]) ((12)[0-9][0-9]) (3[0-5][0-9]) (36[0-5]))				

element Terreno_Type/PercPossesso

diagram					
namespace	urn:www.agenziaentrate.gov.it:specificheTecniche:sco:p73				
type	DatoPC_Type				
facets	<table border="0"> <thead> <tr> <th>Kind</th> <th>Value</th> </tr> </thead> <tbody> <tr> <td>pattern</td> <td>[0-9]?[0-9](,\\d{1,3})? 100,(0{1,3})?</td> </tr> </tbody> </table>	Kind	Value	pattern	[0-9]?[0-9](,\\d{1,3})? 100,(0{1,3})?
Kind	Value				
pattern	[0-9]?[0-9](,\\d{1,3})? 100,(0{1,3})?				

element **Terreno_Type/CanoneVincolistico**

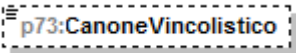
diagram					
namespace	urn:www.agenziaentrate.gov.it:specificheTecniche:sco:p73				
type	DatoNP_Type				
facets	<table border="1"> <thead> <tr> <th>Kind</th> <th>Value</th> </tr> </thead> <tbody> <tr> <td>pattern</td> <td>[1-9]{1}[0-9]*</td> </tr> </tbody> </table>	Kind	Value	pattern	[1-9]{1}[0-9]*
Kind	Value				
pattern	[1-9]{1}[0-9]*				

element **Terreno_Type/CasiParticolari**

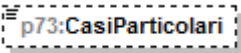
diagram													
namespace	urn:www.agenziaentrate.gov.it:specificheTecniche:sco:p73												
type	p73:Casi_Particolari_Terreni_Type												
facets	<table border="1"> <thead> <tr> <th>Kind</th> <th>Value</th> </tr> </thead> <tbody> <tr> <td>pattern</td> <td>[1-9]</td> </tr> <tr> <td>enumeration</td> <td>2</td> </tr> <tr> <td>enumeration</td> <td>3</td> </tr> <tr> <td>enumeration</td> <td>4</td> </tr> <tr> <td>enumeration</td> <td>6</td> </tr> </tbody> </table>	Kind	Value	pattern	[1-9]	enumeration	2	enumeration	3	enumeration	4	enumeration	6
Kind	Value												
pattern	[1-9]												
enumeration	2												
enumeration	3												
enumeration	4												
enumeration	6												

element **Terreno_Type/CasellaContinuazione**

diagram					
namespace	urn:www.agenziaentrate.gov.it:specificheTecniche:sco:p73				
type	DatoCB_Type				
facets	<table border="1"> <thead> <tr> <th>Kind</th> <th>Value</th> </tr> </thead> <tbody> <tr> <td>pattern</td> <td>[01]</td> </tr> </tbody> </table>	Kind	Value	pattern	[01]
Kind	Value				
pattern	[01]				

element **Terreno_Type/CasellalmuNonDovuta**

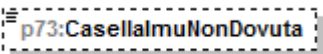
diagram					
namespace	urn:www.agenziaentrate.gov.it:specificheTecniche:sco:p73				
type	DatoCB_Type				
facets	<table border="1"> <thead> <tr> <th>Kind</th> <th>Value</th> </tr> </thead> <tbody> <tr> <td>pattern</td> <td>[01]</td> </tr> </tbody> </table>	Kind	Value	pattern	[01]
Kind	Value				
pattern	[01]				

element **Terreno_Type/CasellaColtivatoreDiretto**

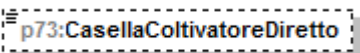
diagram	
namespace	urn:www.agenziaentrate.gov.it:specificheTecniche:sco:p73
type	DatoCB_Type

facets	Kind	Value
	pattern	[01]

simpleType Anno_Anticipazione_Fondo_Pensione_Type

namespace	urn:www.agenziaentrate.gov.it:specificheTecniche:sco:p73	
type	restriction of DatoNP_Type	
facets	Kind	Value
	pattern	[1-9]{1}[0-9]*
	enumeration	2007
	enumeration	2008
	enumeration	2009
	enumeration	2010
	enumeration	2011
	enumeration	2012
	enumeration	2013
	enumeration	2014
	enumeration	2015
	enumeration	2016

simpleType Anno_Patrimonio_Edilizio_Situazioni_Particolari_Type

namespace	urn:www.agenziaentrate.gov.it:specificheTecniche:sco:p73	
type	restriction of DatoNP_Type	
facets	Kind	Value
	pattern	[1-9]{1}[0-9]*
	enumeration	2011

simpleType Anno_Recupero_Patrimonio_Edilizio_Type

namespace	urn:www.agenziaentrate.gov.it:specificheTecniche:sco:p73	
type	restriction of DatoNP_Type	
facets	Kind	Value
	pattern	[1-9]{1}[0-9]*
	enumeration	2007
	enumeration	2008
	enumeration	2009
	enumeration	2010
	enumeration	2011
	enumeration	2012
	enumeration	2013
	enumeration	2014
	enumeration	2015
	enumeration	2016

simpleType Anno_Risparmio_Energetico_Type

namespace	urn:www.agenziaentrate.gov.it:specificheTecniche:sco:p73	
type	restriction of DatoNP_Type	
facets	Kind	Value
	pattern	[1-9]{1}[0-9]*
	enumeration	2008
	enumeration	2011
	enumeration	2012
	enumeration	2013
	enumeration	2014
	enumeration	2015

	enumeration	2016
--	-------------	------

simpleType Casella_Codice_Type

namespace	urn:www.agenziaentrate.gov.it:specificheTecniche:sco:p73	
type	restriction of DatoN1_Type	
facets	Kind	Value
	pattern	[1-9]
	enumeration	4

simpleType Casi_Particolari_Fabbricato_Type

namespace	urn:www.agenziaentrate.gov.it:specificheTecniche:sco:p73	
type	restriction of DatoN1_Type	
facets	Kind	Value
	pattern	[1-9]
	enumeration	1
	enumeration	3
	enumeration	4
	enumeration	5

simpleType Casi_Particolari_Risp_Ener_Type

namespace	urn:www.agenziaentrate.gov.it:specificheTecniche:sco:p73	
type	restriction of DatoN1_Type	
facets	Kind	Value
	pattern	[1-9]
	enumeration	1
	enumeration	2
	enumeration	3

simpleType Casi_Particolari_Terreni_Type

namespace	urn:www.agenziaentrate.gov.it:specificheTecniche:sco:p73	
type	restriction of DatoN1_Type	
facets	Kind	Value
	pattern	[1-9]
	enumeration	2
	enumeration	3
	enumeration	4
	enumeration	6

simpleType Codice_Altre_Detrazioni_Type

namespace	urn:www.agenziaentrate.gov.it:specificheTecniche:sco:p73	
type	restriction of DatoNP_Type	
facets	Kind	Value
	pattern	[1-9]{1}[0-9]*
	enumeration	1
	enumeration	2

simpleType Codice_Altre_Spese_Type

namespace	urn:www.agenziaentrate.gov.it:specificheTecniche:sco:p73	
type	restriction of DatoNP_Type	
facets	Kind	Value
	pattern	[1-9]{1}[0-9]*
	enumeration	8
	enumeration	9
	enumeration	10
	enumeration	11
	enumeration	12
	enumeration	13
	enumeration	14
	enumeration	15
	enumeration	16
	enumeration	17
	enumeration	18
	enumeration	20
	enumeration	21
	enumeration	22
	enumeration	23
	enumeration	24
	enumeration	25
	enumeration	26
	enumeration	27
	enumeration	28
	enumeration	29
	enumeration	30
	enumeration	31
	enumeration	32
	enumeration	33
	enumeration	35
	enumeration	36
	enumeration	38
	enumeration	39
	enumeration	41
	enumeration	42
	enumeration	99

simpleType Codice_Altri_Oneri_Type

namespace	urn:www.agenziaentrate.gov.it:specificheTecniche:sco:p73	
type	restriction of DatoNP_Type	
facets	Kind	Value
	pattern	[1-9]{1}[0-9]*
	enumeration	6
	enumeration	7
	enumeration	8
	enumeration	9
	enumeration	12
	enumeration	13
	enumeration	21

simpleType Codice_Canone_Type

namespace	urn:www.agenziaentrate.gov.it:specificheTecniche:sco:p73	
type	restriction of DatoN1_Type	
facets	Kind	Value
	pattern	[1-9]
	enumeration	1
	enumeration	2
	enumeration	3

	enumeration	4
--	-------------	---

simpleType Codice_Evento_Eccezionale_Type

namespace	urn:www.agenziaentrate.gov.it:specificheTecniche:sco:p73	
type	restriction of DatoNP_Type	
facets	Kind	Value
	pattern	[1-9]{1}[0-9]*
	enumeration	1
	enumeration	2
	enumeration	3
	enumeration	4
	enumeration	5
	enumeration	6

simpleType Codice_Spese_Rateizzate_Anni_Precedenti_Type

namespace	urn:www.agenziaentrate.gov.it:specificheTecniche:sco:p73	
type	restriction of DatoNP_Type	
facets	Kind	Value
	pattern	[1-9]{1}[0-9]*
	enumeration	2
	enumeration	3
	enumeration	4

simpleType Codice_Spese_Rateizzate_Type

namespace	urn:www.agenziaentrate.gov.it:specificheTecniche:sco:p73	
type	restriction of DatoNP_Type	
facets	Kind	Value
	pattern	[1-9]{1}[0-9]*
	enumeration	1
	enumeration	2
	enumeration	3
	enumeration	4

simpleType Fabbricato_Agev_Numero_Rigo_Type

namespace	urn:www.agenziaentrate.gov.it:specificheTecniche:sco:p73	
type	restriction of DatoNP_Type	
facets	Kind	Value
	pattern	[1-9]{1}[0-9]*
	enumeration	1
	enumeration	2
	enumeration	3
	enumeration	4
	enumeration	5
	enumeration	6
	enumeration	7
	enumeration	8
	enumeration	9
	enumeration	10

simpleType Indeterminato_Determinato_Type

namespace	urn:www.agenziaentrate.gov.it:specificheTecniche:sco:p73	
type	restriction of DatoN1_Type	
facets	Kind	Value
	pattern	[1-9]
	enumeration	1
	enumeration	2

simpleType Mesi_Type

namespace	urn:www.agenziaentrate.gov.it:specificheTecniche:sco:p73	
type	restriction of DatoNP_Type	
facets	Kind	Value
	pattern	[1-9]{1}[0-9]*
	enumeration	1
	enumeration	2
	enumeration	3
	enumeration	4
	enumeration	5
	enumeration	6
	enumeration	7
	enumeration	8
	enumeration	9
	enumeration	10
	enumeration	11
	enumeration	12

simpleType Numero_Rata_Risparmio_Energetico_Type

namespace	urn:www.agenziaentrate.gov.it:specificheTecniche:sco:p73	
type	restriction of DatoNP_Type	
facets	Kind	Value
	pattern	[1-9]{1}[0-9]*
	enumeration	1
	enumeration	2
	enumeration	3
	enumeration	4
	enumeration	5
	enumeration	6
	enumeration	9

simpleType Numero_Rate5o10_Type

namespace	urn:www.agenziaentrate.gov.it:specificheTecniche:sco:p73	
type	restriction of DatoNP_Type	
facets	Kind	Value
	pattern	[1-9]{1}[0-9]*
	enumeration	5
	enumeration	10

simpleType Numero_RateDa1A3_Type

namespace	urn:www.agenziaentrate.gov.it:specificheTecniche:sco:p73	
type	restriction of DatoN1_Type	

facets	Kind	Value
	pattern	[1-9]
	enumeration	1
	enumeration	2
	enumeration	3

simpleType Numero_RateDa1A7_Type

namespace	urn:www.agenziaentrate.gov.it:specificheTecniche:sco:p73	
type	restriction of DatoN1_Type	
facets	Kind	Value
	pattern	[1-9]
	enumeration	1
	enumeration	2
	enumeration	3
	enumeration	4
	enumeration	5
	enumeration	6
enumeration	7	

simpleType Periodo_Spese_Ristrutturazione_Type

namespace	urn:www.agenziaentrate.gov.it:specificheTecniche:sco:p73	
type	restriction of DatoN1_Type	
facets	Kind	Value
	pattern	[1-9]
	enumeration	2
	enumeration	3
	enumeration	4

simpleType Rate10_Type

namespace	urn:www.agenziaentrate.gov.it:specificheTecniche:sco:p73	
type	restriction of DatoNP_Type	
facets	Kind	Value
	pattern	[1-9]{1}[0-9]*
	enumeration	1
	enumeration	2
	enumeration	3
	enumeration	4
	enumeration	5
	enumeration	6
	enumeration	7
	enumeration	8
	enumeration	9
	enumeration	10

simpleType Rate5_Type

namespace	urn:www.agenziaentrate.gov.it:specificheTecniche:sco:p73	
type	restriction of DatoNP_Type	
facets	Kind	Value
	pattern	[1-9]{1}[0-9]*
	enumeration	5

simpleType Rate_Risparmio_Energetico_Type

namespace	urn:www.agenziaentrate.gov.it:specificheTecniche:sco:p73	
type	restriction of DatoNP_Type	
facets	Kind	Value
	pattern	[1-9]{1}[0-9]*
	enumeration	4
	enumeration	5
	enumeration	6
	enumeration	7
	enumeration	8
	enumeration	9
	enumeration	10

simpleType Reintegro_Totale_Parziale_Type

namespace	urn:www.agenziaentrate.gov.it:specificheTecniche:sco:p73	
type	restriction of DatoN1_Type	
facets	Kind	Value
	pattern	[1-9]
	enumeration	1
	enumeration	2

simpleType Rideterminazione_Rate_Type

namespace	urn:www.agenziaentrate.gov.it:specificheTecniche:sco:p73	
type	restriction of DatoNP_Type	
facets	Kind	Value
	pattern	[1-9]{1}[0-9]*
	enumeration	10

simpleType Ripart_Risparmio_Energetico_Type

namespace	urn:www.agenziaentrate.gov.it:specificheTecniche:sco:p73	
type	restriction of DatoNP_Type	
facets	Kind	Value
	pattern	[1-9]{1}[0-9]*
	enumeration	9
	enumeration	10

simpleType Serie_Registrazione_Contratto_Type

namespace	urn:www.agenziaentrate.gov.it:specificheTecniche:sco:p73	
type	restriction of DatoAN_Type	
facets	Kind	Value
	pattern	([0-9A-Z-]"){1}([0-9A-Z&:] ' \" . / ° \"\\(\\ \\) À É Ê Ì Ò Ù Ü " \\\" \\+)*
	enumeration	3
	enumeration	3A
	enumeration	3B
	enumeration	3P
	enumeration	3T

simpleType Terreni_Urbano_Type

namespace	urn:www.agenziaentrate.gov.it:specificheTecniche:sco:p73	
type	restriction of DatoAN_Type	
facets	Kind	Value
	pattern	(([0-9A-Z\-\-]"){1}([0-9A-Z&:] ' \- \., /° \\V\\(\)À É È Ì Ò Ù Û " \\N \\+)*
	enumeration	T
	enumeration	U

simpleType Tipo_Inquilino_Type

namespace	urn:www.agenziaentrate.gov.it:specificheTecniche:sco:p73	
type	restriction of DatoNP_Type	
facets	Kind	Value
	pattern	[1-9]{1}[0-9]*
	enumeration	1
	enumeration	2
	enumeration	3
	enumeration	4

simpleType Tipo_Intervento_Type

namespace	urn:www.agenziaentrate.gov.it:specificheTecniche:sco:p73	
type	restriction of DatoN1_Type	
facets	Kind	Value
	pattern	[1-9]
	enumeration	1
	enumeration	2
	enumeration	3
	enumeration	4
	enumeration	5
	enumeration	6
	enumeration	7

simpleType Tipo_Reddito_Da1a12_Type

namespace	urn:www.agenziaentrate.gov.it:specificheTecniche:sco:p73	
type	restriction of DatoNP_Type	
facets	Kind	Value
	pattern	[1-9]{1}[0-9]*
	enumeration	1
	enumeration	2
	enumeration	3
	enumeration	4
	enumeration	5
	enumeration	6
	enumeration	7
	enumeration	8
	enumeration	9
	enumeration	10
	enumeration	11
	enumeration	12

simpleType Tipo_Reddito_Da1a3_Type

namespace	urn:www.agenziaentrate.gov.it:specificheTecniche:sco:p73	
-----------	--	--

type	restriction of DatoN1_Type										
facets	<table border="1"> <thead> <tr> <th>Kind</th> <th>Value</th> </tr> </thead> <tbody> <tr> <td>pattern</td> <td>[1-9]</td> </tr> <tr> <td>enumeration</td> <td>1</td> </tr> <tr> <td>enumeration</td> <td>2</td> </tr> <tr> <td>enumeration</td> <td>3</td> </tr> </tbody> </table>	Kind	Value	pattern	[1-9]	enumeration	1	enumeration	2	enumeration	3
Kind	Value										
pattern	[1-9]										
enumeration	1										
enumeration	2										
enumeration	3										

simpleType Tipo_Reddito_Da1a4_Type

namespace	urn:www.agenziaentrate.gov.it:specificheTecniche:sco:p73												
type	restriction of DatoN1_Type												
facets	<table border="1"> <thead> <tr> <th>Kind</th> <th>Value</th> </tr> </thead> <tbody> <tr> <td>pattern</td> <td>[1-9]</td> </tr> <tr> <td>enumeration</td> <td>1</td> </tr> <tr> <td>enumeration</td> <td>2</td> </tr> <tr> <td>enumeration</td> <td>3</td> </tr> <tr> <td>enumeration</td> <td>4</td> </tr> </tbody> </table>	Kind	Value	pattern	[1-9]	enumeration	1	enumeration	2	enumeration	3	enumeration	4
Kind	Value												
pattern	[1-9]												
enumeration	1												
enumeration	2												
enumeration	3												
enumeration	4												

simpleType Tipo_Reddito_Da1a6_Type

namespace	urn:www.agenziaentrate.gov.it:specificheTecniche:sco:p73																
type	restriction of DatoN1_Type																
facets	<table border="1"> <thead> <tr> <th>Kind</th> <th>Value</th> </tr> </thead> <tbody> <tr> <td>pattern</td> <td>[1-9]</td> </tr> <tr> <td>enumeration</td> <td>1</td> </tr> <tr> <td>enumeration</td> <td>2</td> </tr> <tr> <td>enumeration</td> <td>3</td> </tr> <tr> <td>enumeration</td> <td>4</td> </tr> <tr> <td>enumeration</td> <td>5</td> </tr> <tr> <td>enumeration</td> <td>6</td> </tr> </tbody> </table>	Kind	Value	pattern	[1-9]	enumeration	1	enumeration	2	enumeration	3	enumeration	4	enumeration	5	enumeration	6
Kind	Value																
pattern	[1-9]																
enumeration	1																
enumeration	2																
enumeration	3																
enumeration	4																
enumeration	5																
enumeration	6																

simpleType Tipo_Reddito_Da1a8_Type

namespace	urn:www.agenziaentrate.gov.it:specificheTecniche:sco:p73																				
type	restriction of DatoNP_Type																				
facets	<table border="1"> <thead> <tr> <th>Kind</th> <th>Value</th> </tr> </thead> <tbody> <tr> <td>pattern</td> <td>[1-9]{1}[0-9]*</td> </tr> <tr> <td>enumeration</td> <td>1</td> </tr> <tr> <td>enumeration</td> <td>2</td> </tr> <tr> <td>enumeration</td> <td>3</td> </tr> <tr> <td>enumeration</td> <td>4</td> </tr> <tr> <td>enumeration</td> <td>5</td> </tr> <tr> <td>enumeration</td> <td>6</td> </tr> <tr> <td>enumeration</td> <td>7</td> </tr> <tr> <td>enumeration</td> <td>8</td> </tr> </tbody> </table>	Kind	Value	pattern	[1-9]{1}[0-9]*	enumeration	1	enumeration	2	enumeration	3	enumeration	4	enumeration	5	enumeration	6	enumeration	7	enumeration	8
Kind	Value																				
pattern	[1-9]{1}[0-9]*																				
enumeration	1																				
enumeration	2																				
enumeration	3																				
enumeration	4																				
enumeration	5																				
enumeration	6																				
enumeration	7																				
enumeration	8																				

simpleType Tipo_Reddito_Da1a9_Type

namespace	urn:www.agenziaentrate.gov.it:specificheTecniche:sco:p73												
type	restriction of DatoNP_Type												
facets	<table border="1"> <thead> <tr> <th>Kind</th> <th>Value</th> </tr> </thead> <tbody> <tr> <td>pattern</td> <td>[1-9]{1}[0-9]*</td> </tr> <tr> <td>enumeration</td> <td>1</td> </tr> <tr> <td>enumeration</td> <td>2</td> </tr> <tr> <td>enumeration</td> <td>3</td> </tr> <tr> <td>enumeration</td> <td>4</td> </tr> </tbody> </table>	Kind	Value	pattern	[1-9]{1}[0-9]*	enumeration	1	enumeration	2	enumeration	3	enumeration	4
Kind	Value												
pattern	[1-9]{1}[0-9]*												
enumeration	1												
enumeration	2												
enumeration	3												
enumeration	4												

	enumeration	5
	enumeration	6
	enumeration	7
	enumeration	8
	enumeration	9

simpleType Titolo_Terreno_Type

namespace	urn:www.agenziaentrate.gov.it:specificheTecniche:sco:p73	
type	restriction of DatoNP_Type	
facets	Kind	Value
	pattern	[1-9]{1}[0-9]*
	enumeration	1
	enumeration	2
	enumeration	3
	enumeration	4
	enumeration	5
	enumeration	6
	enumeration	7
	enumeration	8
	enumeration	9
	enumeration	10

simpleType Utilizzo_Fabbricato_Type

namespace	urn:www.agenziaentrate.gov.it:specificheTecniche:sco:p73	
type	restriction of DatoNP_Type	
facets	Kind	Value
	pattern	[1-9]{1}[0-9]*
	enumeration	1
	enumeration	2
	enumeration	3
	enumeration	4
	enumeration	5
	enumeration	8
	enumeration	9
	enumeration	10
	enumeration	11
	enumeration	12
	enumeration	14
	enumeration	15
	enumeration	16
	enumeration	17

element ElencoFonti

diagram	<pre> classDiagram class ElencoFonti class p73_Fonte["p73:Fonte"] ElencoFonti "1" -- "1..∞" p73_Fonte </pre>
namespace	urn:www.agenziaentrate.gov.it:specificheTecniche:sco:p73
type	p73:ElencoFontiType
children	p73:Fonte

element Sintetico730

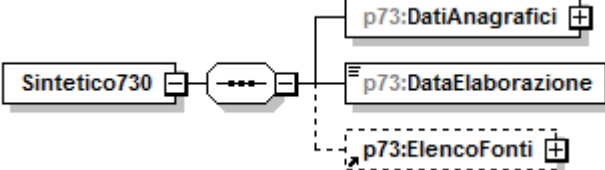
diagram	 <p>The diagram shows the 'Sintetico730' element (rectangle) connected to a sequence container (hexagon with four dots). This container is linked to three child elements: 'p73:DatiAnagrafici' (rectangle with a plus sign), 'p73:DataElaborazione' (rectangle with a list icon), and 'p73:ElencoFonti' (rectangle with a plus sign, shown in a dashed box).</p>
namespace	urn:www.agenziaentrate.gov.it:specificheTecniche:sco:p73
children	p73:DatiAnagrafici p73:DataElaborazione p73:ElencoFonti

element Sintetico730/DatiAnagrafici

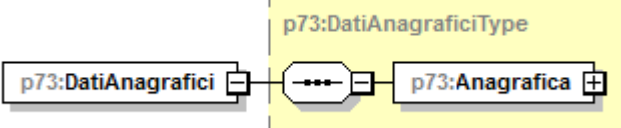
diagram	 <p>The diagram shows the 'p73:DatiAnagrafici' element (rectangle) connected to a sequence container (hexagon with four dots), which is then connected to the 'p73:Anagrafica' element (rectangle with a plus sign). The entire structure is enclosed in a dashed box labeled 'p73:DatiAnagraficiType'.</p>
namespace	urn:www.agenziaentrate.gov.it:specificheTecniche:sco:p73
type	p73:DatiAnagraficiType
children	p73:Anagrafica

element Sintetico730/DataElaborazione

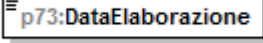
diagram	 <p>The diagram shows the 'p73:DataElaborazione' element (rectangle with a list icon).</p>				
namespace	urn:www.agenziaentrate.gov.it:specificheTecniche:sco:p73				
type	p73:DataType				
facets	<table border="1"> <thead> <tr> <th>Kind</th> <th>Value</th> </tr> </thead> <tbody> <tr> <td>pattern</td> <td>(((0[1-9][12][0-9]3[01])(0[13578]10 12)\d{4})) (((0[1-9][12][0-9]30)(0[469]11)\d{4})) (((0[1-9]1[0-9]2[0-8])(02)\d{4})) (((29)(02)([02468][048]00)) ((29)(02)([13579][26]00)) ((29)(02)([0-9][0-9][0]48)) ((29)(02)([0-9][0-9][2468][048])) ((29)(02)([0-9][0-9][13579][26]))</td> </tr> </tbody> </table>	Kind	Value	pattern	(((0[1-9][12][0-9]3[01])(0[13578]10 12)\d{4})) (((0[1-9][12][0-9]30)(0[469]11)\d{4})) (((0[1-9]1[0-9]2[0-8])(02)\d{4})) (((29)(02)([02468][048]00)) ((29)(02)([13579][26]00)) ((29)(02)([0-9][0-9][0]48)) ((29)(02)([0-9][0-9][2468][048])) ((29)(02)([0-9][0-9][13579][26]))
Kind	Value				
pattern	(((0[1-9][12][0-9]3[01])(0[13578]10 12)\d{4})) (((0[1-9][12][0-9]30)(0[469]11)\d{4})) (((0[1-9]1[0-9]2[0-8])(02)\d{4})) (((29)(02)([02468][048]00)) ((29)(02)([13579][26]00)) ((29)(02)([0-9][0-9][0]48)) ((29)(02)([0-9][0-9][2468][048])) ((29)(02)([0-9][0-9][13579][26]))				

complexType AnagraficaType

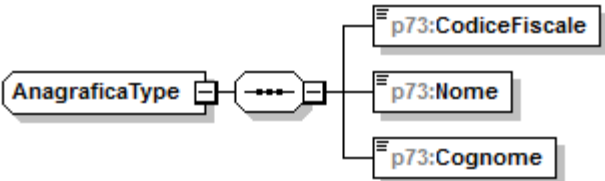
diagram	 <p>The diagram shows the 'AnagraficaType' element (rectangle) connected to a sequence container (hexagon with four dots). This container is linked to three child elements: 'p73:CodiceFiscale' (rectangle with a list icon), 'p73:Nome' (rectangle with a list icon), and 'p73:Cognome' (rectangle with a list icon).</p>
namespace	urn:www.agenziaentrate.gov.it:specificheTecniche:sco:p73
children	p73:CodiceFiscale p73:Nome p73:Cognome

element **AnagraficaType/CodiceFiscale**

diagram	
namespace	urn:www.agenziaentrate.gov.it:specificheTecniche:sco:p73
type	xs:string

element **AnagraficaType/Nome**

diagram	
namespace	urn:www.agenziaentrate.gov.it:specificheTecniche:sco:p73
type	xs:string

element **AnagraficaType/Cognome**

diagram	
namespace	urn:www.agenziaentrate.gov.it:specificheTecniche:sco:p73
type	xs:string

complexType **DatiAnagraficiType**

diagram	
namespace	urn:www.agenziaentrate.gov.it:specificheTecniche:sco:p73
children	p73:Anagrafica

element **DatiAnagraficiType/Anagrafica**

diagram	
namespace	urn:www.agenziaentrate.gov.it:specificheTecniche:sco:p73
type	p73:AnagraficaType
children	p73:CodiceFiscale p73:Nome p73:Cognome

complexType DettaglioFonteType

diagram	
namespace	urn:www.agenziaentrate.gov.it:specificheTecniche:sco:p73
children	p73:Testata p73:TestataImporto p73:TestataUtilizzo p73:Dettaglio

element DettaglioFonteType/Testata

diagram	
namespace	urn:www.agenziaentrate.gov.it:specificheTecniche:sco:p73
type	xs:string

element DettaglioFonteType/TestataImporto

diagram	
namespace	urn:www.agenziaentrate.gov.it:specificheTecniche:sco:p73
type	xs:string

element DettaglioFonteType/TestataUtilizzo

diagram	
namespace	urn:www.agenziaentrate.gov.it:specificheTecniche:sco:p73
type	xs:string

element **DettaglioFonteType/Dettaglio**

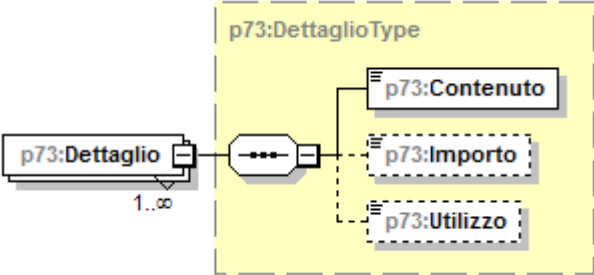
diagram	
namespace	urn:www.agenziaentrate.gov.it:specificheTecniche:sco:p73
type	p73:DettaglioType
children	p73:Contenuto p73:Importo p73:Utilizzo

complexType **DettaglioType**

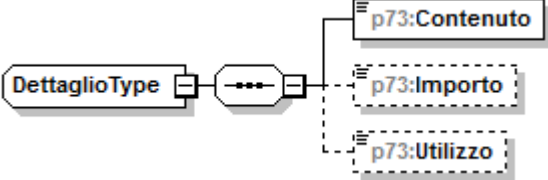
diagram	
namespace	urn:www.agenziaentrate.gov.it:specificheTecniche:sco:p73
children	p73:Contenuto p73:Importo p73:Utilizzo

element **DettaglioType/Contenuto**

diagram	
namespace	urn:www.agenziaentrate.gov.it:specificheTecniche:sco:p73
type	xs:string

element **DettaglioType/Importo**

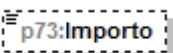
diagram					
namespace	urn:www.agenziaentrate.gov.it:specificheTecniche:sco:p73				
type	p73:ImportoType				
facets	<table border="1"> <thead> <tr> <th>Kind</th> <th>Value</th> </tr> </thead> <tbody> <tr> <td>pattern</td> <td>[0-9]+,[0-9]{1,2}</td> </tr> </tbody> </table>	Kind	Value	pattern	[0-9]+,[0-9]{1,2}
Kind	Value				
pattern	[0-9]+,[0-9]{1,2}				

element **DettaglioType/Utilizzo**

diagram	
namespace	urn:www.agenziaentrate.gov.it:specificheTecniche:sco:p73
type	xs:string

complexType **ElencoFontiType**

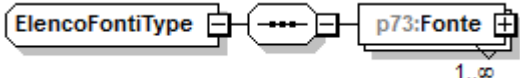
diagram	
namespace	urn:www.agenziaentrate.gov.it:specificheTecniche:sco:p73
children	p73:Fonte

element **ElencoFontiType/Fonte**

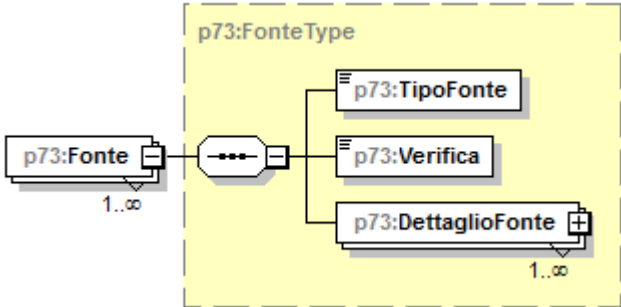
diagram	
namespace	urn:www.agenziaentrate.gov.it:specificheTecniche:sco:p73
type	p73:FonteType
children	p73:TipoFonte p73:Verifica p73:DettaglioFonte

complexType **FonteType**

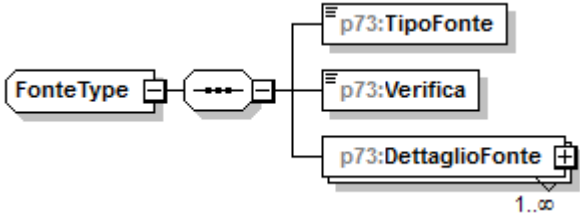
diagram	
namespace	urn:www.agenziaentrate.gov.it:specificheTecniche:sco:p73
children	p73:TipoFonte p73:Verifica p73:DettaglioFonte

element FonteType/TipoFonte

diagram	
namespace	urn:www.agenziaentrate.gov.it:specificheTecniche:sco:p73
type	xs:string

element FonteType/Verifica

diagram	
namespace	urn:www.agenziaentrate.gov.it:specificheTecniche:sco:p73
type	xs:int

element FonteType/DettaglioFonte

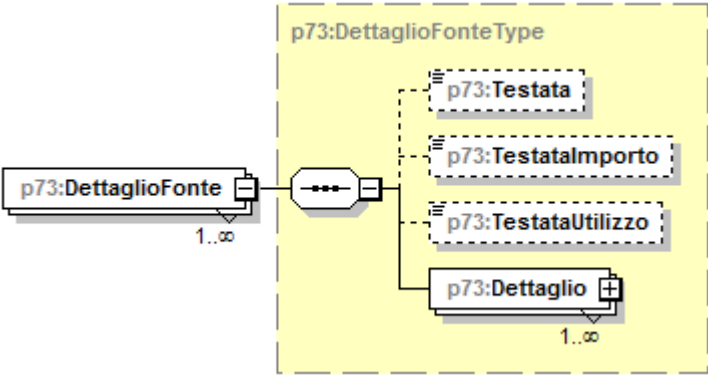
diagram	
namespace	urn:www.agenziaentrate.gov.it:specificheTecniche:sco:p73
type	p73:DettaglioFonteType
children	p73:Testata p73:TestataImporto p73:TestataUtilizzo p73:Dettaglio

simpleType DataType

namespace	urn:www.agenziaentrate.gov.it:specificheTecniche:sco:p73				
type	restriction of xs:string				
facets	<table border="1"> <thead> <tr> <th>Kind</th> <th>Value</th> </tr> </thead> <tbody> <tr> <td>pattern</td> <td>((([0-9][1-9][12][0-9][3][01])(0[13578][10]12)\d{4})) ((([0][1-9][12][0-9][30](0[469][11]\d{4})) ((0[1-9][1][0-9][2][0-8])(02)\d{4})) ((29)(02)([02468][048]00)) ((29)(02)([13579][26]00)) ((29)(02)([0-9][0-9][0][48])) ((29)(02)([0-9][0-9][2468][048])) ((29)(02)([0-9][0-9][13579][26]))))</td> </tr> </tbody> </table>	Kind	Value	pattern	((([0-9][1-9][12][0-9][3][01])(0[13578][10]12)\d{4})) ((([0][1-9][12][0-9][30](0[469][11]\d{4})) ((0[1-9][1][0-9][2][0-8])(02)\d{4})) ((29)(02)([02468][048]00)) ((29)(02)([13579][26]00)) ((29)(02)([0-9][0-9][0][48])) ((29)(02)([0-9][0-9][2468][048])) ((29)(02)([0-9][0-9][13579][26]))))
Kind	Value				
pattern	((([0-9][1-9][12][0-9][3][01])(0[13578][10]12)\d{4})) ((([0][1-9][12][0-9][30](0[469][11]\d{4})) ((0[1-9][1][0-9][2][0-8])(02)\d{4})) ((29)(02)([02468][048]00)) ((29)(02)([13579][26]00)) ((29)(02)([0-9][0-9][0][48])) ((29)(02)([0-9][0-9][2468][048])) ((29)(02)([0-9][0-9][13579][26]))))				

simpleType ImportoType

namespace	urn:www.agenziaentrate.gov.it:specificheTecniche:sco:p73				
type	restriction of xs:string				
facets	<table border="1"> <thead> <tr> <th>Kind</th> <th>Value</th> </tr> </thead> <tbody> <tr> <td>pattern</td> <td>[0-9]+,[0-9]{1,2}</td> </tr> </tbody> </table>	Kind	Value	pattern	[0-9]+,[0-9]{1,2}
Kind	Value				
pattern	[0-9]+,[0-9]{1,2}				

facets	Kind pattern	Value ([0-9])([10-2])([1920][0-9][0-9])
--------	-----------------	--

simpleType DatoDA_Type

namespace	urn:www.agenziaentrate.gov.it:specificheTecniche:common	
type	restriction of xs:string	
facets	Kind pattern	Value (18 19 20)[0-9]{2}

simpleType DatoDN_Type

namespace	urn:www.agenziaentrate.gov.it:specificheTecniche:common	
type	restriction of xs:string	
facets	Kind pattern	Value (((0[1-9][12][0-9]3[01])(0[13578]10 12)\d{4})) (((0[1-9][12][0-9]30)(0[469]11)\d{4})) (((0[1-9]1[0-9]2[0-8])(02)\d{4})) ((29)(02)([02468][048]00)) ((29)(02)([13579][26]00)) ((29)(02)([0-9][0-9][048])) ((29)(02)([0-9][0-9][2468][048])) ((29)(02)([0-9][0-9][13579][26]))

simpleType DatoDT_Type

namespace	urn:www.agenziaentrate.gov.it:specificheTecniche:common	
type	restriction of xs:string	
facets	Kind pattern	Value (((0[1-9][12][0-9]3[01])(0[13578]10 12)\d{4})) (((0[1-9][12][0-9]30)(0[469]11)\d{4})) (((0[1-9]1[0-9]2[0-8])(02)\d{4})) ((29)(02)([02468][048]00)) ((29)(02)([13579][26]00)) ((29)(02)([0-9][0-9][048])) ((29)(02)([0-9][0-9][2468][048])) ((29)(02)([0-9][0-9][13579][26]))

simpleType DatoEM_Type

namespace	urn:www.agenziaentrate.gov.it:specificheTecniche:common	
type	restriction of xs:string	
facets	Kind pattern	Value [a-zA-Z0-9_%\-'"?^~=]+@[a-zA-Z0-9\.-]+\.[a-zA-Z]{2,4}

simpleType DatoGA_Type

namespace	urn:www.agenziaentrate.gov.it:specificheTecniche:common	
type	restriction of xs:string	
facets	Kind pattern	Value [1-9]([1-9][0-9])([12][0-9][0-9])(3[0-5][0-9])(36[0-5])

simpleType DatoN1_Type

namespace	urn:www.agenziaentrate.gov.it:specificheTecniche:common	
type	restriction of xs:string	
facets	Kind pattern	Value [1-9]

simpleType DatoNP_Type

namespace	urn:www.agenziaentrate.gov.it:specificheTecniche:common				
type	restriction of xs:string				
facets	<table border="1"> <tr> <td>Kind</td> <td>Value</td> </tr> <tr> <td>pattern</td> <td>[1-9]{1}[0-9]*</td> </tr> </table>	Kind	Value	pattern	[1-9]{1}[0-9]*
Kind	Value				
pattern	[1-9]{1}[0-9]*				

simpleType DatoNU_Type

namespace	urn:www.agenziaentrate.gov.it:specificheTecniche:common				
type	restriction of xs:string				
facets	<table border="1"> <tr> <td>Kind</td> <td>Value</td> </tr> <tr> <td>pattern</td> <td>(\-[1-9] [1-9])[0-9]*</td> </tr> </table>	Kind	Value	pattern	(\-[1-9] [1-9])[0-9]*
Kind	Value				
pattern	(\-[1-9] [1-9])[0-9]*				

simpleType DatoPC_Type

namespace	urn:www.agenziaentrate.gov.it:specificheTecniche:common				
type	restriction of xs:string				
facets	<table border="1"> <tr> <td>Kind</td> <td>Value</td> </tr> <tr> <td>pattern</td> <td>[0-9]?[0-9](,\d{1,3})? 100,0{1,3}?</td> </tr> </table>	Kind	Value	pattern	[0-9]?[0-9](,\d{1,3})? 100,0{1,3}?
Kind	Value				
pattern	[0-9]?[0-9](,\d{1,3})? 100,0{1,3}?				

simpleType DatoPI_Type

namespace	urn:www.agenziaentrate.gov.it:specificheTecniche:common				
type	restriction of xs:string				
facets	<table border="1"> <tr> <td>Kind</td> <td>Value</td> </tr> <tr> <td>pattern</td> <td>[0-7][0-9]{10}</td> </tr> </table>	Kind	Value	pattern	[0-7][0-9]{10}
Kind	Value				
pattern	[0-7][0-9]{10}				

simpleType DatoQU_Type

namespace	urn:www.agenziaentrate.gov.it:specificheTecniche:common				
type	restriction of xs:string				
facets	<table border="1"> <tr> <td>Kind</td> <td>Value</td> </tr> <tr> <td>pattern</td> <td>[0-9]+,[0-9]{1,5}?</td> </tr> </table>	Kind	Value	pattern	[0-9]+,[0-9]{1,5}?
Kind	Value				
pattern	[0-9]+,[0-9]{1,5}?				

simpleType DatoTL_Type

namespace	urn:www.agenziaentrate.gov.it:specificheTecniche:common				
type	restriction of xs:string				
facets	<table border="1"> <tr> <td>Kind</td> <td>Value</td> </tr> <tr> <td>pattern</td> <td>[0-9]*</td> </tr> </table>	Kind	Value	pattern	[0-9]*
Kind	Value				
pattern	[0-9]*				

simpleType DatoVP_Type

namespace	urn:www.agenziaentrate.gov.it:specificheTecniche:common				
type	restriction of xs:string				
facets	<table border="1"> <tr> <td>Kind</td> <td>Value</td> </tr> <tr> <td>pattern</td> <td>[0-9]+,[0-9]{2}</td> </tr> </table>	Kind	Value	pattern	[0-9]+,[0-9]{2}
Kind	Value				
pattern	[0-9]+,[0-9]{2}				

element Documento

diagram					
namespace	urn:www.agenziaentrate.gov.it:specificheTecniche:common				
type	Documento_Type				
attributes	Name identificativo	Type Identificativo_Type	Use required	Default	Fixed

complexType Documento_Type

diagram					
namespace	urn:www.agenziaentrate.gov.it:specificheTecniche:common				
attributes	Name identificativo	Type Identificativo_Type	Use required	Default	Fixed

attribute Documento_Type/@identificativo

type	Identificativo_Type				
facets	Kind	Value			
	pattern	[0-9]{4}[1-9][0-9]{3}[1-9][0-9][0-9]{2}[1-9][0-9]{2}[0-9][1-9][0-9]{3}[1-9][0-9]{4}			

simpleType Identificativo_Type

namespace	urn:www.agenziaentrate.gov.it:specificheTecniche:common				
type	restriction of xs:string				
facets	Kind	Value			
	pattern	[0-9]{4}[1-9][0-9]{3}[1-9][0-9][0-9]{2}[1-9][0-9]{2}[0-9][1-9][0-9]{3}[1-9][0-9]{4}			

complexType Dati_Anagrafici_Type

diagram	
namespace	urn:www.agenziaentrate.gov.it:specificheTecniche:sco:common
children	Cognome Nome Sesso DataNascita ComuneNascita ProvinciaNascita

element Dati_Anagrafici_Type/Cognome

diagram					
namespace	urn:www.agenziaentrate.gov.it:specificheTecniche:sco:common				
type	DatoAN_Type				
facets	<table border="0"> <tr> <td>Kind</td> <td>Value</td> </tr> <tr> <td>pattern</td> <td>(([0-9A-Z-] &quot;){1}([0-9A-Z&amp;] ' \"- . . /° °\^\\(\\) À È É Ì Ò Ù Û &quot; \\N \\+)*</td> </tr> </table>	Kind	Value	pattern	(([0-9A-Z-] "){1}([0-9A-Z&] ' \"- . . /° °\^\\(\\) À È É Ì Ò Ù Û " \\N \\+)*
Kind	Value				
pattern	(([0-9A-Z-] "){1}([0-9A-Z&] ' \"- . . /° °\^\\(\\) À È É Ì Ò Ù Û " \\N \\+)*				

element Dati_Anagrafici_Type/Nome

diagram					
namespace	urn:www.agenziaentrate.gov.it:specificheTecniche:sco:common				
type	DatoAN_Type				
facets	<table border="0"> <tr> <td>Kind</td> <td>Value</td> </tr> <tr> <td>pattern</td> <td>(([0-9A-Z-] &quot;){1}([0-9A-Z&amp;] ' \"- . . /° °\^\\(\\) À È É Ì Ò Ù Û &quot; \\N \\+)*</td> </tr> </table>	Kind	Value	pattern	(([0-9A-Z-] "){1}([0-9A-Z&] ' \"- . . /° °\^\\(\\) À È É Ì Ò Ù Û " \\N \\+)*
Kind	Value				
pattern	(([0-9A-Z-] "){1}([0-9A-Z&] ' \"- . . /° °\^\\(\\) À È É Ì Ò Ù Û " \\N \\+)*				

element Dati_Anagrafici_Type/Sesso

diagram									
namespace	urn:www.agenziaentrate.gov.it:specificheTecniche:sco:common								
type	Sesso_Type								
facets	<table border="0"> <tr> <td>Kind</td> <td>Value</td> </tr> <tr> <td>pattern</td> <td>(([0-9A-Z-] &quot;){1}([0-9A-Z&amp;] ' \"- . . /° °\^\\(\\) À È É Ì Ò Ù Û &quot; \\N \\+)*</td> </tr> <tr> <td>enumeration</td> <td>M</td> </tr> <tr> <td>enumeration</td> <td>F</td> </tr> </table>	Kind	Value	pattern	(([0-9A-Z-] "){1}([0-9A-Z&] ' \"- . . /° °\^\\(\\) À È É Ì Ò Ù Û " \\N \\+)*	enumeration	M	enumeration	F
Kind	Value								
pattern	(([0-9A-Z-] "){1}([0-9A-Z&] ' \"- . . /° °\^\\(\\) À È É Ì Ò Ù Û " \\N \\+)*								
enumeration	M								
enumeration	F								

element **Dati_Anagrafici_Type/DataNascita**

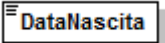
diagram					
namespace	urn:www.agenziaentrate.gov.it:specificheTecniche:sco:common				
type	DatoDT_Type				
facets	<table border="0"> <tr> <td>Kind</td> <td>Value</td> </tr> <tr> <td>pattern</td> <td>((([0-9]{12} [0-9]{3}[01])([0-9]{12} [0-9]{12}(\d{4}))) ((([0-9]{12} [0-9]{30})([0-9]{11} [0-9]{2}[0-8])([0-9]{4}))) ((29)(02)([0-9]{2468}[048]00)) ((29)(02)([1-9]{26}00)) ((29)(02)([0-9]{0-9}[048])) ((29)(02)([0-9]{2468}[048])) ((29)(02)([0-9]{13579}[26]))))</td> </tr> </table>	Kind	Value	pattern	((([0-9]{12} [0-9]{3}[01])([0-9]{12} [0-9]{12}(\d{4}))) ((([0-9]{12} [0-9]{30})([0-9]{11} [0-9]{2}[0-8])([0-9]{4}))) ((29)(02)([0-9]{2468}[048]00)) ((29)(02)([1-9]{26}00)) ((29)(02)([0-9]{0-9}[048])) ((29)(02)([0-9]{2468}[048])) ((29)(02)([0-9]{13579}[26]))))
Kind	Value				
pattern	((([0-9]{12} [0-9]{3}[01])([0-9]{12} [0-9]{12}(\d{4}))) ((([0-9]{12} [0-9]{30})([0-9]{11} [0-9]{2}[0-8])([0-9]{4}))) ((29)(02)([0-9]{2468}[048]00)) ((29)(02)([1-9]{26}00)) ((29)(02)([0-9]{0-9}[048])) ((29)(02)([0-9]{2468}[048])) ((29)(02)([0-9]{13579}[26]))))				

element **Dati_Anagrafici_Type/ComuneNascita**

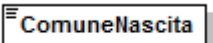
diagram					
namespace	urn:www.agenziaentrate.gov.it:specificheTecniche:sco:common				
type	DatoAN_Type				
facets	<table border="0"> <tr> <td>Kind</td> <td>Value</td> </tr> <tr> <td>pattern</td> <td>([0-9A-Z\-\] \&quot;){1}([0-9A-Z&amp;:] \- \., / \° \^ \(\) \À \É \Ì \Ò \Ù \Û \&quot; \ \+)*</td> </tr> </table>	Kind	Value	pattern	([0-9A-Z\-\] \"){1}([0-9A-Z&:] \- \., / \° \^ \(\) \À \É \Ì \Ò \Ù \Û \" \ \+)*
Kind	Value				
pattern	([0-9A-Z\-\] \"){1}([0-9A-Z&:] \- \., / \° \^ \(\) \À \É \Ì \Ò \Ù \Û \" \ \+)*				

element **Dati_Anagrafici_Type/ProvinciaNascita**

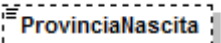
diagram	
namespace	urn:www.agenziaentrate.gov.it:specificheTecniche:sco:common
type	PN_Type

complexType **Dati_Sottoscrittore_Type**

diagram	
namespace	urn:www.agenziaentrate.gov.it:specificheTecniche:sco:common
children	CodiceFiscale CodiceCarica CodiceFiscaleSocieta DatiAnagrafici ResidenzaEstera Telefono DataCarica InizioProcedura ProceduraNonTerminata FineProcedura

element **Dati_Sottoscrittore_Type/CodiceFiscale**

diagram					
namespace	urn:www.agenziaentrate.gov.it:specificheTecniche:sco:common				
type	DatoCF_Type				
facets	<table border="1"> <thead> <tr> <th>Kind</th> <th>Value</th> </tr> </thead> <tbody> <tr> <td>pattern</td> <td>[0-9]{11}[A-Z]{6}[0-9LMNPQRSTUUV]{2}[A-Z]{1}[0-9LMNPQRSTUUV]{2}[A-Z]{1}[0-9LMNPQRSTUUV]{3}[A-Z]{1}</td> </tr> </tbody> </table>	Kind	Value	pattern	[0-9]{11}[A-Z]{6}[0-9LMNPQRSTUUV]{2}[A-Z]{1}[0-9LMNPQRSTUUV]{2}[A-Z]{1}[0-9LMNPQRSTUUV]{3}[A-Z]{1}
Kind	Value				
pattern	[0-9]{11}[A-Z]{6}[0-9LMNPQRSTUUV]{2}[A-Z]{1}[0-9LMNPQRSTUUV]{2}[A-Z]{1}[0-9LMNPQRSTUUV]{3}[A-Z]{1}				

element **Dati_Sottoscrittore_Type/CodiceCarica**

diagram																					
namespace	urn:www.agenziaentrate.gov.it:specificheTecniche:sco:common																				
type	Codice_Carica_Type																				
facets	<table border="1"> <thead> <tr> <th>Kind</th> <th>Value</th> </tr> </thead> <tbody> <tr> <td>pattern</td> <td>[1-9]{1}[0-9]*</td> </tr> <tr> <td>enumeration</td> <td>1</td> </tr> <tr> <td>enumeration</td> <td>2</td> </tr> <tr> <td>enumeration</td> <td>3</td> </tr> <tr> <td>enumeration</td> <td>4</td> </tr> <tr> <td>enumeration</td> <td>5</td> </tr> <tr> <td>enumeration</td> <td>6</td> </tr> <tr> <td>enumeration</td> <td>7</td> </tr> <tr> <td>enumeration</td> <td>8</td> </tr> </tbody> </table>	Kind	Value	pattern	[1-9]{1}[0-9]*	enumeration	1	enumeration	2	enumeration	3	enumeration	4	enumeration	5	enumeration	6	enumeration	7	enumeration	8
Kind	Value																				
pattern	[1-9]{1}[0-9]*																				
enumeration	1																				
enumeration	2																				
enumeration	3																				
enumeration	4																				
enumeration	5																				
enumeration	6																				
enumeration	7																				
enumeration	8																				

	enumeration	9
	enumeration	10
	enumeration	11
	enumeration	12
	enumeration	13
	enumeration	14
	enumeration	15

element Dati_Sottoscrittore_Type/CodiceFiscaleSocieta

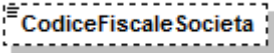
diagram	
namespace	urn:www.agenziaentrate.gov.it:specificheTecniche:sco:common
type	DatoCN Type
facets	Kind Value pattern [0-9]{11}

element Dati_Sottoscrittore_Type/DatiAnagrafici

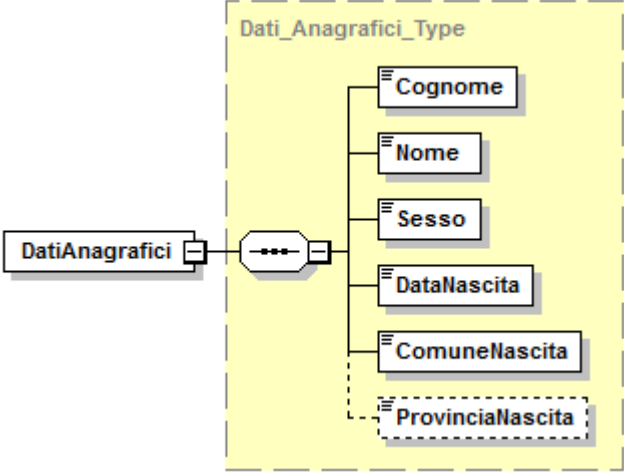
diagram	
namespace	urn:www.agenziaentrate.gov.it:specificheTecniche:sco:common
type	Dati_Anagrafici Type
children	Cognome Nome Sesso DataNascita ComuneNascita ProvinciaNascita

element **Dati_Sottoscrittore_Type/ResidenzaEstera**

diagram	
namespace	urn:www.agenziaentrate.gov.it:specificheTecniche:sco:common
type	Residenza_Estera_Type
children	CodiceStatoEstero StatoFederato LocalitaEstero IndirizzoEstero

element **Dati_Sottoscrittore_Type/Telefono**

diagram					
namespace	urn:www.agenziaentrate.gov.it:specificheTecniche:sco:common				
type	DatoTL_Type				
facets	<table border="1"> <thead> <tr> <th>Kind</th> <th>Value</th> </tr> </thead> <tbody> <tr> <td>pattern</td> <td>[0-9]*</td> </tr> </tbody> </table>	Kind	Value	pattern	[0-9]*
Kind	Value				
pattern	[0-9]*				

element **Dati_Sottoscrittore_Type/DataCarica**

diagram					
namespace	urn:www.agenziaentrate.gov.it:specificheTecniche:sco:common				
type	DatoDT_Type				
facets	<table border="1"> <thead> <tr> <th>Kind</th> <th>Value</th> </tr> </thead> <tbody> <tr> <td>pattern</td> <td>((([0-9]{1,12}[0-9]{3,01})(0[13578][10]12\d{4})) ((([0-9]{1,12}[0-9]{30})(0[469][11]\d{4})) ((([0-9]{1,12}[0-9]{2,0-8})(02\d{4})) ((29)(02)[02468][048]00)) ((29)(02)[13579][26]00)) ((29)(02)[0-9][0-9][0148])) ((29)(02)[0-9][0-9][2468][048])) ((29)(02)[0-9][0-9][13579][26]))</td> </tr> </tbody> </table>	Kind	Value	pattern	((([0-9]{1,12}[0-9]{3,01})(0[13578][10]12\d{4})) ((([0-9]{1,12}[0-9]{30})(0[469][11]\d{4})) ((([0-9]{1,12}[0-9]{2,0-8})(02\d{4})) ((29)(02)[02468][048]00)) ((29)(02)[13579][26]00)) ((29)(02)[0-9][0-9][0148])) ((29)(02)[0-9][0-9][2468][048])) ((29)(02)[0-9][0-9][13579][26]))
Kind	Value				
pattern	((([0-9]{1,12}[0-9]{3,01})(0[13578][10]12\d{4})) ((([0-9]{1,12}[0-9]{30})(0[469][11]\d{4})) ((([0-9]{1,12}[0-9]{2,0-8})(02\d{4})) ((29)(02)[02468][048]00)) ((29)(02)[13579][26]00)) ((29)(02)[0-9][0-9][0148])) ((29)(02)[0-9][0-9][2468][048])) ((29)(02)[0-9][0-9][13579][26]))				

element **Dati_Sottoscrittore_Type/InizioProcedura**

diagram					
namespace	urn:www.agenziaentrate.gov.it:specificheTecniche:sco:common				
type	DatoDT_Type				
facets	<table border="1"> <thead> <tr> <th>Kind</th> <th>Value</th> </tr> </thead> <tbody> <tr> <td>pattern</td> <td>((([0-9]{1,12}[0-9]{3,01})(0[13578][10]12\d{4})) ((([0-9]{1,12}[0-9]{30})(0[469][11]\d{4})) ((([0-9]{1,12}[0-9]{2,0-8})(02\d{4})) ((29)(02)[02468][048]00)) ((29)(02)[13579][26]00)) ((29)(02)[0-9][0-9][0148])) ((29)(02)[0-9][0-9][2468][048])) ((29)(02)[0-9][0-9][13579][26]))</td> </tr> </tbody> </table>	Kind	Value	pattern	((([0-9]{1,12}[0-9]{3,01})(0[13578][10]12\d{4})) ((([0-9]{1,12}[0-9]{30})(0[469][11]\d{4})) ((([0-9]{1,12}[0-9]{2,0-8})(02\d{4})) ((29)(02)[02468][048]00)) ((29)(02)[13579][26]00)) ((29)(02)[0-9][0-9][0148])) ((29)(02)[0-9][0-9][2468][048])) ((29)(02)[0-9][0-9][13579][26]))
Kind	Value				
pattern	((([0-9]{1,12}[0-9]{3,01})(0[13578][10]12\d{4})) ((([0-9]{1,12}[0-9]{30})(0[469][11]\d{4})) ((([0-9]{1,12}[0-9]{2,0-8})(02\d{4})) ((29)(02)[02468][048]00)) ((29)(02)[13579][26]00)) ((29)(02)[0-9][0-9][0148])) ((29)(02)[0-9][0-9][2468][048])) ((29)(02)[0-9][0-9][13579][26]))				

element Domicilio_EE_Type/Provincia

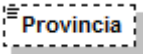
diagram	
namespace	urn:www.agenziaentrate.gov.it:specificheTecniche:sco:common
type	PE_Type

element Domicilio_EE_Type/CodiceComune

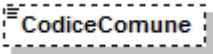
diagram					
namespace	urn:www.agenziaentrate.gov.it:specificheTecniche:sco:common				
type	DatoAN_Type				
facets	<table border="0"> <tr> <td>Kind</td> <td>Value</td> </tr> <tr> <td>pattern</td> <td>([0-9A-Z-]*)&quot;}{1}([0-9A-Z&amp;#226;:] ' \"- \". , / ^ ^\\"(\\) À É Ê Ë Ì Ò Ù Û &quot; \\\" \\+)*</td> </tr> </table>	Kind	Value	pattern	([0-9A-Z-]*)"}{1}([0-9A-Z&#226;:] ' \"- \". , / ^ ^\\"(\\) À É Ê Ë Ì Ò Ù Û " \\\" \\+)*
Kind	Value				
pattern	([0-9A-Z-]*)"}{1}([0-9A-Z&#226;:] ' \"- \". , / ^ ^\\"(\\) À É Ê Ë Ì Ò Ù Û " \\\" \\+)*				

element Domicilio_EE_Type/Indirizzo

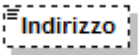
diagram					
namespace	urn:www.agenziaentrate.gov.it:specificheTecniche:sco:common				
type	DatoAN_Type				
facets	<table border="0"> <tr> <td>Kind</td> <td>Value</td> </tr> <tr> <td>pattern</td> <td>([0-9A-Z-]*)&quot;}{1}([0-9A-Z&amp;#226;:] ' \"- \". , / ^ ^\\"(\\) À É Ê Ë Ì Ò Ù Û &quot; \\\" \\+)*</td> </tr> </table>	Kind	Value	pattern	([0-9A-Z-]*)"}{1}([0-9A-Z&#226;:] ' \"- \". , / ^ ^\\"(\\) À É Ê Ë Ì Ò Ù Û " \\\" \\+)*
Kind	Value				
pattern	([0-9A-Z-]*)"}{1}([0-9A-Z&#226;:] ' \"- \". , / ^ ^\\"(\\) À É Ê Ë Ì Ò Ù Û " \\\" \\+)*				

element Domicilio_EE_Type/Cap

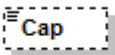
diagram					
namespace	urn:www.agenziaentrate.gov.it:specificheTecniche:sco:common				
type	DatoCP_Type				
facets	<table border="0"> <tr> <td>Kind</td> <td>Value</td> </tr> <tr> <td>pattern</td> <td>[0-9]{5}</td> </tr> </table>	Kind	Value	pattern	[0-9]{5}
Kind	Value				
pattern	[0-9]{5}				

element Domicilio_EE_Type/DataVariazione

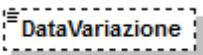
diagram					
namespace	urn:www.agenziaentrate.gov.it:specificheTecniche:sco:common				
type	DatoD6_Type				
facets	<table border="0"> <tr> <td>Kind</td> <td>Value</td> </tr> <tr> <td>pattern</td> <td>((0[0-9]) (1[0-2]))((19 20)[0-9][0-9])</td> </tr> </table>	Kind	Value	pattern	((0[0-9]) (1[0-2]))((19 20)[0-9][0-9])
Kind	Value				
pattern	((0[0-9]) (1[0-2]))((19 20)[0-9][0-9])				

complexType **Domicilio_Fiscale_Type**

diagram	
namespace	urn:www.agenziaentrate.gov.it:specificheTecniche:sco:common
type	extension of Domicilio_Ita_Type
children	Comune Provincia CodiceComune Indirizzo Cap DataVariazione

element **Domicilio_Fiscale_Type/DataVariazione**

diagram					
namespace	urn:www.agenziaentrate.gov.it:specificheTecniche:sco:common				
type	DatoD6_Type				
facets	<table border="0"> <tr> <td>Kind</td> <td>Value</td> </tr> <tr> <td>pattern</td> <td>((0[0-9]) (1[0-2]))((19 20)[0-9][0-9])</td> </tr> </table>	Kind	Value	pattern	((0[0-9]) (1[0-2]))((19 20)[0-9][0-9])
Kind	Value				
pattern	((0[0-9]) (1[0-2]))((19 20)[0-9][0-9])				

complexType **Domicilio_Ita_Type**

diagram	
namespace	urn:www.agenziaentrate.gov.it:specificheTecniche:sco:common
children	Comune Provincia CodiceComune Indirizzo Cap

element Domicilio_Ita_Type/Comune

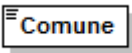
diagram	
namespace	urn:www.agenziaentrate.gov.it:specificheTecniche:sco:common
type	DatoAN_Type
facets	Kind Value pattern ([0-9A-Z\-\"]{1}([0-9A-Z&#39; \-\ \. / \^\(\ \)\À É Ê Ë Ì Ò Ù Ü " \ \ /+)*

element Domicilio_Ita_Type/Provincia

diagram	
namespace	urn:www.agenziaentrate.gov.it:specificheTecniche:sco:common
type	PR_Type

element Domicilio_Ita_Type/CodiceComune

diagram	
namespace	urn:www.agenziaentrate.gov.it:specificheTecniche:sco:common
type	DatoAN_Type
facets	Kind Value pattern ([0-9A-Z\-\"]{1}([0-9A-Z&#39; \-\ \. / \^\(\ \)\À É Ê Ë Ì Ò Ù Ü " \ \ /+)*

element Domicilio_Ita_Type/Indirizzo

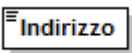
diagram	
namespace	urn:www.agenziaentrate.gov.it:specificheTecniche:sco:common
type	DatoAN_Type
facets	Kind Value pattern ([0-9A-Z\-\"]{1}([0-9A-Z&#39; \-\ \. / \^\(\ \)\À É Ê Ë Ì Ò Ù Ü " \ \ /+)*

element Domicilio_Ita_Type/Cap

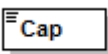
diagram	
namespace	urn:www.agenziaentrate.gov.it:specificheTecniche:sco:common
type	DatoCP_Type
facets	Kind Value pattern [0-9]{5}

complexType Firma_Revisione_Type

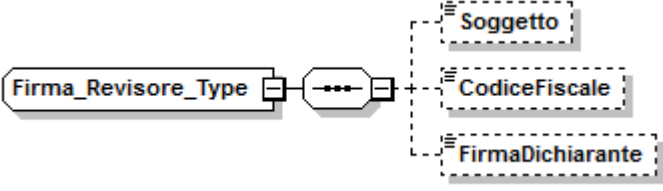
diagram	
namespace	urn:www.agenziaentrate.gov.it:specificheTecniche:sco:common
children	Soggetto CodiceFiscale FirmaDichiarante

element Firma_Revisione_Type/Soggetto

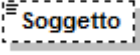
diagram	
namespace	urn:www.agenziaentrate.gov.it:specificheTecniche:sco:common
type	restriction of DatoNP_Type
facets	Kind Value pattern [1-4]

element Firma_Revisione_Type/CodiceFiscale

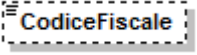
diagram	
namespace	urn:www.agenziaentrate.gov.it:specificheTecniche:sco:common
type	DatoCF_Type
facets	Kind Value pattern [0-9]{11}[A-Z]{6}[0-9LMNPQRSTU]{2}[A-Z]{1}[0-9LMNPQRSTU]{2}[A-Z]{1}[0-9LMNPQRSTU]{3}[A-Z]{1}

element Firma_Revisione_Type/FirmaDichiarante

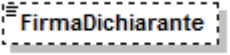
diagram	
namespace	urn:www.agenziaentrate.gov.it:specificheTecniche:sco:common
type	DatoCB_Type
facets	Kind Value pattern [01]

complexType Firma_Type

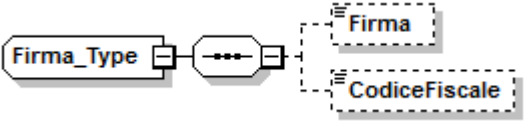
diagram	
namespace	urn:www.agenziaentrate.gov.it:specificheTecniche:sco:common

children	Firma CodiceFiscale
----------	-------------------------------------

element Firma_Type/Firma

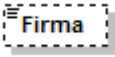
diagram	
namespace	urn:www.agenziaentrate.gov.it:specificheTecniche:sco:common
type	DatoCB_Type
facets	Kind Value pattern [01]

element Firma_Type/CodiceFiscale

diagram	
namespace	urn:www.agenziaentrate.gov.it:specificheTecniche:sco:common
type	restriction of xs:string
facets	Kind Value pattern (([0-9A-Z-] \"){0,1})([0-9A-Z&#x26;#x27; \- \., _ s / ^\\(\\) À È É Ì Ò Ù Û " \N / +)*

complexType Frontespizio_Type

diagram	
namespace	urn:www.agenziaentrate.gov.it:specificheTecniche:sco:common
children	SoggettoFiscale

element Frontespizio_Type/SoggettoFiscale

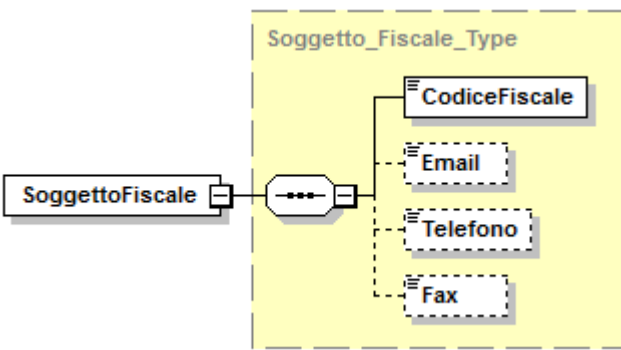
diagram	
namespace	urn:www.agenziaentrate.gov.it:specificheTecniche:sco:common
type	Soggetto Fiscale_Type
children	CodiceFiscale Email Telefono Fax

complexType **Impegno_A_Trasmettere_Type**

diagram	
namespace	urn:www.agenziaentrate.gov.it:specificheTecniche:sco:common
children	CFintermediario NumerolscrAlboCAF ImpegnoATrasmettere RicezioneAvvisoTelem DataImpegno FirmaIntermediario

element **Impegno_A_Trasmettere_Type/CFintermediario**

diagram					
namespace	urn:www.agenziaentrate.gov.it:specificheTecniche:sco:common				
type	DatoCF_Type				
facets	<table border="1"> <tr> <th>Kind</th> <th>Value</th> </tr> <tr> <td>pattern</td> <td>[0-9]{11}[A-Z]{6}[0-9LMNPQRSTUW]{2}[A-Z]{1}[0-9LMNPQRSTUW]{2}[A-Z]{1}[0-9LMNPQRSTUW]{3}[A-Z]{1}</td> </tr> </table>	Kind	Value	pattern	[0-9]{11}[A-Z]{6}[0-9LMNPQRSTUW]{2}[A-Z]{1}[0-9LMNPQRSTUW]{2}[A-Z]{1}[0-9LMNPQRSTUW]{3}[A-Z]{1}
Kind	Value				
pattern	[0-9]{11}[A-Z]{6}[0-9LMNPQRSTUW]{2}[A-Z]{1}[0-9LMNPQRSTUW]{2}[A-Z]{1}[0-9LMNPQRSTUW]{3}[A-Z]{1}				

element **Impegno_A_Trasmettere_Type/NumerolscrAlboCAF**

diagram					
namespace	urn:www.agenziaentrate.gov.it:specificheTecniche:sco:common				
type	restriction of DatoNU_Type				
facets	<table border="1"> <tr> <th>Kind</th> <th>Value</th> </tr> <tr> <td>pattern</td> <td>(\[1-9][1-9])[0-9]*</td> </tr> </table>	Kind	Value	pattern	(\[1-9][1-9])[0-9]*
Kind	Value				
pattern	(\[1-9][1-9])[0-9]*				

element **Impegno_A_Trasmettere_Type/ImpegnoATrasmettere**

diagram									
namespace	urn:www.agenziaentrate.gov.it:specificheTecniche:sco:common								
type	restriction of DatoNP_Type								
facets	<table border="1"> <tr> <th>Kind</th> <th>Value</th> </tr> <tr> <td>pattern</td> <td>1 2</td> </tr> <tr> <td>enumeration</td> <td>1</td> </tr> <tr> <td>enumeration</td> <td>2</td> </tr> </table>	Kind	Value	pattern	1 2	enumeration	1	enumeration	2
Kind	Value								
pattern	1 2								
enumeration	1								
enumeration	2								

element **Impegno_A_Trasmettere_Type/RicezioneAvvisoTelem**

diagram	
namespace	urn:www.agenziaentrate.gov.it:specificheTecniche:sco:common
type	DatoCB_Type
facets	Kind Value pattern [01]

element **Impegno_A_Trasmettere_Type/DatalImpegno**

diagram	
namespace	urn:www.agenziaentrate.gov.it:specificheTecniche:sco:common
type	DatoDT_Type
facets	Kind Value pattern (((([0-9][12][0-9][3][01])([0-9][13578][10][12](\d{4}))) ((([0-9][1-9][12][0-9][30)([0-9][469][11](\d{4}))) ((([0-9][1-9][1][0-9][2][0-8])([0-9][2](\d{4}))) ((([29][02][02468][048][00]) ((([29][02][13579][26][00]) ((([29][02][0-9][0-9][0][48]) ((([29][02][0-9][0-9][2468][048]) ((([29][02][0-9][0-9][13579][26])))))

element **Impegno_A_Trasmettere_Type/FirmaIntermediario**

diagram	
namespace	urn:www.agenziaentrate.gov.it:specificheTecniche:sco:common
type	DatoCB_Type
facets	Kind Value pattern [01]

complexType **Persone_Fisiche_Type**

diagram	
namespace	urn:www.agenziaentrate.gov.it:specificheTecniche:sco:common
children	DatiAnagrafici ResidenzaAnagrafica

element **Persone_Fisiche_Type/DatiAnagrafici**

<p>diagram</p>	
<p>namespace</p>	<p>urn:www.agenziaentrate.gov.it:specificheTecniche:sco:common</p>
<p>type</p>	<p>Dati_Anagrafici_Type</p>
<p>children</p>	<p>Cognome Nome Sesso DataNascita ComuneNascita ProvinciaNascita</p>

element **Persone_Fisiche_Type/ResidenzaAnagrafica**

<p>diagram</p>	
<p>namespace</p>	<p>urn:www.agenziaentrate.gov.it:specificheTecniche:sco:common</p>
<p>type</p>	<p>Residenza_Anagrafica_Type</p>
<p>children</p>	<p>Comune Provincia CodiceComune Indirizzo Cap DataVariazione</p>

complexType **Residenza_Anagrafica_Type**

diagram	
namespace	urn:www.agenziaentrate.gov.it:specificheTecniche:sco:common
type	extension of Domicilio_Ita_Type
children	Comune Provincia CodiceComune Indirizzo Cap DataVariazione

element **Residenza_Anagrafica_Type/DataVariazione**

diagram					
namespace	urn:www.agenziaentrate.gov.it:specificheTecniche:sco:common				
type	DatoDT_Type				
facets	<table border="1"> <thead> <tr> <th>Kind</th> <th>Value</th> </tr> </thead> <tbody> <tr> <td>pattern</td> <td>((([0-9]{1,2} [0-9]{3} 01))([0-9]{1,2} 10 12)\d{4}) ((([0-9]{1,2} [0-9]{3} 01 30)([0-9]{1,2} 11)\d{4}) ((([0-9]{1,2} [0-9]{3} 0-8) 02)\d{4}) ((29)(02)([0-9]{2} 048 00)) ((29)(02)([0-9]{2} 26 00)) ((29)(02)([0-9]{2} 048)) ((29)(02)([0-9]{2} 2468 048)) ((29)(02)([0-9]{2} 13579 26))))</td> </tr> </tbody> </table>	Kind	Value	pattern	((([0-9]{1,2} [0-9]{3} 01))([0-9]{1,2} 10 12)\d{4}) ((([0-9]{1,2} [0-9]{3} 01 30)([0-9]{1,2} 11)\d{4}) ((([0-9]{1,2} [0-9]{3} 0-8) 02)\d{4}) ((29)(02)([0-9]{2} 048 00)) ((29)(02)([0-9]{2} 26 00)) ((29)(02)([0-9]{2} 048)) ((29)(02)([0-9]{2} 2468 048)) ((29)(02)([0-9]{2} 13579 26))))
Kind	Value				
pattern	((([0-9]{1,2} [0-9]{3} 01))([0-9]{1,2} 10 12)\d{4}) ((([0-9]{1,2} [0-9]{3} 01 30)([0-9]{1,2} 11)\d{4}) ((([0-9]{1,2} [0-9]{3} 0-8) 02)\d{4}) ((29)(02)([0-9]{2} 048 00)) ((29)(02)([0-9]{2} 26 00)) ((29)(02)([0-9]{2} 048)) ((29)(02)([0-9]{2} 2468 048)) ((29)(02)([0-9]{2} 13579 26))))				

complexType **Residenza_Estera_Type**

diagram	
namespace	urn:www.agenziaentrate.gov.it:specificheTecniche:sco:common
children	CodiceStatoEstero StatoFederato LocalitaEstero IndirizzoEstero

element **Residenza_Estera_Type/CodiceStatoEstero**

diagram	
namespace	urn:www.agenziaentrate.gov.it:specificheTecniche:sco:common
type	restriction of DatoAN_Type
facets	Kind Value pattern ([0-9A-Z\-\] \"){1}([0-9A-Z&] '\- \., /'°\^\(\)\)À É Ê Ì Ò Ù Ü ";\ \ \ /+)*

element **Residenza_Estera_Type/StatoFederato**

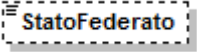
diagram	
namespace	urn:www.agenziaentrate.gov.it:specificheTecniche:sco:common
type	restriction of DatoAN_Type
facets	Kind Value pattern ([0-9A-Z\-\] \"){1}([0-9A-Z&] '\- \., /'°\^\(\)\)À É Ê Ì Ò Ù Ü ";\ \ \ /+)*

element **Residenza_Estera_Type/LocalitaEstero**

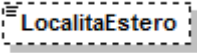
diagram	
namespace	urn:www.agenziaentrate.gov.it:specificheTecniche:sco:common
type	DatoAN_Type
facets	Kind Value pattern ([0-9A-Z\-\] \"){1}([0-9A-Z&] '\- \., /'°\^\(\)\)À É Ê Ì Ò Ù Ü ";\ \ \ /+)*

element **Residenza_Estera_Type/IndirizzoEstero**

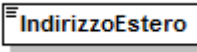
diagram	
namespace	urn:www.agenziaentrate.gov.it:specificheTecniche:sco:common
type	DatoAN_Type
facets	Kind Value pattern ([0-9A-Z\-\] \"){1}([0-9A-Z&] '\- \., /'°\^\(\)\)À É Ê Ì Ò Ù Ü ";\ \ \ /+)*

complexType **Soggetti_Diversi_Da_PF_Type**

<p>diagram</p>	
<p>namespace</p>	<p>urn:www.agenziaentrate.gov.it:specificheTecniche:sco:common</p>
<p>children</p>	<p>Denominazione SedeLegale DomicilioFiscale DataApprovazioneBilancio TermineApprovazioneBilancio InizioPeriodoImposta FinePeriodoImposta Stato NaturaGiuridica Situazione</p>

element **Soggetti_Diversi_Da_PF_Type/Denominazione**

<p>diagram</p>	
<p>namespace</p>	<p>urn:www.agenziaentrate.gov.it:specificheTecniche:sco:common</p>
<p>type</p>	<p>DatoAN_Type</p>
<p>facets</p>	<p>Kind Value pattern <code>(([0-9A-Z-] \&quot;){1}([0-9A-Z&amp;#39; ! @ _ ` \.\, / ° ' \(\) \) À É È Ì Ò Ù Û &quot; \ \\ / +)*</code></p>

element **Soggetti_Diversi_Da_PF_Type/SedeLegale**

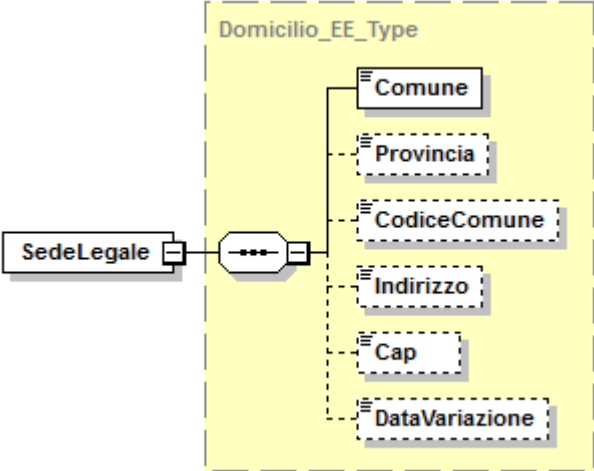
<p>diagram</p>	 <p>The diagram illustrates the structure of the SedeLegale element. It is connected to a container labeled Domicilio_EE_Type. Inside this container, there are six fields: Comune, Provincia, CodiceComune, Indirizzo, Cap, and DataVariazione. The Comune field is shown as a solid box, while the others are dashed boxes. The SedeLegale element is connected to the container via a line with a small square and a circle containing three dots.</p>
<p>namespace</p>	<p>urn:www.agenziaentrate.gov.it:specificheTecniche:sco:common</p>
<p>type</p>	<p>Domicilio_EE_Type</p>
<p>children</p>	<p>Comune Provincia CodiceComune Indirizzo Cap DataVariazione</p>

element **Soggetti_Diversi_Da_PF_Type/DomicilioFiscale**

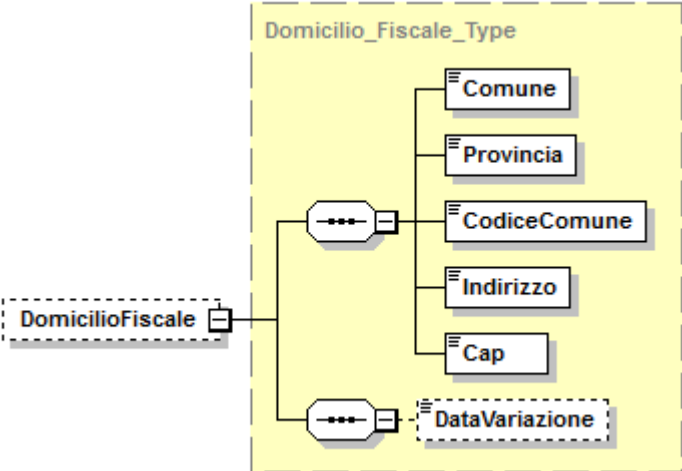
<p>diagram</p>	 <p>The diagram illustrates the structure of the DomicilioFiscale element. It is connected to a container labeled Domicilio_Fiscale_Type. Inside this container, there are six fields: Comune, Provincia, CodiceComune, Indirizzo, Cap, and DataVariazione. The Comune, Provincia, Indirizzo, and Cap fields are shown as solid boxes, while CodiceComune and DataVariazione are dashed boxes. The DomicilioFiscale element is connected to the container via a line with a small square and a circle containing three dots.</p>
<p>namespace</p>	<p>urn:www.agenziaentrate.gov.it:specificheTecniche:sco:common</p>
<p>type</p>	<p>Domicilio_Fiscale_Type</p>
<p>children</p>	<p>Comune Provincia CodiceComune Indirizzo Cap DataVariazione</p>

element **Soggetti_Diversi_Da_PF_Type/DataApprovazioneBilancio**

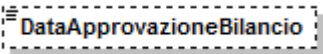
<p>diagram</p>	 <p>The diagram shows a single dashed box representing the DataApprovazioneBilancio element.</p>
<p>namespace</p>	<p>urn:www.agenziaentrate.gov.it:specificheTecniche:sco:common</p>

type	DatoDT_Type				
facets	<table border="1"> <tr> <td>Kind</td> <td>Value</td> </tr> <tr> <td>pattern</td> <td>(((0[1-9][12][0-9]3[01])(0[13578]10 12)\d{4})) ((0[1-9][12][0-9]30)(0[469]11)\d{4})) ((0[1-9]1[0-9]2[0-8])(02)\d{4})) ((29)(02)([02468][048]00)) ((29)(02)([13579][26]00)) ((29)(02)([0-9][0-9][0][48])) ((29)(02)([0-9][0-9][2468][048])) ((29)(02)([0-9][0-9][13579][26]))</td> </tr> </table>	Kind	Value	pattern	(((0[1-9][12][0-9]3[01])(0[13578]10 12)\d{4})) ((0[1-9][12][0-9]30)(0[469]11)\d{4})) ((0[1-9]1[0-9]2[0-8])(02)\d{4})) ((29)(02)([02468][048]00)) ((29)(02)([13579][26]00)) ((29)(02)([0-9][0-9][0][48])) ((29)(02)([0-9][0-9][2468][048])) ((29)(02)([0-9][0-9][13579][26]))
Kind	Value				
pattern	(((0[1-9][12][0-9]3[01])(0[13578]10 12)\d{4})) ((0[1-9][12][0-9]30)(0[469]11)\d{4})) ((0[1-9]1[0-9]2[0-8])(02)\d{4})) ((29)(02)([02468][048]00)) ((29)(02)([13579][26]00)) ((29)(02)([0-9][0-9][0][48])) ((29)(02)([0-9][0-9][2468][048])) ((29)(02)([0-9][0-9][13579][26]))				

element **Soggetti_Diversi_Da_PF_Type/TermineApprovazioneBilancio**

diagram					
namespace	urn:www.agenziaentrate.gov.it:specificheTecniche:sco:common				
type	DatoDT_Type				
facets	<table border="1"> <tr> <td>Kind</td> <td>Value</td> </tr> <tr> <td>pattern</td> <td>(((0[1-9][12][0-9]3[01])(0[13578]10 12)\d{4})) ((0[1-9][12][0-9]30)(0[469]11)\d{4})) ((0[1-9]1[0-9]2[0-8])(02)\d{4})) ((29)(02)([02468][048]00)) ((29)(02)([13579][26]00)) ((29)(02)([0-9][0-9][0][48])) ((29)(02)([0-9][0-9][2468][048])) ((29)(02)([0-9][0-9][13579][26]))</td> </tr> </table>	Kind	Value	pattern	(((0[1-9][12][0-9]3[01])(0[13578]10 12)\d{4})) ((0[1-9][12][0-9]30)(0[469]11)\d{4})) ((0[1-9]1[0-9]2[0-8])(02)\d{4})) ((29)(02)([02468][048]00)) ((29)(02)([13579][26]00)) ((29)(02)([0-9][0-9][0][48])) ((29)(02)([0-9][0-9][2468][048])) ((29)(02)([0-9][0-9][13579][26]))
Kind	Value				
pattern	(((0[1-9][12][0-9]3[01])(0[13578]10 12)\d{4})) ((0[1-9][12][0-9]30)(0[469]11)\d{4})) ((0[1-9]1[0-9]2[0-8])(02)\d{4})) ((29)(02)([02468][048]00)) ((29)(02)([13579][26]00)) ((29)(02)([0-9][0-9][0][48])) ((29)(02)([0-9][0-9][2468][048])) ((29)(02)([0-9][0-9][13579][26]))				

element **Soggetti_Diversi_Da_PF_Type/InizioPeriodoImposta**

diagram					
namespace	urn:www.agenziaentrate.gov.it:specificheTecniche:sco:common				
type	DatoDT_Type				
facets	<table border="1"> <tr> <td>Kind</td> <td>Value</td> </tr> <tr> <td>pattern</td> <td>(((0[1-9][12][0-9]3[01])(0[13578]10 12)\d{4})) ((0[1-9][12][0-9]30)(0[469]11)\d{4})) ((0[1-9]1[0-9]2[0-8])(02)\d{4})) ((29)(02)([02468][048]00)) ((29)(02)([13579][26]00)) ((29)(02)([0-9][0-9][0][48])) ((29)(02)([0-9][0-9][2468][048])) ((29)(02)([0-9][0-9][13579][26]))</td> </tr> </table>	Kind	Value	pattern	(((0[1-9][12][0-9]3[01])(0[13578]10 12)\d{4})) ((0[1-9][12][0-9]30)(0[469]11)\d{4})) ((0[1-9]1[0-9]2[0-8])(02)\d{4})) ((29)(02)([02468][048]00)) ((29)(02)([13579][26]00)) ((29)(02)([0-9][0-9][0][48])) ((29)(02)([0-9][0-9][2468][048])) ((29)(02)([0-9][0-9][13579][26]))
Kind	Value				
pattern	(((0[1-9][12][0-9]3[01])(0[13578]10 12)\d{4})) ((0[1-9][12][0-9]30)(0[469]11)\d{4})) ((0[1-9]1[0-9]2[0-8])(02)\d{4})) ((29)(02)([02468][048]00)) ((29)(02)([13579][26]00)) ((29)(02)([0-9][0-9][0][48])) ((29)(02)([0-9][0-9][2468][048])) ((29)(02)([0-9][0-9][13579][26]))				

element **Soggetti_Diversi_Da_PF_Type/FinePeriodoImposta**

diagram					
namespace	urn:www.agenziaentrate.gov.it:specificheTecniche:sco:common				
type	DatoDT_Type				
facets	<table border="1"> <tr> <td>Kind</td> <td>Value</td> </tr> <tr> <td>pattern</td> <td>(((0[1-9][12][0-9]3[01])(0[13578]10 12)\d{4})) ((0[1-9][12][0-9]30)(0[469]11)\d{4})) ((0[1-9]1[0-9]2[0-8])(02)\d{4})) ((29)(02)([02468][048]00)) ((29)(02)([13579][26]00)) ((29)(02)([0-9][0-9][0][48])) ((29)(02)([0-9][0-9][2468][048])) ((29)(02)([0-9][0-9][13579][26]))</td> </tr> </table>	Kind	Value	pattern	(((0[1-9][12][0-9]3[01])(0[13578]10 12)\d{4})) ((0[1-9][12][0-9]30)(0[469]11)\d{4})) ((0[1-9]1[0-9]2[0-8])(02)\d{4})) ((29)(02)([02468][048]00)) ((29)(02)([13579][26]00)) ((29)(02)([0-9][0-9][0][48])) ((29)(02)([0-9][0-9][2468][048])) ((29)(02)([0-9][0-9][13579][26]))
Kind	Value				
pattern	(((0[1-9][12][0-9]3[01])(0[13578]10 12)\d{4})) ((0[1-9][12][0-9]30)(0[469]11)\d{4})) ((0[1-9]1[0-9]2[0-8])(02)\d{4})) ((29)(02)([02468][048]00)) ((29)(02)([13579][26]00)) ((29)(02)([0-9][0-9][0][48])) ((29)(02)([0-9][0-9][2468][048])) ((29)(02)([0-9][0-9][13579][26]))				

element **Soggetti_Diversi_Da_PF_Type/Stato**

diagram									
namespace	urn:www.agenziaentrate.gov.it:specificheTecniche:sco:common								
type	Stato_Type								
facets	<table border="1"> <tr> <td>Kind</td> <td>Value</td> </tr> <tr> <td>pattern</td> <td>[1-9]{1}[0-9]*</td> </tr> <tr> <td>enumeration</td> <td>1</td> </tr> <tr> <td>enumeration</td> <td>2</td> </tr> </table>	Kind	Value	pattern	[1-9]{1}[0-9]*	enumeration	1	enumeration	2
Kind	Value								
pattern	[1-9]{1}[0-9]*								
enumeration	1								
enumeration	2								

enumeration	3
enumeration	4

element **Soggetti Diversi Da PF_Type/NaturaGiuridica**

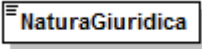
diagram		
namespace	urn:www.agenziaentrate.gov.it:specificheTecniche:sco:common	
type	Natura Giuridica Type	
facets	Kind	Value
	pattern	[1-9]{1}[0-9]*
	enumeration	1
	enumeration	2
	enumeration	3
	enumeration	4
	enumeration	5
	enumeration	6
	enumeration	7
	enumeration	8
	enumeration	9
	enumeration	10
	enumeration	11
	enumeration	12
	enumeration	13
	enumeration	14
	enumeration	15
	enumeration	16
	enumeration	17
	enumeration	18
	enumeration	19
	enumeration	20
	enumeration	21
	enumeration	22
	enumeration	23
	enumeration	24
	enumeration	25
	enumeration	26
	enumeration	27
	enumeration	28
	enumeration	29
	enumeration	30
	enumeration	31
	enumeration	32
	enumeration	33
	enumeration	34
	enumeration	35
	enumeration	36
	enumeration	37
	enumeration	38
	enumeration	39
	enumeration	40
	enumeration	41
	enumeration	42
	enumeration	43
	enumeration	44
	enumeration	45
	enumeration	50
	enumeration	51
	enumeration	52
	enumeration	53
	enumeration	54
	enumeration	55
	enumeration	56
	enumeration	57

enumeration	58
enumeration	59

element **Soggetti Diversi Da PF_Type/Situazione**

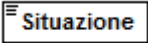
diagram																			
namespace	urn:www.agenziaentrate.gov.it:specificheTecniche:sco:common																		
type	Situazione_Type																		
facets	<table border="1"> <thead> <tr> <th>Kind</th> <th>Value</th> </tr> </thead> <tbody> <tr> <td>pattern</td> <td>[1-9]{1}[0-9]*</td> </tr> <tr> <td>enumeration</td> <td>1</td> </tr> <tr> <td>enumeration</td> <td>2</td> </tr> <tr> <td>enumeration</td> <td>3</td> </tr> <tr> <td>enumeration</td> <td>4</td> </tr> <tr> <td>enumeration</td> <td>5</td> </tr> <tr> <td>enumeration</td> <td>6</td> </tr> <tr> <td>enumeration</td> <td>7</td> </tr> </tbody> </table>	Kind	Value	pattern	[1-9]{1}[0-9]*	enumeration	1	enumeration	2	enumeration	3	enumeration	4	enumeration	5	enumeration	6	enumeration	7
Kind	Value																		
pattern	[1-9]{1}[0-9]*																		
enumeration	1																		
enumeration	2																		
enumeration	3																		
enumeration	4																		
enumeration	5																		
enumeration	6																		
enumeration	7																		

complexType **Soggetti Non Residenti_Type**

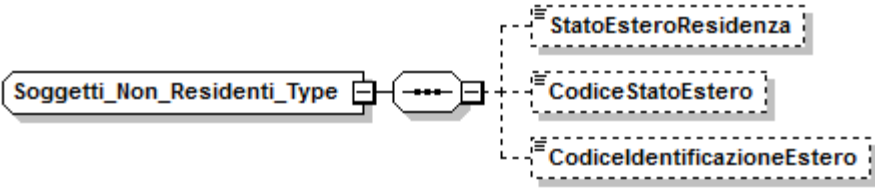
diagram	
namespace	urn:www.agenziaentrate.gov.it:specificheTecniche:sco:common
children	StatoEsteroResidenza CodiceStatoEstero CodiceIdentificazioneEstero

element **Soggetti Non Residenti_Type/StatoEsteroResidenza**

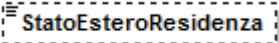
diagram					
namespace	urn:www.agenziaentrate.gov.it:specificheTecniche:sco:common				
type	DatoAN_Type				
facets	<table border="1"> <thead> <tr> <th>Kind</th> <th>Value</th> </tr> </thead> <tbody> <tr> <td>pattern</td> <td>(([0-9A-Z\-\- &quot;]{1})([0-9A-Z&amp;] ' \" _ . / ^ ^\(\\) À È É Ì Ò Ù Ú &quot; \\ / +)*</td> </tr> </tbody> </table>	Kind	Value	pattern	(([0-9A-Z\-\- "]{1})([0-9A-Z&] ' \" _ . / ^ ^\(\\) À È É Ì Ò Ù Ú " \\ / +)*
Kind	Value				
pattern	(([0-9A-Z\-\- "]{1})([0-9A-Z&] ' \" _ . / ^ ^\(\\) À È É Ì Ò Ù Ú " \\ / +)*				

element **Soggetti Non Residenti_Type/CodiceStatoEstero**

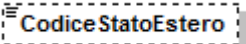
diagram					
namespace	urn:www.agenziaentrate.gov.it:specificheTecniche:sco:common				
type	DatoAN_Type				
facets	<table border="1"> <thead> <tr> <th>Kind</th> <th>Value</th> </tr> </thead> <tbody> <tr> <td>pattern</td> <td>(([0-9A-Z\-\- &quot;]{1})([0-9A-Z&amp;] ' \" _ . / ^ ^\(\\) À È É Ì Ò Ù Ú &quot; \\ / +)*</td> </tr> </tbody> </table>	Kind	Value	pattern	(([0-9A-Z\-\- "]{1})([0-9A-Z&] ' \" _ . / ^ ^\(\\) À È É Ì Ò Ù Ú " \\ / +)*
Kind	Value				
pattern	(([0-9A-Z\-\- "]{1})([0-9A-Z&] ' \" _ . / ^ ^\(\\) À È É Ì Ò Ù Ú " \\ / +)*				

element **Soggetti_Non_Residenti_Type/CodicIdentificazioneEstero**

diagram	
namespace	urn:www.agenziaentrate.gov.it:specificheTecniche:sco:common
type	DatoAN_Type
facets	Kind Value pattern ([0-9A-Z\-\] \"){1}([0-9A-Z&:] \- \., / \^\(\ \)\ À É È Ì Ò Ù Ú \" \ \\ \ +)*

complexType **Soggetto_Fiscale_Type**

diagram	
namespace	urn:www.agenziaentrate.gov.it:specificheTecniche:sco:common
children	CodiceFiscale Email Telefono Fax

element **Soggetto_Fiscale_Type/CodiceFiscale**

diagram	
namespace	urn:www.agenziaentrate.gov.it:specificheTecniche:sco:common
type	DatoCF_Type
facets	Kind Value pattern [0-9]{11}[A-Z]{6}[0-9LMNPQRSTU]{2}[A-Z]{1}[0-9LMNPQRSTU]{2}[A-Z]{1}[0-9LMNPQRSTU]{3}[A-Z]{1}

element **Soggetto_Fiscale_Type/Email**

diagram	
namespace	urn:www.agenziaentrate.gov.it:specificheTecniche:sco:common
type	DatoEM_Type
facets	Kind Value pattern [a-zA-Z0-9._%'\"?^~=]+@[a-zA-Z0-9.\-]+\.[a-zA-Z]{2,4}

element **Soggetto_Fiscale_Type/Telefono**

diagram	
---------	--

namespace	urn:www.agenziaentrate.gov.it:specificheTecniche:sco:common
type	DatoTL_Type
facets	Kind Value pattern [0-9]*

element **Soggetto_Fiscale_Type/Fax**

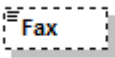
diagram	
namespace	urn:www.agenziaentrate.gov.it:specificheTecniche:sco:common
type	DatoTL_Type
facets	Kind Value pattern [0-9]*

complexType **Tipo_Dichiarazione_Type**

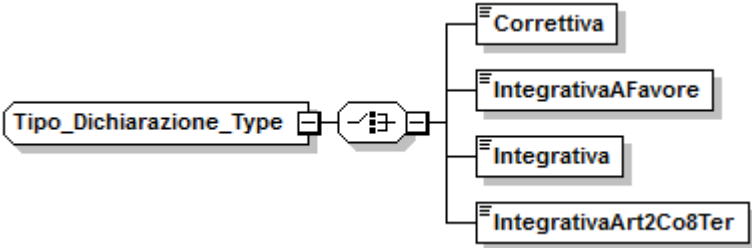
diagram	
namespace	urn:www.agenziaentrate.gov.it:specificheTecniche:sco:common
children	Correttiva IntegrativaAFavore Integrativa IntegrativaArt2Co8Ter

element **Tipo_Dichiarazione_Type/Correttiva**

diagram	
namespace	urn:www.agenziaentrate.gov.it:specificheTecniche:sco:common
type	DatoCB_Type
facets	Kind Value pattern [01]

element **Tipo_Dichiarazione_Type/IntegrativaAFavore**

diagram	
namespace	urn:www.agenziaentrate.gov.it:specificheTecniche:sco:common
type	DatoCB_Type
facets	Kind Value pattern [01]

element Tipo_Dichiarazione_Type/Integrativa

diagram	
namespace	urn:www.agenziaentrate.gov.it:specificheTecniche:sco:common
type	DatoCB_Type
facets	Kind Value pattern [01]

element Tipo_Dichiarazione_Type/IntegrativaArt2Co8Ter

diagram	
namespace	urn:www.agenziaentrate.gov.it:specificheTecniche:sco:common
type	DatoCB_Type
facets	Kind Value pattern [01]

complexType Visto_Conformita_Type

diagram	
namespace	urn:www.agenziaentrate.gov.it:specificheTecniche:sco:common
children	VistoCAF CFprofessionista Firma

element Visto_Conformita_Type/VistoCAF

diagram	
namespace	urn:www.agenziaentrate.gov.it:specificheTecniche:sco:common
children	CFResp CF_CAF

element Visto_Conformita_Type/VistoCAF/CFResp

diagram	
namespace	urn:www.agenziaentrate.gov.it:specificheTecniche:sco:common
type	DatoCF_Type

facets	Kind	Value
	pattern	[0-9]{11}[A-Z]{6}[0-9LMNPQRSTUVWXYZ]{2}[A-Z]{1}[0-9LMNPQRSTUVWXYZ]{2}[A-Z]{1}[0-9LMNPQRSTUVWXYZ]{3}[A-Z]{1}

element **Visto_Conformita_Type/VistoCAF/CF_CAF**

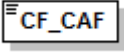
diagram		
namespace	urn:www.agenziaentrate.gov.it:specificheTecniche:sco:common	
type	DatoCN_Type	
facets	Kind	Value
	pattern	[0-9]{11}

element **Visto_Conformita_Type/CFprofessionista**

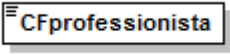
diagram		
namespace	urn:www.agenziaentrate.gov.it:specificheTecniche:sco:common	
type	DatoCF_Type	
facets	Kind	Value
	pattern	[0-9]{11}[A-Z]{6}[0-9LMNPQRSTUVWXYZ]{2}[A-Z]{1}[0-9LMNPQRSTUVWXYZ]{2}[A-Z]{1}[0-9LMNPQRSTUVWXYZ]{3}[A-Z]{1}

element **Visto_Conformita_Type/Firma**

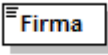
diagram		
namespace	urn:www.agenziaentrate.gov.it:specificheTecniche:sco:common	
type	DatoCB_Type	
facets	Kind	Value
	pattern	[01]

simpleType **Estero**

namespace	urn:www.agenziaentrate.gov.it:specificheTecniche:common	
type	restriction of xs:string	
facets	Kind	Value
	enumeration	EE

simpleType **PE_Type**

namespace	urn:www.agenziaentrate.gov.it:specificheTecniche:common
type	union of (ProvinciItaliane , Estero)

simpleType **PN_Type**

namespace	urn:www.agenziaentrate.gov.it:specificheTecniche:common
-----------	---

type	union of (ProvincieItaliane , ProvincieCroate , Estero , ProvincieSoppresse)
------	--

simpleType PR_Type

namespace	urn:www.agenziaentrate.gov.it:specificheTecniche:common
type	union of (ProvincieItaliane)

simpleType ProvincieCroate

namespace	urn:www.agenziaentrate.gov.it:specificheTecniche:common								
type	restriction of xs:string								
facets	<table border="1"> <thead> <tr> <th>Kind</th> <th>Value</th> </tr> </thead> <tbody> <tr> <td>enumeration</td> <td>FU</td> </tr> <tr> <td>enumeration</td> <td>PL</td> </tr> <tr> <td>enumeration</td> <td>ZA</td> </tr> </tbody> </table>	Kind	Value	enumeration	FU	enumeration	PL	enumeration	ZA
Kind	Value								
enumeration	FU								
enumeration	PL								
enumeration	ZA								

simpleType ProvincieItaliane

namespace	urn:www.agenziaentrate.gov.it:specificheTecniche:common																																																																														
type	restriction of xs:string																																																																														
facets	<table border="1"> <thead> <tr> <th>Kind</th> <th>Value</th> </tr> </thead> <tbody> <tr><td>enumeration</td><td>AG</td></tr> <tr><td>enumeration</td><td>AL</td></tr> <tr><td>enumeration</td><td>AN</td></tr> <tr><td>enumeration</td><td>AO</td></tr> <tr><td>enumeration</td><td>AP</td></tr> <tr><td>enumeration</td><td>AQ</td></tr> <tr><td>enumeration</td><td>AR</td></tr> <tr><td>enumeration</td><td>AT</td></tr> <tr><td>enumeration</td><td>AV</td></tr> <tr><td>enumeration</td><td>BA</td></tr> <tr><td>enumeration</td><td>BG</td></tr> <tr><td>enumeration</td><td>BI</td></tr> <tr><td>enumeration</td><td>BL</td></tr> <tr><td>enumeration</td><td>BN</td></tr> <tr><td>enumeration</td><td>BO</td></tr> <tr><td>enumeration</td><td>BR</td></tr> <tr><td>enumeration</td><td>BS</td></tr> <tr><td>enumeration</td><td>BT</td></tr> <tr><td>enumeration</td><td>BZ</td></tr> <tr><td>enumeration</td><td>CA</td></tr> <tr><td>enumeration</td><td>CB</td></tr> <tr><td>enumeration</td><td>CE</td></tr> <tr><td>enumeration</td><td>CH</td></tr> <tr><td>enumeration</td><td>CI</td></tr> <tr><td>enumeration</td><td>CL</td></tr> <tr><td>enumeration</td><td>CN</td></tr> <tr><td>enumeration</td><td>CO</td></tr> <tr><td>enumeration</td><td>CR</td></tr> <tr><td>enumeration</td><td>CS</td></tr> <tr><td>enumeration</td><td>CT</td></tr> <tr><td>enumeration</td><td>CZ</td></tr> <tr><td>enumeration</td><td>EN</td></tr> <tr><td>enumeration</td><td>FC</td></tr> <tr><td>enumeration</td><td>FE</td></tr> <tr><td>enumeration</td><td>FG</td></tr> <tr><td>enumeration</td><td>FI</td></tr> <tr><td>enumeration</td><td>FM</td></tr> <tr><td>enumeration</td><td>FR</td></tr> </tbody> </table>	Kind	Value	enumeration	AG	enumeration	AL	enumeration	AN	enumeration	AO	enumeration	AP	enumeration	AQ	enumeration	AR	enumeration	AT	enumeration	AV	enumeration	BA	enumeration	BG	enumeration	BI	enumeration	BL	enumeration	BN	enumeration	BO	enumeration	BR	enumeration	BS	enumeration	BT	enumeration	BZ	enumeration	CA	enumeration	CB	enumeration	CE	enumeration	CH	enumeration	CI	enumeration	CL	enumeration	CN	enumeration	CO	enumeration	CR	enumeration	CS	enumeration	CT	enumeration	CZ	enumeration	EN	enumeration	FC	enumeration	FE	enumeration	FG	enumeration	FI	enumeration	FM	enumeration	FR
Kind	Value																																																																														
enumeration	AG																																																																														
enumeration	AL																																																																														
enumeration	AN																																																																														
enumeration	AO																																																																														
enumeration	AP																																																																														
enumeration	AQ																																																																														
enumeration	AR																																																																														
enumeration	AT																																																																														
enumeration	AV																																																																														
enumeration	BA																																																																														
enumeration	BG																																																																														
enumeration	BI																																																																														
enumeration	BL																																																																														
enumeration	BN																																																																														
enumeration	BO																																																																														
enumeration	BR																																																																														
enumeration	BS																																																																														
enumeration	BT																																																																														
enumeration	BZ																																																																														
enumeration	CA																																																																														
enumeration	CB																																																																														
enumeration	CE																																																																														
enumeration	CH																																																																														
enumeration	CI																																																																														
enumeration	CL																																																																														
enumeration	CN																																																																														
enumeration	CO																																																																														
enumeration	CR																																																																														
enumeration	CS																																																																														
enumeration	CT																																																																														
enumeration	CZ																																																																														
enumeration	EN																																																																														
enumeration	FC																																																																														
enumeration	FE																																																																														
enumeration	FG																																																																														
enumeration	FI																																																																														
enumeration	FM																																																																														
enumeration	FR																																																																														

enumeration	GE
enumeration	GO
enumeration	GR
enumeration	IM
enumeration	IS
enumeration	KR
enumeration	LC
enumeration	LE
enumeration	LI
enumeration	LO
enumeration	LT
enumeration	LU
enumeration	MB
enumeration	MC
enumeration	ME
enumeration	MI
enumeration	MN
enumeration	MO
enumeration	MS
enumeration	MT
enumeration	NA
enumeration	NO
enumeration	NU
enumeration	OG
enumeration	OR
enumeration	OT
enumeration	PA
enumeration	PC
enumeration	PD
enumeration	PE
enumeration	PG
enumeration	PI
enumeration	PN
enumeration	PO
enumeration	PR
enumeration	PT
enumeration	PU
enumeration	PV
enumeration	PZ
enumeration	RA
enumeration	RC
enumeration	RE
enumeration	RG
enumeration	RI
enumeration	RM
enumeration	RN
enumeration	RO
enumeration	SA
enumeration	SI
enumeration	SO
enumeration	SP
enumeration	SR
enumeration	SS
enumeration	SV
enumeration	TA
enumeration	TE
enumeration	TN
enumeration	TO
enumeration	TP
enumeration	TR
enumeration	TS
enumeration	TV
enumeration	UD
enumeration	VA
enumeration	VB
enumeration	VC
enumeration	VE
enumeration	VI
enumeration	VR

	enumeration	VS
	enumeration	VT
	enumeration	VV

simpleType ProvincieSoppresse

namespace	urn:www.agenziaentrate.gov.it:specificheTecniche:common	
type	restriction of xs:string	
facets	Kind	Value
	enumeration	FO
	enumeration	PS

simpleType Casella_Quadro_Type

namespace	urn:www.agenziaentrate.gov.it:specificheTecniche:sco:common	
type	restriction of DatoAN_Type	
facets	Kind	Value
	pattern	([0-9A-Z\-\]\"){1}([0-9A-Z&] " \- . \ ° °\°\(\)À È É ì ò ù Ü " \ \\ \ +)*
	enumeration	0
	enumeration	1
	enumeration	2
	enumeration	3

simpleType Codice_Carica_Type

namespace	urn:www.agenziaentrate.gov.it:specificheTecniche:sco:common	
type	restriction of DatoNP_Type	
facets	Kind	Value
	pattern	[1-9]{1}[0-9]*
	enumeration	1
	enumeration	2
	enumeration	3
	enumeration	4
	enumeration	5
	enumeration	6
	enumeration	7
	enumeration	8
	enumeration	9
	enumeration	10
	enumeration	11
	enumeration	12
	enumeration	13
	enumeration	14
	enumeration	15

simpleType Codice_Regione_Type

namespace	urn:www.agenziaentrate.gov.it:specificheTecniche:sco:common	
type	restriction of DatoAN_Type	
facets	Kind	Value
	pattern	([0-9A-Z\-\]\"){1}([0-9A-Z&] " \- . \ ° °\°\(\)À È É ì ò ù Ü " \ \\ \ +)*
	enumeration	1
	enumeration	2
	enumeration	3
	enumeration	4
	enumeration	5
	enumeration	6

enumeration	7
enumeration	8
enumeration	9
enumeration	10
enumeration	11
enumeration	12
enumeration	13
enumeration	14
enumeration	15
enumeration	16
enumeration	17
enumeration	18
enumeration	19
enumeration	20
enumeration	21

simpleType **Natura_Giuridica_Type**

namespace	urn:www.agenziaentrate.gov.it:specificheTecniche:sco:common	
type	restriction of DatoNP_Type	
facets	Kind	Value
	pattern	[1-9]{1}[0-9]*
	enumeration	1
	enumeration	2
	enumeration	3
	enumeration	4
	enumeration	5
	enumeration	6
	enumeration	7
	enumeration	8
	enumeration	9
	enumeration	10
	enumeration	11
	enumeration	12
	enumeration	13
	enumeration	14
	enumeration	15
	enumeration	16
	enumeration	17
	enumeration	18
	enumeration	19
	enumeration	20
	enumeration	21
	enumeration	22
	enumeration	23
	enumeration	24
	enumeration	25
	enumeration	26
	enumeration	27
	enumeration	28
	enumeration	29
	enumeration	30
	enumeration	31
	enumeration	32
	enumeration	33
	enumeration	34
	enumeration	35
	enumeration	36
	enumeration	37
	enumeration	38
	enumeration	39
	enumeration	40
	enumeration	41
	enumeration	42
	enumeration	43
	enumeration	44

DESCRIZIONE DEI CODICI PRESENTI NELLA FORNITURA P7317, RELATIVI ALL'ESITO DELLA RICHIESTA DI MOD. 730 PRECOMPILATI TRAMITE FILE	
MODELLO 730 PRECOMPILATO PRESENTE NELLA FORNITURA P7317	
Valori dell'elemento "stato" presente in "EsitoRichiesta" del file xml di fornitura P7317	Descrizione
300	Per il codice fiscale del contribuente è presente il 730 Precompilato con il relativo prospetto di liquidazione
310	Per il codice fiscale del contribuente è presente il 730 Precompilato ma non è liquidabile
MODELLO 730 PRECOMPILATO NON PRESENTE NELLA FORNITURA P7317	
Valori dell'elemento "stato" presente in "EsitoRichiesta" del file xml di fornitura P7317	Descrizione
055, 355	Il codice fiscale del contribuente non è valido
056	Il codice fiscale del contribuente non è associato ad una persona fisica
057, 357	Il codice fiscale del contribuente non è utilizzabile in quanto aggiornato in altro codice fiscale (*)
059, 359	Verificare la situazione anagrafica del contribuente presso un Ufficio dell'Agenzia delle Entrate (**)
064, 065	Per il codice fiscale del contribuente non risulta presentata nell'anno precedente quella della richiesta alcuna dichiarazione 730 o Unico PF congruente con gli importi indicati nella richiesta
066	Per il codice fiscale del contribuente risulta presentata nell'anno precedente quello della richiesta una dichiarazione 730 o Unico PF e risulta compilato il flag "Assenza di dichiarazione presentata nell'anno precedente"
067	Per il codice fiscale del contribuente il 730 Precompilato è in corso di elaborazione
307	Per il codice fiscale del contribuente non è stato predisposto il 730 Precompilato
308, 311	Per il codice fiscale del contribuente il 730 Precompilato non è disponibile. Per le motivazioni consultare il sito di Assistenza https://assistenza.agenziaentrate.it
058	Per il codice fiscale del contribuente il 730 Precompilato non è disponibile in quanto per il codice fiscale del contribuente non risulta trasmessa nei termini, dal sostituto d'imposta (soggetto richiedente) all'Agenzia delle entrate, la Certificazione Unica 2017 per redditi di lavoro dipendente

Nota (*)

Il codice fiscale indicato non è utilizzabile perché è un cosiddetto “omocodice”, cioè corrispondente ai dati anagrafici di diverse persone. L’Agenzia delle Entrate ha quindi attribuito un nuovo codice fiscale, differente, a ciascuna di esse. Il nuovo codice fiscale è stato comunicato alle persone interessate ed è quello che va utilizzato.

Nota ()**

Nel sistema informativo dell’Agenzia delle Entrate è stata registrata una informazione di avvenuto decesso, associata al codice fiscale indicato. In caso di informazione non corretta, è sempre possibile rivolgersi a un ufficio dell’Agenzia delle Entrate per l’eventuale rettifica.

La situazione in cui ad una stessa descrizione corrispondono due distinti codici, nella generalità dei casi, fa riferimento ai diversi momenti nei quali è stata riscontrata l’anomalia (acquisizione della richiesta ovvero predisposizione della fornitura).